

Temperature Controller

EXPERT SERIES 2 BASIC

USER'S MANUAL

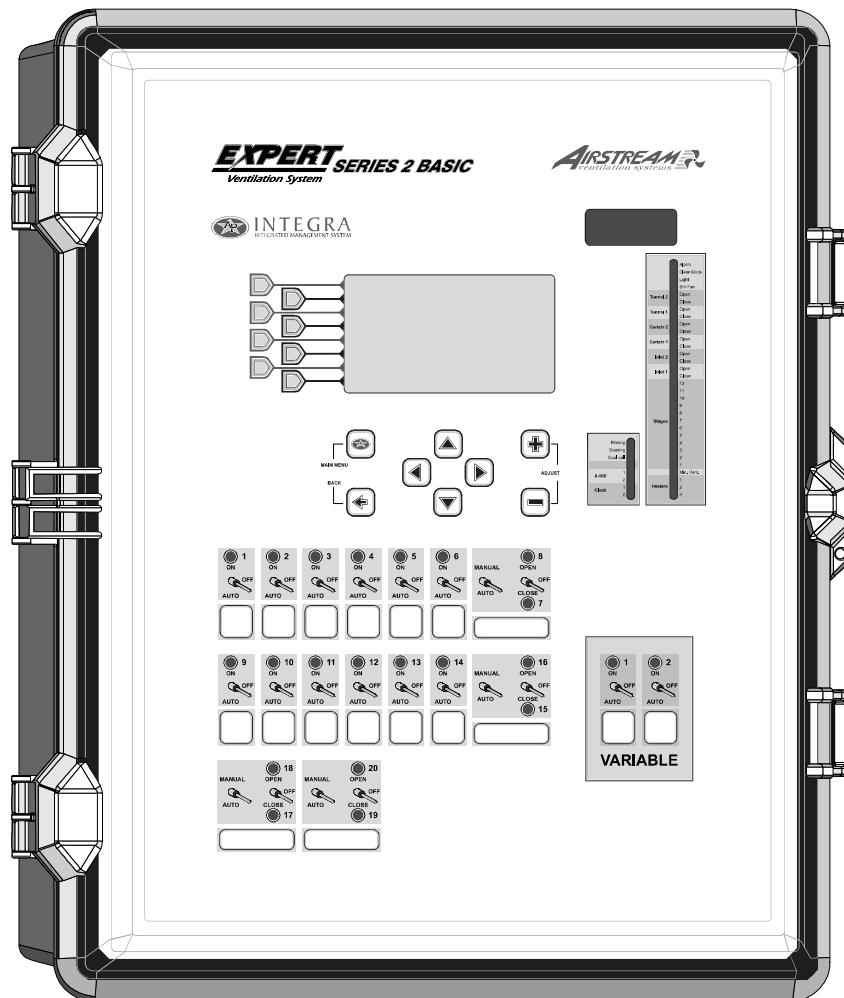

NOTICE

Every effort has been made to ensure that this manual is complete, accurate and up-to-date. The information contained in it is however subject to change without notice due to further developments.

TABLE OF CONTENTS

1. INTRODUCTION	6
1.1 Precautions	6
1.2 Symbols of the Manual	6
1.3 Controller's Overview	7
2. MOUNTING INSTRUCTIONS	10
2.1 Installing the Controller on the Wall	10
2.2 Connections	10
2.2.1 Main Wiring	10
2.2.2 Alarm Connection	10
2.2.3 Sensor Inputs	10
2.2.4 0-10V Output Connection	10
3. USER INTERFACE	11
3.1 Location of the Controls	11
3.2 Parameter Adjustment	12
3.3 Language Selection	12
3.4 LED Meaning	13
4. INSTALLATION SETUP	14
4.1 Setting the Time & Date	14
4.2 Password	14
4.2.1 Entering/Changing the Password	15
4.2.2 Retrieving a Lost Password	15
4.3.1 Program Selection & Settings	16
4.3 Controller Programs	16
4.3.2 Copying & Pasting Programs	17
4.4 Measuring Units	18
4.5 Installation Setup	19
4.6 RH Compensation Setup	24
4.7 Probe Setup	25
4.7.1 Probe Activation	25
4.7.2 Probe & Water Meter Calibration	26
4.7.3 Probe Assignment	27
4.8 Relay Assignment	28
4.8.1 Assigning Relays to the Outputs	28
4.8.2 Assigning Min. Ventilation Relays	29
4.9 Variable Output Assignment	29
4.10 Night Settings	30
4.11 Clean Mode	31
4.12 Test Mode	32
4.13 Version	32

5	TEMPERATURE SETTINGS	33
5.1	Temperature Set Point	33
5.2	Temperature Curve	34
5.2.1	Principle of Operation	34
5.2.2	Settings	34
5.2.3	Modifying Curve Points	35
6.	VENTILATION & COOLING	36
6.1	Minimum Ventilation	36
6.1.1	Minimum Ventilation Cycles	36
6.1.2	Minimum Speed Curve	38
6.1.3	Modifying Curve Points	39
6.2	Fan Stages	40
6.2.1	Principle of Operation	40
6.2.1.1	Operation of Fan Stages	40
6.2.1.2	Operation of Variable Outputs	40
6.2.1.3	Stage 1 Ramping	42
6.2.2	Fan Stage Settings	43
6.2.3	0-10V Ventilation Outputs	44
6.3	Natural Ventilation Curtains	45
6.3.1	Principle of Operation	45
6.3.2	Natural Ventilation Settings	46
6.3.3	Curtain Compensation	47
6.3.4	Stopping Fans in Natural Vent.	47
6.4	Tunnel Doors	48
6.5	Timer-based Air Inlets	50
6.5.1	Principle of Operation	50
6.5.2	Timer-based Inlet Settings	52
6.5.3	Resetting the Actuator's Position	53
6.6	Air Inlets with Potentiometer	54
6.6.1	Principle of Operation	54
6.6.2	Potentiometer Inlet Settings	55
6.6.3	Inlet Calibration	56
6.7	0-10V Air Inlets	57
6.8	Cool Cells	58
6.9	Misting Output	59
6.10	Stir Fans	61
7.	HEATING	63
7.1	Heating Stages	63
7.2	Heat Lamps (0-10V)	64
7.3	Heat Mats (0-10V)	65

EXPERT SERIES 2 BASIC

8.	LIGHTS	66
9.	CLOCK OUTPUTS	66
10.	RH COMPENSATION	68
11.	SOAKING	71
12.	ALARMS	72
12.1	Alarm Log	72
12.2	Alarm Conditions	73
12.3	Alarm Settings	74
13.	MONITORING FUNCTIONS	75
13.1	Current Conditions	75
13.3	History Menus	76
13.4	Animal Age & Count	77
13.5	Automatic Reminder	78
14.	TECHNICAL SPECIFICATIONS	79
15.	MEMORY CARD	80
15.1	Principle of Operation	80
15.2	Accessing the Transfer Menu	80
15.3	Configuration Transfer	81
15.3.1	Installing a New Configuration	81
15.3.2	Saving a Configuration on the Card	81
15.4	Firmware Update	82
15.5	Erasing the Memory Card	82
16.	WORK SHEETS	83
16.1	Relay Assignment Template	84
16.3	Installation Setup Worksheet	87
16.2	Probe Assignment Worksheet	87
INDEX	89

1. INTRODUCTION

1.1 Precautions

We strongly recommend installing supplementary natural ventilation as well as a backup thermostat on at least one cooling stage (refer to the relay panels' wiring diagram to connect the thermostat).

Although fuses at the input and outputs of the controller protect its circuits in case of an overload or overvoltage, we recommend installing an additional protection device on the controller's supply circuit.

The room temperature where the controller is located must always remain between 32°F and 104°F (0°C TO 40°C). Indoor use only!

To avoid exposing the controller to harmful gases or excessive humidity, it is preferable to install it in a corridor.

If the equipment is used in a manner not specified by the manufacturer, the protection provided by the equipment may be impaired.

Do not spray water on the controller!
In order to clean the control, wipe it with a damp cloth.

1.2 Symbols of the Manual



Caution. Read the following text carefully. It contains important pieces of information which, if ignored, may cause the controller to operate improperly.



Pay attention. The following text contains very useful information.



Press the main menu push-button.



Press the proper menu selector.

1.3 Controller's Overview

The EXPERT SERIES 2 BASIC is an electronic device used for environmental control in livestock buildings. It combines sidewall, natural and tunnel ventilation into one powerful system.

The EXPERT SERIES 2 BASIC can control the following inputs and outputs:

OUTPUTS:

20 built-in relays &

16 optional relays to control:

- 3 heating stages;
- 12 fan stages;
- 2 tunnel doors;
- 2 natural ventilation curtains;
- 2 inlet actuators;
- 1 stir fan output;
- 2 clock outputs;
- 1 misting output;
- 1 cool cell output;
- 1 soaking output;
- 1 light output;
- 2 feeders;
- 1 backup relay;

2 built-in 0-10V outputs to control additional fans, heat mats, heat lamps or inlets;

2 built-in variable speed outputs.

INPUTS:

- 8 inside temperature sensors;
- 2 outside temperature sensors;
- 1 inside humidity sensor;
- 1 outside humidity sensor;
- 1 static pressure probe;
- 9 water meters.



Refer to the wiring diagram enclosed at the end of this manual to connect sensors and loads.

EXPERT SERIES 2 BASIC

MAIN FEATURES:

VERY LARGE LCD DISPLAY

A large LCD screen provides an efficient interface for displaying, monitoring and adjusting the parameters.

3 CONTROLLER PROGRAMS

The controller allows using 3 different programs to control the room temperature. It is thus possible to activate a specific program, that uses particular temperature settings, in accordance with the animal age for instance.

STATUS LEDS

Pilot lights that indicate the status of the controller outputs are located on the faceplate of the controller. These LEDs allow monitoring the system's operation without having to enter the building.

MINIMUM VENTILATION CYCLE

When ventilation is not required to reduce the room temperature, the fan outputs can run either continuously or intermittently to reduce humidity levels and supply oxygen to the room.

8 INDOOR TEMPERATURE SENSORS

Up to eight temperature sensors can be connected to the controller to obtain an accurate reading of the average room temperature and a faster reaction time.

NATURAL VENTILATION CURTAINS

The controller can open 2 natural ventilation curtains and stop all ventilation when the outside temperature is sufficiently warm.

TUNNEL VENTILATION

When the room temperature rises, tunnel ventilation reduces the actual temperature perceived by the animals.

HUMIDITY CONTROL

The inside and outside relative humidity sensors allow controlling humidity levels in the room.

0-10V OUTPUTS

Two 0-10V outputs can be used to control additional variable fan stages, heating devices, and/or inlets.

CONTROL OF THE AIR INLET MOVEMENT

The movement of air inlets can be coordinated with the operation of the fans using a potentiometer located on the panel drive or a timer. This allows the air inlets to be adjusted correctly, without the influence of uncontrollable factors such as wind or air from adjoining rooms

HISTORY MENUS

History menus allow monitoring the sensor readings and verify the run time of some outputs. The controller comes with the following histories menus:

- **Minimum and maximum sensor readings:**
 - Room temperature 60 days
 - Inside temperature sensors 10 days
 - Outside temperature sensor ... 75 days
 - Inside humidity sensor 75 days
 - Outside humidity sensor 75 days
 - Static pressure sensor 75 days
- **Run time of each heater** 75 days
- **Run time of each feeder** 75 days
- **Daily water consumption** 75 days

ALARM MANAGEMENT

The controller provides alarms for high-low temperatures, defective sensors and other system failures. It keeps in memory the 20 most recent alarm conditions.

PASSWORD PROTECTION

A password can be enabled to restrict access to the setup functions of the controller.

BACKUP BATTERY

A backup battery allows the unit to keep time in case of a power failure.

OVERLOAD AND OVERVOLTAGE PROTECTION

Resettable fuses are provided at low-voltage inputs of the controller to protect its circuitry in the case of an overload or overvoltage.

COMPUTER CONTROL

The controller can be connected to a computer, thus making it possible to centralize the management of information and diversify control strategies.

TEST MODE

A test mode allows you to simulate temperature changes and verify controller performances.

2. MOUNTING INSTRUCTIONS

2.1 Installing the Controller on the Wall

Fasten the two metal brackets on the mounting holes located behind the controller using six screws. Then, mount the enclosure on the wall using four other screws. Leave a clearance of at least 16" to the left of the enclosure to allow the cover to be removed for maintenance.

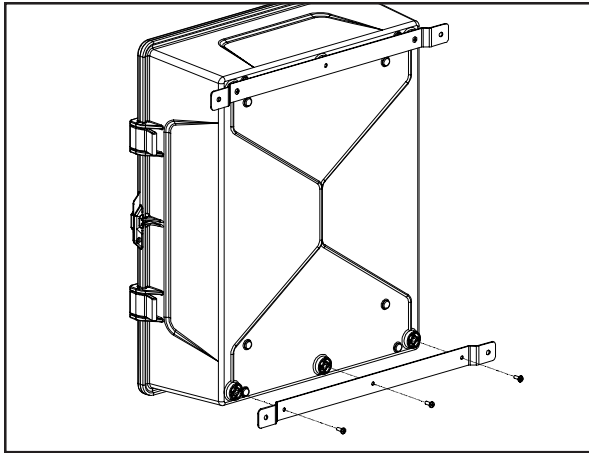

2.2 Connections

2.2.1 Main Wiring

Refer to the wiring diagram enclosed with this user's manual to connect the controller. Drill holes at the bottom of the enclosure to pass the wires and install watertight connectors to prevent water from entering in the enclosure. Do not make any holes at the side and top of the enclosure.



ALL WIRING MUST BE DONE BY AN AUTHORIZED ELECTRICIAN AND MUST COMPLY WITH APPLICABLE CODES, LAWS AND REGULATIONS. MAKE SURE POWER IS OFF BEFORE DOING ANY WIRING TO AVOID ELECTRICAL SHOCKS AND EQUIPMENT DAMAGE.

2.2.2 Alarm Connection

There are two types of alarms on the market. One type activates when current is cut off at its input; the other type of alarm activates when current is supplied at its input. For an alarm of the first type, use the NC terminal as shown on the wiring diagram. For an alarm of the second type, use the NO terminal.

2.2.3 Sensor Inputs

Sensors operate at low voltage and are isolated from the supply. Make sure that sensor cables remain isolated from all high voltage sources. In particular, do not route the sensor cables through the same electrical knockout as other cables. Do not connect the shield from the sensor cable to a terminal or a ground.

Extending a sensor: Each sensor can be extended up to 500 feet (150 meters).

To extend a sensor: Use a shielded cable of outside diameter between 0.245 and 0.260 in (6.22 and 6.60 mm) (the cable dimensions should not be under 18 AWG) to ensure the cable entry is liquid tight. **Do not ground the shielding.**

It is preferable to solder the cable joint to ensure a proper contact between the two cables.



Do not run sensor cables next to other power cables. When crossing over other cables, cross at 90°.

Defective sensors: An alarm is generated when a defective sensor is detected. Defective sensors are identified in the "**Alarm Log**" menu. Refer to chapter 12 for further information on the alarms.

2.2.4 0-10V Output Connection

It is recommended to use a 18 to 22 AWG wire to connect the devices to the 0-10V outputs. This type of output can be used to connect various devices such as heat mats or fans.

3. USER INTERFACE

3.1 Location of the Controls

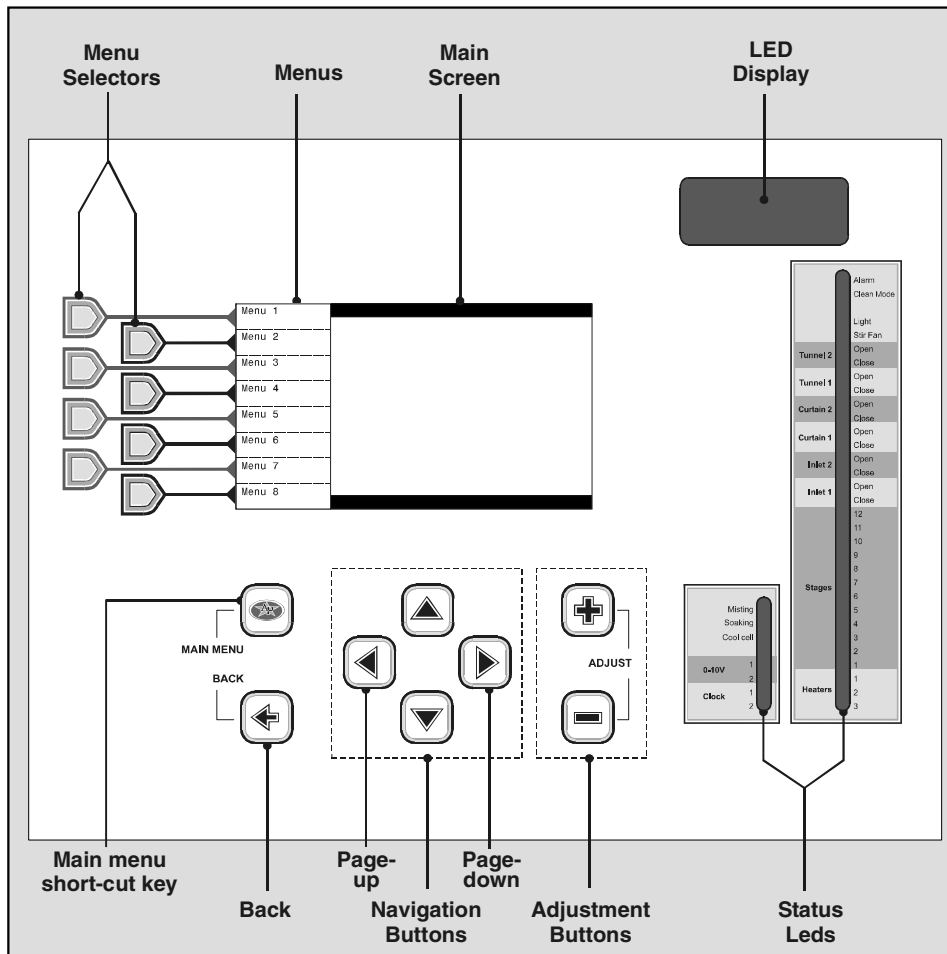

- Menu selectors**
 Use these buttons to select a menu.
- Main menu short-cut key**
 This short-cut key provides access to the main menu and allows seeing the current status of each input and output on the main screen. The main menu is automatically selected after 4 minutes of inactivity.
- Navigation buttons**
 Use these buttons to select an item displayed in the main screen. In addition, the left and right-arrow key are also used to move through the display by pages (left = page-up, right = page-down).
- Adjustment buttons**
 Use these buttons (+ or -) to modify the value of the selected parameter.

EXPERT SERIES 2 BASIC

- **Back**
Press BACK to return to the previous menu.
- **Main LCD Screen**
The large LCD screen is used to display the various parameters and menus. The contrast of the screen can be adjusted using the potentiometer located behind the display. Open the front panel to access the potentiometer (see picture on the right).
- **LED Display**
This display shows the current reading of chosen sensor(s). Refer to section 4.5 to select what information needs to be shown on the LED display.
- **Status Leds**
Status pilot lights indicate the current status of the outputs. Refer to section 3.4 for further information about these LEDs.
- **Backlight button**
Press this button to light up the LCD screen.

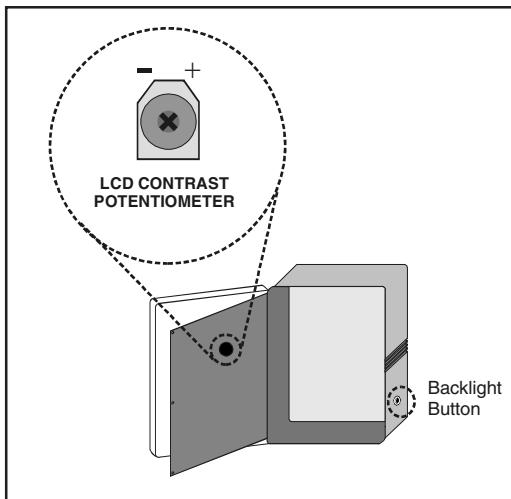



3.2 Parameter Adjustment

Use the navigation buttons to select the desired parameter on the main screen. A parameter that can be modified blinks when it is selected; non-blinking parameters cannot be changed.

3.3 Language Selection

The user interface of the controller can be displayed in multiple languages. Follow these steps to change the language selection:

Select:

-  Main menu
-  More [Otros]
-  Español [English]

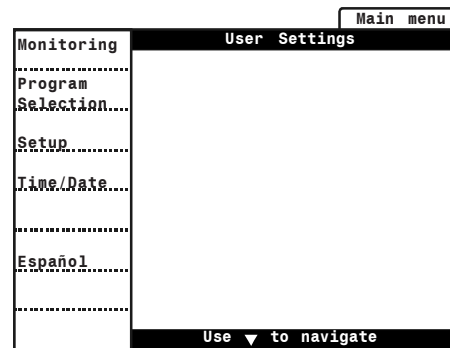

- The controller automatically changes the language display.



Press and hold the main menu button for 5 seconds to switch the language selection.

EXPERT SERIES 2 BASIC



3.4 LED Meaning

LED	MEANING
CLEAN MODE	Solid LED: Clean mode is active.
ALARM	Solid LED: An alarm condition is active. A corrective action is required.
	Flashing LED: An alarm condition occurred but no longer exists.
STIR FAN	Solid LED: the stir fan output is active.
TUNNEL 2	Open Solid LED: tunnel door #2 is opening.
	Close Solid LED: tunnel door #2 is closing.
TUNNEL 1	Open Solid LED: tunnel door #1 is opening.
	Close Solid LED: tunnel door #1 is closing.
CURTAIN 2	Open Solid LED: natural ventilation curtain #2 is opening.
	Close Solid LED: natural ventilation curtain #2 is closing.
CURTAIN 1	Open Solid LED: natural ventilation curtain #1 is opening.
	Close Solid LED: natural ventilation curtain #1 is closing.
INLET 2	Open Solid LED: inlet #2 is opening.
	Open Flashing LED: the controller opens inlet #2 to reset the actuator's position.
	Close Solid LED: inlet #2 is closing.
	Close Flashing LED: the controller closes inlet #2 to reset the actuator's position.
INLET 1	Open Solid LED: inlet #1 is opening.
	Open Flashing LED: the controller opens inlet #1 to reset the actuator's position.
	Close Solid LED: inlet #1 is closing.
	Close Flashing LED: the controller closes inlet #1 to reset the actuator's position.
STAGES 1-12	Solid LED: fan stage #x is active.
MINIMUM VENTILATION	Solid LED: On Time of the minimum ventilation timer.
	Flashing LED: Off Time of the minimum ventilation timer.
HEATERS 1-3	Solid LED: heating output #x is active.
MISTING	Solid LED: On Time of the misting timer.
	Flashing LED: Off Time of the misting timer.
SOAKING	Solid LED: On Time of the soaking timer.
	Flashing LED: Off Time of the soaking timer.
COOL CELL	Solid LED: On Time of the cool cell timer.
	Flashing LED: Off Time of the cool cell timer.
0-10V 1-2	Solid LED: 0-10V output #x is active.
CLOCK 1-2	Solid LED: clock output #x is active.

4. INSTALLATION SETUP

4.1 Setting the Time & Date

Select:

-  Main menu
-  Time / Date

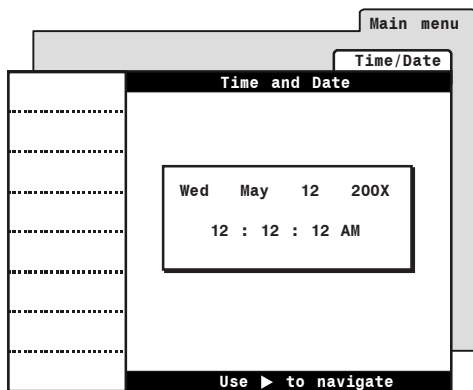

- Press the right-arrow key once. The current day of the week flashes on the display.
- Use the adjustment buttons to adjust the day of the week.
- Press the right-arrow key to step to the next parameter.
- Proceed in similar fashion to set the whole time and date.

4.2 Password

The controller has three levels of password access:

User 1 password [1-1-1-1]

This password provides access to temperature set points, minimum ventilation settings and to the animal count menu. If many password levels are used, the controller automatically selects this user level after 15 minutes of inactivity.

User 2 [2-2-2-2]

This password provides access to all menus except for installation setup menus. This password can be modified as explained below.

Installer password [0-6-1-0]

This password provides access to all functions of the controller. It can be modified as explained below.

Using passwords is optional. Refer to the Installation Setup section of this manual to enable or disable passwords (section 4.5).

Default installer password

0 - 6 - 1 - 0

User 1 Password

1 - 1 - 1 - 1

User 2 Password

2 - 2 - 2 - 2







Refer to the Installation Setup menu to enable/disable the password protection (see sec. 4.5).

EXPERT SERIES 2 BASIC

4.2.1 Entering/Changing the Password

Select:

-  Main menu
-  Setup *
-  User
-  Password

* A password may be required to access this menu.

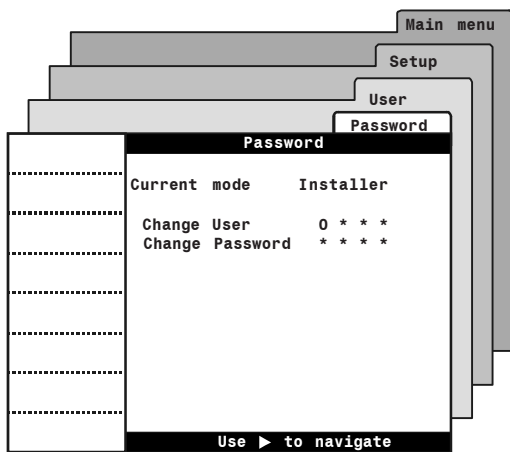

- Use the adjustment buttons to set the first number of the password then press the right-arrow key. Proceed the same way to enter all numbers of the password then press the right-arrow key. The user is then identified.
- If the installation password or user 2 password is posted, the prompt "**Change Password**" appears on screen. Use the adjustment buttons to set the new password code.







IMPORTANT
Choose an easy-to-remember password and write it down in a safe place!

- Use the adjustment buttons to confirm the new installer password then press the right-arrow key to confirm the new password.

4.2.2 Retrieving a Lost Password

Follow these steps to retrieve a lost password:

Select:

-  Main menu
-  Setup *
-  User
-  Password
-  User Password **

* If the controller prompts for a password, enter the factory password (contact your dealer).

** This tab is only accessible from the factory level.

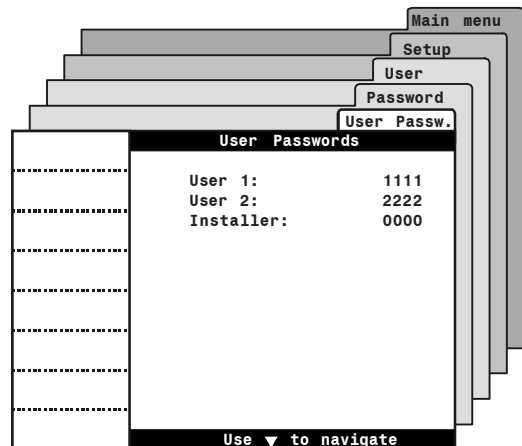

- The actual password of all user levels are displayed on screen.

4.3 Controller Programs

Program definition

Programs are an assembly of settings (temperature settings, relay assignment, probe assignment, etc.) that can be enabled at different moment of the breeding process. In all, the controller can use 3 different programs.

Automatic program selection

The controller can automatically switch the program selection when the animals reach a certain age and/or as a function of outside temperature. Refer to the Installation Setup section of this manual to enable or disable the automatic program switch (see section 4.5).



Refer to the Installation Setup section of this manual to set the number of programs in use and to enable or disable the automatic program switch (section 4.5).

Program selection

When a program is selected, all parameter settings displayed on screen are related to this program.



Make sure the right program is selected before adjusting any parameter.

4.3.1 Program Selection & Settings

The controller can automatically switch the program selection when the animals reach a certain age and/or as a function of outside temperature. If the automatic program switch option is enabled in the Installation setup (sec. 4.5), you must indicate the moment at which each program starts.

Select:

- Main menu
- Setup*
- Program

* A password may be required to access this menu (sec. 4.2).

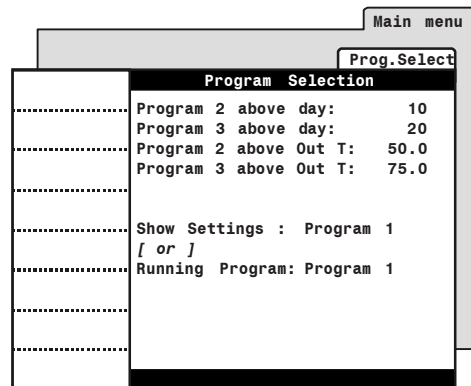

Program #x above:

If the program switch is based on the animal age, select the day at which programs 2 and 3 start; if the switch is based on the outside temperature, select the outside tem-

perature above which each program starts. Note that program 1 is automatically used when the animal age (or outside temperature) is lower than the value defined for programs 2 and 3.

Show settings of:

Even when a program is running you can still display parameter settings of other programs without changing the program in use. Select the desired program to be displayed on screen.

Only programs that are enabled in the Installation Setup are available (see sec. 4.5).

Running program:

This message is shown when the program selection is made manually (i.e., it is not selected as a function of the day and/or outside temperature). Select the running program.

Only programs that are enabled in the Installation Setup are available (see sec. 4.5).





The day number refers to the animal age.

4.3.2 Copying & Pasting Programs

Use the copy-paste function to duplicate all parameter settings associated to a program onto another program. This avoids repeating the same programming sequence several times.

Select:

-  Main menu
-  Setup*
-  Copy/Paste

* A password may be required to access this menu (sec. 4.2).

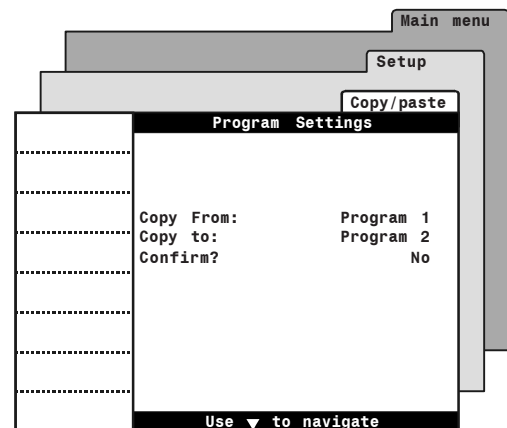





- **Copy From:**
Select the source program. The one that will be duplicated.
- **Copy to:**
Select the target program. The one on which the copied program will be pasted.
- Once a different source and target programs are selected, the message "Confirm?" is displayed. Select "Yes" to start the program duplication. The message "Copy in progress" is displayed. Wait until the data transfer is over.

4.4 Measuring Units

Select the measuring units as follows:

Select:

-  Main menu
-  Setup*
-  User
-  Units

* A password may be required to access this menu (sec. 4.2).

- Select the proper measuring units:

Time display

AM/PM / 24 hours.

Temperature units

Celsius (Deg C) or Fahrenheit (Deg F).

Water

Gallons / Liters.

Static Pressure

Inches of water ("WC) or Pascal (Pa).

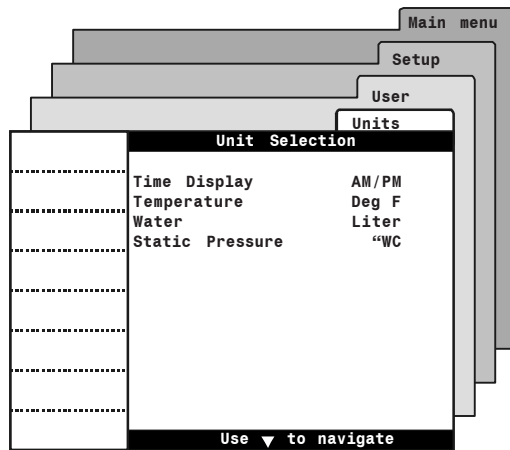

Measuring units are common to all programs of the controller.

4.5 Installation Setup

The following section shows how to customize the controller for your particular application. This section explains how to enable and set the outputs of your controller. Normally, this setup needs to be done only once.

Select:

-  Main menu
-  Setup*
-  User
-  Installation

* A password may be required to access this menu (sec. 4.2).



Hint: use the right and left arrow key to move up and down through the display by pages.

- Set the following parameters:

Number of feeders

The controller has 2 inputs that are used to monitor the run time of feeder motors. Enable the proper number of feeder inputs (0 to 2 feeders).

Number of heating stages

Enable the proper number of heating stages (0 to 3 heating stages).

Number of fan stages

Enable the proper number of fan stages (1 to 12 fan stages).

The number of fan stages is limited by the stage number that signals the beginning of tunnel ventilation. Refer to section 6.4 to select the first tunnel stage.

Number of clock outputs

Enable the proper number of clock outputs (0 to 2 clock outputs).

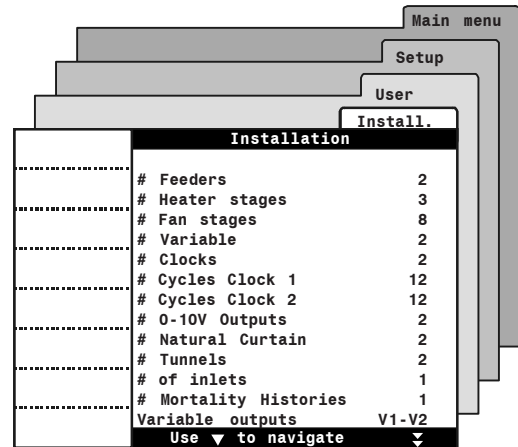

Number of clock cycles

If clock outputs are enabled, select how many timers (cycles) each output uses (1 to 12 cycles).

Number of 0-10V outputs

Enable the proper number of 0-10V outputs (0 to 2 outputs).

Number of natural ventilation curtains

Enable the proper number of natural ventilation curtains (0 to 2 curtains).

Number of tunnel doors

Enable the proper number of tunnel doors (0 to 2 tunnel doors).

Inlet

The controller can control two air inlets. Enable the proper number of inlets.

EXPERT SERIES 2 BASIC

of Mortality history menus

Mortality information can be stored in different mortality history menus. Enable the desired number of mortality history menus (1 to 8 menus).

Variable fan outputs (Ramping)

Select "V1" to enable variable output 1;
Select "V1-V2" to enable var. outputs 1 & 2;
Select "None" to disable variable outputs (if variable fans are not used, the controller will automatically ramp up the fan speed of stage 1 to make a smooth transition between minimum ventilation cycles and fan stage 1).

Inlet mode

Inlet #1 can either operate in timer mode or according to a potentiometer. Select "Pot" to use a potentiometer or select "Timer". Note that the second inlet can only operate in timer mode.

*Accessible if an inlet output is enabled above.
[This parameter is common to all programs].*

Close inlets in natural

Select "Yes" for inlets to close when the controller enters in natural ventilation.

Accessible if natural ventilation curtains and vent inlets are enabled.

0-10V type

Select the type of signal used by each 0-10V output (0-10V or 10-0V).

*Accessible if 0-10V outputs are enabled above.
[This parameter is common to all programs].*

0-10V mode

Select the function of each 0-10V output.

*Accessible if 0-10V outputs are enabled above.
[This parameter is common to all programs].*

- 0-10V ventilation output

When it is used for ventilation, the 0-10V output acts as a fan stage and uses independent temperature settings.

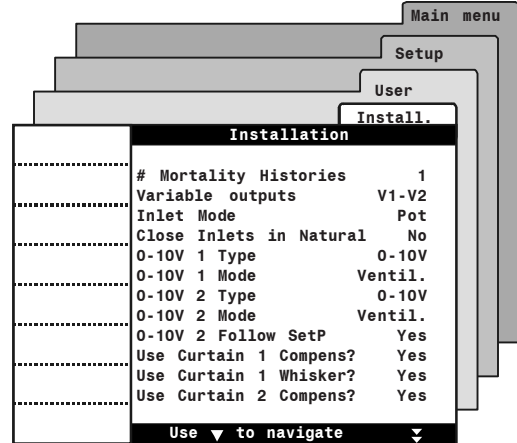

- 0-10V heat mat

When it is used to control heat mats, the 0-10V output is activated at its maximum intensity when the temperature of chosen probes falls below the start temperature of the output.

- 0-10V heat lamp

When it is used to control heat lamps, the 0-10V output starts running at its minimum intensity when the temperature of specific probes falls below the start temperature of the output. The intensity of the heat lamp output increases gradually as the temperature decreases.

- 0-10V inlet

When it is used as an air inlet, the 0-10V opens and closes an actuator as a function of the ventilation level.

0-10V output follows set point

Operating temperatures of 0-10V outputs can either be related to the set point – which means the controller automatically adjusts them when the set point changes – or they can be set as absolute values. Select "Yes"

if they follow the set point or select "No" if they set as absolute values. Set this parameter separately for each 0-10V output.

Accessible if 0-10V outputs are enabled above.

[This parameter is common to all programs].

Curtain Compensation

Select "Yes" to enable a compensation on the opening of natural ventilation curtains as a function of the outside temperature.

Accessible if natural ventilation curtains are enabled above and if an outside temperature sensor is enabled in section 4.7.1.

Whisker switch

Whisker switches are used to tell the controller when natural ventilation curtains are sufficiently opened. Select "Yes" to enable the whisker switch input of each curtain or select "No" if these switches are not used.

[This parameter is common to all programs].

Misting

The controller can control one misting output. Select "Yes" to enable this output.

Misting output follows the set point

Operating temperatures of the misting output can either be set as absolute values or they can be related to the set point. Select "Yes" if they follow the set point or select "No" if they set as absolute values.

Accessible if the misting output is enabled above.

[This parameter is common to all programs].

Cool cells

The controller can control one cool cell output. Select "Yes" to enable this output.

Cool cell output follows the set point

Operating temperatures of the cool cell output can either be set as absolute values or they can be related to the set point. Select "Yes" if they follow the set point or select "No" if they set as absolute values.

Accessible if the cool cell output is enabled above.

[This parameter is common to all programs].

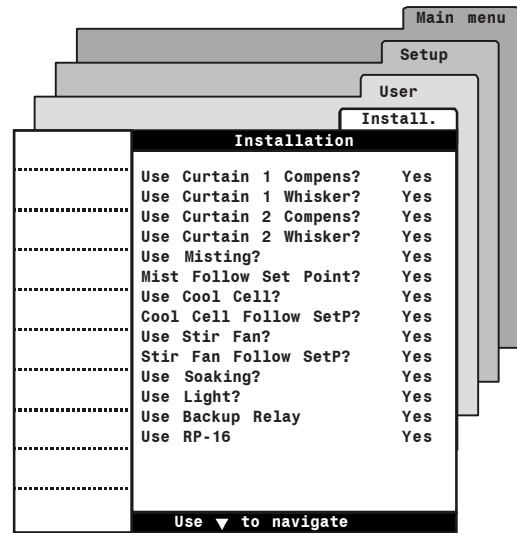

Stir fans

The controller can control one stir fan output. Select "Yes" to enable this output.

Stir fan output follows the set point

Operating temperatures of the stir fan output can either be set as absolute values or they can be related to the set point. Select "Yes" if they follow the set point or select "No" if they set as absolute values.

Accessible if the stir fan output is enabled above.

[This parameter is common to all programs].

Soaking

The controller can control one soaking output. Select "Yes" to enable this output.

Lights

The controller can control one light output. Select "Yes" to enable this output.

Backup relay

The controller can control one backup relay. Select "Yes" to use a backup relay.

[This parameter is common to all programs].

Use RP-16

Select "Yes" if an external relay panel (RP-16) is connected to the controller.

[This parameter is common to all programs].

V1-V2 Min.Spd abs/Inlet % (absolute minimum speed)

Set the absolute minimum speed of both variable outputs (V1 & V2). This parameter also represents the speed at which the inlet opens to its minimum ventilation opening.

*Accessible if variable outputs are enabled above.
[This parameter is common to all programs].*

V1-V2 Motor curves

The relationship between the voltage supplied to a motor and its operating speed is described by a motor curve. This curve varies with the make and capacity of the motor. The various motors available in the industry have been divided into ten categories and the controller has been programmed with a different motor curve for each of these categories. Select the proper motor curve to ensure that the controller supplies the correct voltages according to the type of fan motors used (refer to the motor curve table on the back of the controller's installation guide).

Use age-based functions ?

Some functions of the controller are based on the age of the animals (temperature curve, minimum speed curve & programs). Select "Yes" to use age-based functions or select "No" to disable them.

[This parameter is common to all programs].

Temperature curve

The temperature curve is used to change the temperature set point over time. Select "Yes" to use this curve.

*Accessible if age-based functions are enabled above.
[This parameter is common to all programs].*

Minimum speed curve

The minimum speed curve is used to change minimum ventilation rate over time. Select "Yes" to use this curve.

*Accessible if age-based functions are enabled above.
[This parameter is common to all programs].*

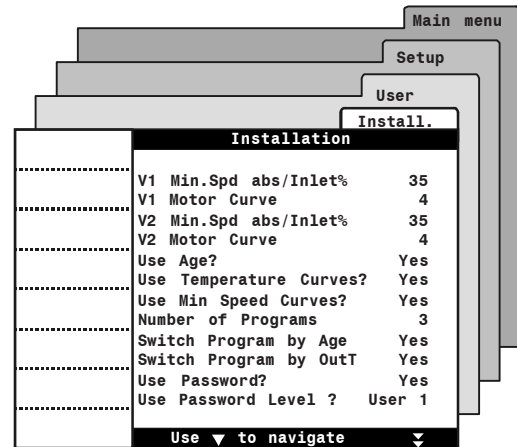

Number of programs

The controller can use several temperature programs. Enable the desired number of programs (1 to 3 programs)

[This parameter is common to all programs].

Switch program by Age / Out T° ?

The controller can automatically enable a new program when the animals reach a certain age and/or as a function of outside temperature. Specify what factor causes a change in the program selection: "Age" and/or "Out T". Answer "No" to both questions if you do not want the controller to change the program automatically.

[These parameters are common to all programs].

Use password?

Select "Yes" to enable the password protection or "No" to disable it.

[This parameter is common to all programs].

Use password level?

Select the default user level used by the controller (user 1, user 2 or installer).

Accessible if the password protection is enabled above. [This parameter is common to all programs].

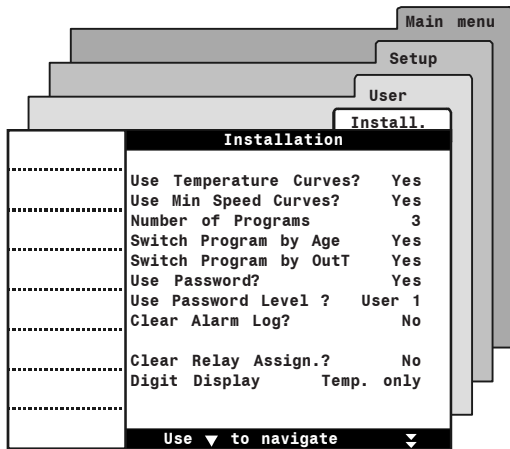

Clear alarms?

Select "Yes" to reset the alarm log.

[This parameter is common to all programs].

Clear Relay Assignment ?

Select "Yes" to clear the assignment between relays and outputs of all programs.

Digit display

Select what piece of information must be shown on the red LED display:

Temp.only:

Temperature only;

Temp/Inlet 1:

Temperature + position of inlet 1.

Temp/Inlet 2:

Temperature + position of inlet 2.





Temp/Inlet 1/Inlet 2:

Temperature + position of inlets 1 & 2

[This parameter is common to all programs].

4.6 RH Compensation Setup

The controller offers different ways to compensate for high and low relative humidity (RH) levels in the barn. This section shows how to enable the desired RH compensation functions.

Select:	
	Main menu
	Setup*
	User
	RH Compens**

* A password may be required to access this menu (sec. 4.2).

** Accessible if a humidity sensor is enabled (sec. 4.7.1)

- Enable or disable the following relative humidity (RH) compensation options:



The following parameters are common to all programs of the controller.

RH compensation on minimum ventilation?

The controller can compensate for high humidity levels by enhancing the minimum ventilation rate. Select "Yes" to use this compensation method.

Accessible if variable outputs are enabled the Installation Setup (sec. 4.5).

RH compensation with heaters

The controller can compensate for high humidity levels by activating heating outputs in timer mode. Select "Yes" to use this compensation method.

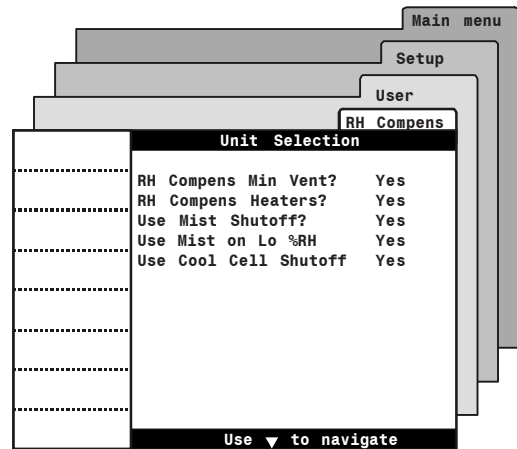

Mist Shutoff

The controller can deactivate the misting output when humidity levels are too high. Select "Yes" to use this compensation method.

Misting on low humidity levels (% RH)

The controller can activate misting outputs when humidity levels are too low. Select "Yes" to use this compensation method.

Cool cell shutoff





The controller can deactivate the cool cell output when humidity levels are too high. Select "Yes" to use this compensation method.

4.7 Probe Setup

4.7.1 Probe Activation

Follow these steps to enable or disable the probe inputs.

Select:

-  Main menu
-  Setup*
-  User
-  Probes

* A password may be required to access this menu (sec. 4.2).

- Enable or disable the following probe inputs:



The following parameters are common to all programs of the controller.

Inside probe

Select the number of inside temperature probes that are connected to the controller (1 to 8 probes).

Inside relative humidity (RH) probe

Select "Yes" if an indoor humidity probe is connected to the controller.

Outside relative humidity (RH) probe

Select "Yes" if an outdoor humidity probe is connected to the controller.

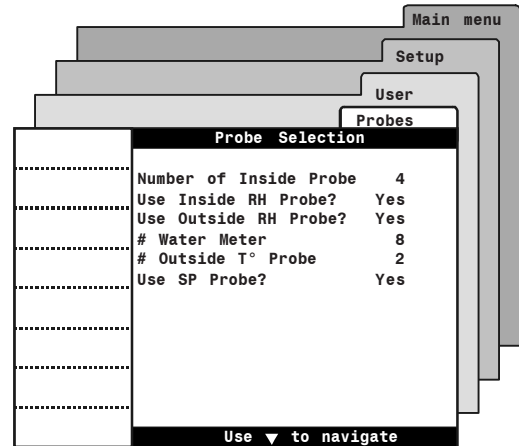

Water meter

Enable the desired number of water meter inputs (1 to 9). Note that the controller only has 1 built-in water meter input. Connect water meters 2-9 to a WME-8 external water meter module.

Outside T°

Select the number of outside temperature probes that are connected to the controller (0 to 2 probes).

Static pressure (SP) probe





Select "Yes" if a static pressure sensor is connected to the controller.

EXPERT SERIES 2 BASIC

4.7.2 Probe & Water Meter Calibration

You can slightly adjust the reading of each probe input in order to obtain accurate and uniform readings from all probes. In addition, if a water meter is used, you must calibrate its water flow rate.

Select:

-  Main menu
-  Setup*
-  User
-  Prb Calib

* A password may be required to access this menu (sec. 4.2).

- Adjust the reading of the probes (if required):



Probe calibration is common to all programs of the controller.

Temperature probes (indoor & outdoor)

The reading of inside and outside temperature probes can be adjusted of $\pm 3^{\circ}\text{F}$ ($\pm 1.7^{\circ}\text{C}$).

Relative humidity probe

The reading of inside and outside humidity probes can be adjusted of $\pm 3\%$.

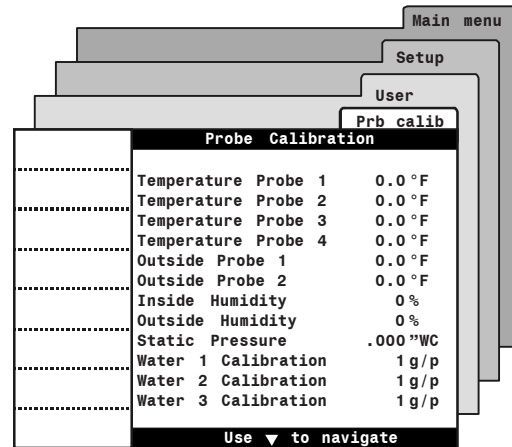

Static pressure probe

The reading of the static pressure probe can be adjusted of $\pm 0.030\text{"WC}$ ($\pm 7\text{Pa}$).

Water meter calibration

Specify the flow rate of each water meter. It can be adjusted from 1 to 100 gallons (or liters) per pulse.

4.7.3 Probe Assignment

Cooling and heating outputs either run according to the room temperature or according to the average reading of chosen temperature probes.

Room Temperature Sensors

Most cooling outputs of the controller (misting output, tunnel fans, stir fans, etc.) operate according to the average temperature in the room. The user must choose what temperature probes are used to measure this room temperature.

Probe Set 2

Settings

This section explain how to select temperature probes that are used to measure the room temperature and how to assign temperature probes that are used to control/ monitor the following outputs:

- Heaters 1-3
- 0-10V outputs
- Natural ventilation curtains



A template is available at the end of this manual to write down your selection of sensors.

Heater 1 Probe Assignment				
1 ---	2 ---	3 ---	4 ---	5 ---
6 ---	7 ---	8 ---		

The selection of probes that is used to measure the room temperature can be changed in tunnel ventilation to compensate for changes in airflow patterns that can distort the room temperature calculation. If the second probe set is enabled in the Installation Setup (sec. 4.5), you must assign temperature probes to this second probe set.

Select:

- ★ Main menu
- ▢ Setup *
- ▢ Probe Assignment
- ▢ Select the desired output ** :
 - Room;
 - Probe Set 2;
 - Heaters 1-3;
 - 0-10V outputs 1-2;
 - Natural ventilation curtain 1-2.

* A password may be required to access this menu (sec. 4.2).

** Only outputs that are enabled in the Setup menu are displayed (sec. 4.5).





- Assign the desired temperature probes to the selected output: select "√" to assign a probe or select "- - -" for probes that are not assigned to the output.

4.8 Relay Assignment

4.8.1 Assigning Relays to the Outputs

You must assign On/Off relays to each output of the controller. Use provided output stickers to identify the function of each relay on the faceplate of the controller.

Select:

-  Main menu
-  Setup*
-  Relay Assignment
-  Select the desired output ** :

* A password may be required to access this menu (sec. 4.2).

** Only outputs that are enabled in the Setup menu are available (sec. 4.5).

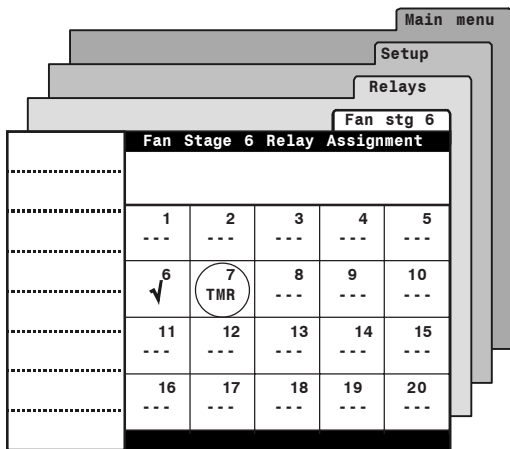

- Select a relay then set its status as follows:

- ✓ The relay is assigned to the output;
- The relay is not assigned to the output;
- TMR:** The load connected to the relay will run in timer mode (available on fan stage outputs only).



Relays 21-36 correspond to relays 1-16 of Airstream Relay Panel 16.

- Proceed in similar fashion to assign relays to each output in use:

- **Fan stages 2-12:**

Fan stages can either activate regular on/off relays and/or **timer-based** relays. When a timer-based relay is assigned to a fan stage, the relay runs in timer mode when the fan stage is active. This is useful to operate misting units for instance. To use timer-based relays, set the relay status to "TMR" (see example above).

- **Tunnel 1-2 / inlet 1-2 / natural curtains 1-2:**

Relays 7-8 and relays 15-20 have specially been designed for the connection of actuators. When actuators are connected to these relays, their open and close relays can never be activated at the same time.

- **Feeding output:**

Feeder relays are used to stop feeders when a feeder run time alarm occurs. These normally closed relays open when the alarm condition is detected.

Accessible if the feeder alarm condition is enabled (section 12.3).

- **Backup relay:**

The backup relay box relay is a normally closed relay which opens in case of a power failure.

- **Shutoff fans in natural ventilation:**

It is possible to shutoff some fan output when the controller enters in natural ventilation (on/off fans and variable fans). Refer to the natural ventilation section of this manual to get further information about this feature.

- **Heating stages 1-3;**

- **Misting output;**

- **Soaking output;**

- **Cool cell output;**

- **Clock outputs 1-2;**

- **Stir fan output;**

- **Light output.**





A template is available at the end of this manual to write down the function of each relay.

EXPERT SERIES 2 BASIC

4.8.2 Assigning Min. Ventilation Relays

This procedure shows how to assign on/off relays to minimum ventilation cycles. Chosen relays will switch during the "On Time" portion of minimum ventilation cycles. Refer to section 6.1 for further information about minimum ventilation cycles.

Select:

-  Main menu
-  Min. Vent.
-  MinV Relays*

* Accessible if the "Minimum Ventilation Relay status" option

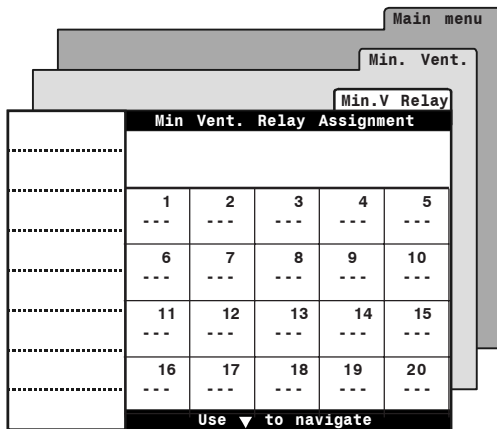

Min. Vent. Relay Assignment				
1	2	3	4	5
---	---	---	---	---
6	7	8	9	10
---	---	---	---	---
11	12	13	14	15
---	---	---	---	---
16	17	18	19	20
---	---	---	---	---

is enabled in section 6.1.1. A password may also be required to access this menu (section 4.2).

- Set the status of each relay: select "✓" if the relay is used in minimum ventilation or select "---" if it is not.



Relays 21-36 correspond to relays 1-16 of Airstream Relay Panel 16.

4.9 Variable Output Assignment

Two variable outputs can be used to provide variable-speed ventilation. If they are used, assign each of them to proper fan stages.

Select:

-  Main menu
-  Setup*
-  Relays
-  Variables**

* A password may be required to access this menu (sec. 4.2).

** Accessible if variable outputs are enabled (sec. 4.5).

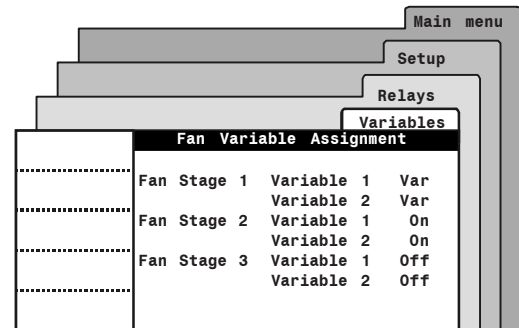

Fan Stage	Variable	Var
Fan Stage 1	Variable 1	Var
	Variable 2	Var
Fan Stage 2	Variable 1	On
	Variable 2	On
Fan Stage 3	Variable 1	Off
	Variable 2	Off

- Set the output status separately for each fan stage in use:

Var: The variable fan output is assigned to the fan stage and operates in **variable mode**: when the stage starts, the variable fan starts running at its minimum intensity. The fan intensity gradually increases as the room temperature increases.

On: The variable fan output is assigned to the fan stage and operates in **on/off mode**: the fan runs at 100% when the fan stage is on and stops when the stage is off.

Off: The variable output is not assigned.







If the last fan stage uses a variable output, the output must use the on/off operating mode. **DO NOT** set the operating mode of the last fan stage to the variable mode.

4.10 Night Settings

Night functions allow changing the target room temperature and the minimum ventilation level when the night comes (refer to the Minimum Ventilation chapter of this manual to set the night fan speed).

Select:

-  Main menu
-  Setup*
-  User
-  Day/Night

* A password may be required to access this menu (sec. 4.2).

- Set the following parameters:

Night Set Point?

Select "Yes" to use a different target temperature at night; select "No" to disable this function.

Night Minimum Ventilation?

Select "Yes" to change the minimum ventilation fan speed at night; select "No" to disable this function.

Day Time

Set the time at which day settings start being used.

Accessible if a night function is enabled above.

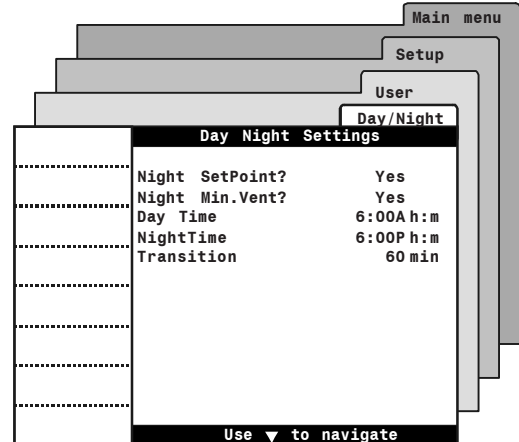

Night Time

Set the time at which night settings start being used.

Accessible if a night function is enabled above.

Transition

If the night set point is enabled above, a transition is made from one set point to the other. Set this transition time to the desired value.

4.11 Clean Mode

The clean mode is used to interrupt regular operations of the controller when the room is empty. When this mode is enabled, the controller simply provides a minimum level of heat and a minimum level of ventilation (optional). While the clean mode is enabled, the letters “CLn” are shown on the LED display.

Cleaning the room

A soaking output can be activated to clean up the room. If this output is used, soaking cycles automatically start when the clean mode is on. Refer to chapter 11 of this manual to get further information about the soaking output.



Clean mode set point

In clean mode, fans that are used to provide minimum ventilation and heaters operate according to the clean mode set point: heaters turn on when the room temperature is lower than the clean mode set point and fans turn on when the temperature is higher than the set point. Refer to section 5.1 to adjust the clean mode set point.

Low temperature alarm

The controller can sound an alarm if the temperature gets too low while the controller is in clean mode. Refer to section 12.3 to set this alarm limit.

Select:

-  Main menu
-  Clean Mode

* A password may be required to access this menu (sec. 4.2).

- Enable the desired clean mode options:

Clean mode status

Select “On” to enable the clean mode; select “Off” to disable it.

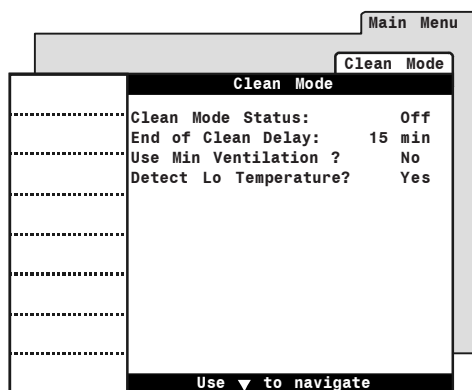

End of clean delay

It is possible to postpone the moment at which the clean mode must end. Select the number of minutes the controller waits to put an end to the clean mode from the moment the clean mode status switches “Off”. The “End of clean delay” can be adjusted from 1 to 300 minutes; select “Off” to disable this function.

Use minimum ventilation?

Select “Yes” to activate minimum ventilation cycles while the clean mode is on.



Detect low temperature?

Select “Yes” to enable the low temperature alarm limit or select “No” to disable this alarm condition.

4.12 Test Mode

The test mode is used to simulate temperature and relative humidity changes and to verify the controller's performances. When it is enabled, all outputs of the controller operate according to the simulated inside and outside temperature and according to the simulated level of relative humidity.

Select:

-  Main menu
-  Setup*
-  Test Mode

* A password may be required to access this menu (sec. 4.2).

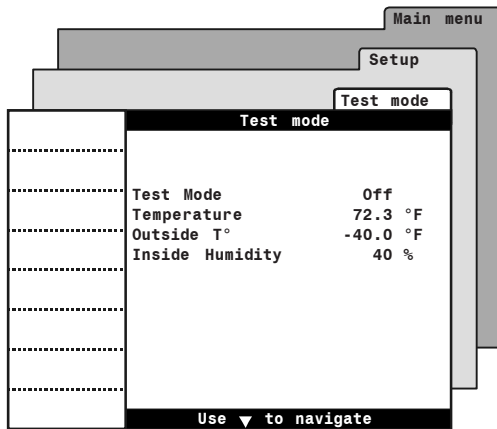

- Switch on the test mode status then set the simulated inside & outside temperature and the humidity level.

The outside temperature and inside humidity factors are only accessible if an outside temperature sensor and humidity sensor are enabled (see sec. 4.7.1).



The test automatically ends after 15 minutes of inactivity. It can also end sooner by switching the test mode status back to "Off".

4.13 Version

This menu shows the version number of your controller program. This piece of information is useful to get technical support.

Select:

-  Main menu
-  Setup*
-  User
-  Version

* A password may be required to access this menu (sec. 4.2).

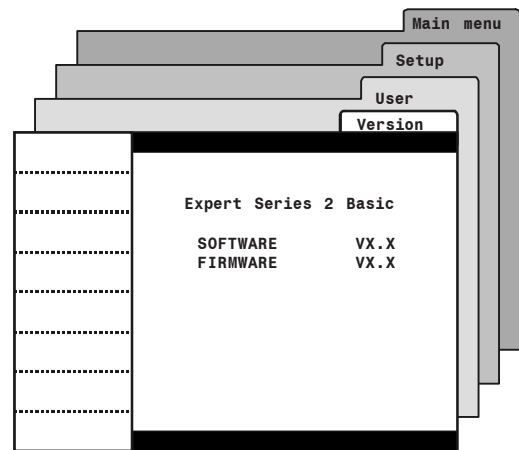



5 TEMPERATURE SETTINGS

5.1 Temperature Set Point

The set point is a target temperature in the room. The activation of most outputs of the controller is based on this reference temperature.

Select:

-  Main menu
-  Set Point

- The following set points are displayed:



Set point settings are common to all programs of the controller.

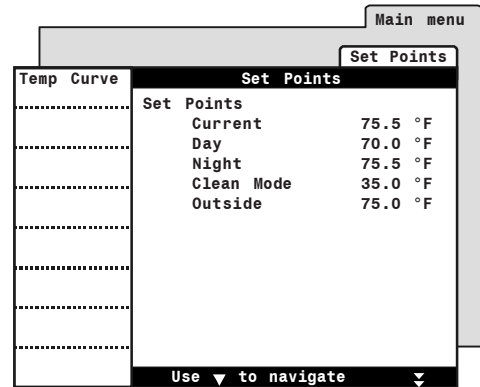

Temp Curve	Set Points	Set Points
	Set Points	
	Current	75.5 °F
	Day	70.0 °F
	Night	75.5 °F
	Clean Mode	35.0 °F
	Outside	75.0 °F
	Use ▼ to navigate ▼	

Current set point

This is the current temperature set point in use. This value cannot be changed; to modify the set point, change the day or night set points below.

Day set point

Set the temperature set point that is used during the day (this set point is used all day long if the night set point is not enabled). The controller can also change the day set point automatically over time by using a curve (see section 5.2).

This parameter can only be modified while the temperature curve is inactive (sec. 5.2).

Night set point

A different temperature set point can be used at night. The night set point can be used to lower the target room temperature for instance. The night set point is relative to

the day set point, which means that it is automatically adjusted when the day set point changes. Set the night set point to the desired value.

Accessible if the night set point is enabled (see section 4.10)

Clean mode set point

Select what is the target room temperature while the controller operates in clean mode.

Outside set point

The controller can adjust the moving speed of natural ventilation curtains as a function of outside temperature. When this function is used, the controller refers to the outside temperature set point to control the moving speed. Set the outside temperature to the desired value.

Accessible if the outside temperature sensor is enabled in section 4.7.1 and if the curtain compensation is enabled in the Installation Setup (section 4.5).

5.2 Temperature Curve

5.2.1 Principle of Operation

The controller can automatically adjust the target room temperature (day set point) over time by using a curve.

A curve is composed of 10 steps. Each step specifies a day number and a temperature set point for that day (the day number refers to the animal age). Once the curve is activated, the controller changes the set point every hour in a linear fashion between consecutive steps of the curve. When the last step is reached, the controller keeps using the temperature set point associated to that day.

Notes

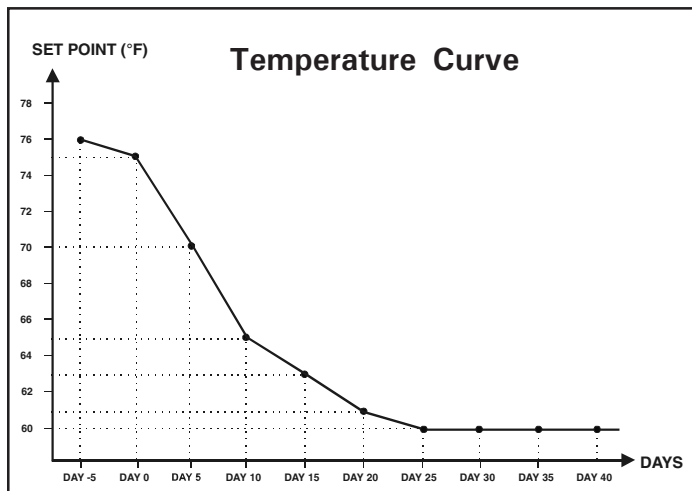

Certain restrictions apply to reduce the risk of errors:

- The highest possible day number is 450.
- Decreasing day numbers is not allowed.
- All ten steps must be specified. If you don't need ten different steps, repeat the last temperature for each unnecessary step.



5.2.2 Settings

Select:

-  Main menu
-  Set Point
-  Temp Curve*

* A password may be required to access this menu.

Cur. Day	Set Point
0 day	70.0 °F
day 1	78.0 °F
day 10	75.0 °F
day 15	70.0 °F
day 20	65.0 °F
day 25	63.0 °F
day 30	61.0 °F
day 35	60.0 °F
day 40	60.0 °F
day 45	60.0 °F
day 50	60.0 °F
Status	Off

Use ▼ to navigate



The following parameters can only be modified while the curve is off.

If the curve is running, it is still possible to adjust the set point value of all curve steps simultaneously with the curve offset parameter (see sec. 5.2.3).

- Set the following parameters:

Current day

This is the current age of the animals. This value may be changed to move backward or forward on the curve. A change in the current day also changes the animal age in the "Age & mortality" menu.

Set point

The day set point is displayed.

Day numbers

Set the day at which each step starts. The day number refers to the animal age. It is adjustable from -5 to 450 days. Negative values are used to prepare the house before letting the animals enter.

Can only be modified while the curve is disabled.

Temperature set points

Assign a temperature set point to each step of the curve.

Can only be modified while the curve is disabled or by using the curve offset function (sec. 6.1.3).

Status

Select "Yes" to activate the curve. Once the curve is on, the controller automatically adjusts the set point automatically between consecutive points of the curve; for this reason, curve steps cannot be modified while the curve is running.

5.2.3 Modifying Curve Points

You can adjust the temperature set point associated to all curve points while the curve is running.

Select:

- ★ Main menu
 - D Set Point
 - D Temp Curve
 - D Add/Subs Temp*
-

* Accessible while the curve is running only.

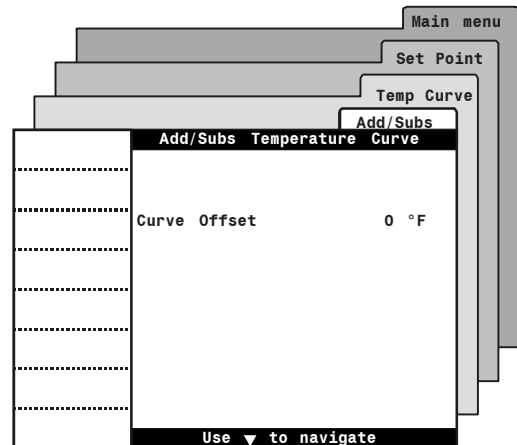

Temperature curve offset

Select the number of degrees that need to be removed or added to all set points of the temperature curve (+/- 10°F).

Accessible if the temperature curve is currently running.

6. VENTILATION & COOLING

6.1 Minimum Ventilation

6.1.1 Minimum Ventilation Cycles

Definition

Minimum ventilation cycles are activated when the average room temperature is below the start temperature of fan stage 1. Running the fans even though ventilation is not required for reducing the room temperature is useful to reduce humidity levels and supply oxygen to the room. It also prevents the fans from freezing in winter.

Minimum ventilation timer

The minimum ventilation timer is composed of an "On Time" and of a "Cycle Time". The fans stay on during the "On Time" then stop until the end of the cycle. This timer is common to all programs of the controller.

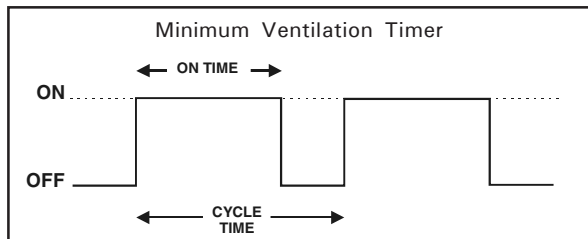

Minimum ventilation fans

If variable outputs are enabled, minimum ventilation cycles are ensured by the variable-speed fans of stage 1 and by chosen On/Off fans (optional). If variable outputs are not used, minimum ventilation is ensured by On/Off fans only. Refer to section 4.8.2 to assign these On/Off fans and refer to section 4.9 to assign variable fans to stage 1.

Automatic adjustment of the min. ventilation rate



The controller can automatically increase minimum ventilation rates over time: if variable fans are used, the controller can increase the minimum ventilation fan speed over time (curve function); if no variable fan is used, the controller can increase the "On Time" portion of minimum ventilation cycles (ramping function). Refer to the following sections to use the ramping or the curve function.

Night fan speed

If the nighttime minimum ventilation function is enabled (section 4.10), you can select another minimum ventilation fan speed which will be used at night.

Minimum Ventilation Settings

Select:

-  Main menu
-  Min. Vent.

- Set the following parameters:

Variable 1-2 minimum ventilation speed (regular & night speeds)

Specify the minimum ventilation speed of each variable fan; this is the speed of the fans during the "On Time" portion of minimum ventilation cycles. If night minimum ventilation is enabled in section 4.10, set the minimum speed separately for day and night.

Note that the minimum ventilation speed must be higher than the absolute minimum speed of the variable output (as defined in section 4.5).

Accessible if variable fans are assigned to stage 1. In addition, this parameter can only be modified while the speed curve is inactive (sec. 6.1.2.2).

Variable 1-2 status

Set the status of each variable output: select "On" if the output is used in minimum ventilation; select "Off" if it is not.

Accessible if variable fans are assigned to stage 1.

On Time & Cycle time of Var. outputs 1-2

Set the minimum ventilation timer separately for each variable output. The timer is composed of an "On time" and "Cycle time". Note that the "Cycle time" includes the "On Time", it must thus be longer than the "On time".

[This parameter is common to all programs].

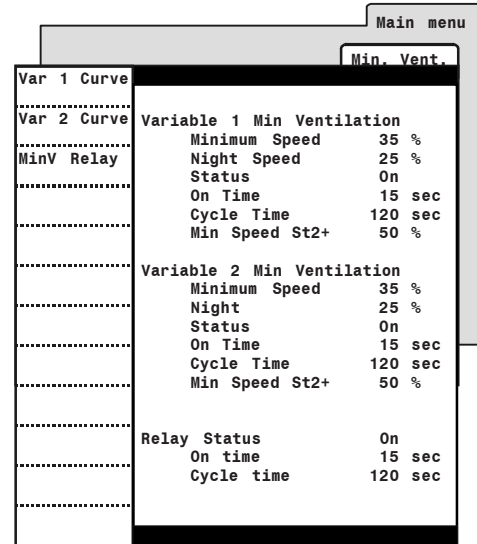

Min Speed Stage 2+ for Var. Outputs 1-2

Set the speed at which each variable output starts running at the beginning of stage 2 and beyond (see sec. 6.2).

Relay status

Set the relay status to "On" if some On/Off relays need to be activated during the "On Time" portion of minimum ventilation cycles. Refer to section 4.8.2 to assign On/Off fan relays.

Minimum ventilation timer

Set the timer that is used by the on/off fan outputs in minimum ventilation. The timer is composed of an "On time" and "Cycle time". Note that the "Cycle time" includes the "On Time", it must thus be longer than the "On time".

[This parameter is common to all programs].

6.1.2 Minimum Speed Curve

If variable outputs are assigned to stage 1, the controller can automatically adjust the minimum ventilation speed of these fans over time by using a curve.

A curve is composed of 10 steps. Each step specifies a day number and a minimum ventilation speed for that day (the day number refers to the animal age). Once the curve is activated, the controller changes the minimum ventilation speed every hour in a linear fashion between consecutive steps of the curve. When the last step is reached, the controller keeps using the speed associated to that day.

Notes

Certain restrictions apply to reduce the risk of errors:

- The highest possible day number is 450.
- Decreasing day numbers is not allowed.
- All ten steps must be specified. If you don't need 10 different steps, repeat the last speed for each unnecessary step.
- This curve must be set separately for each program.

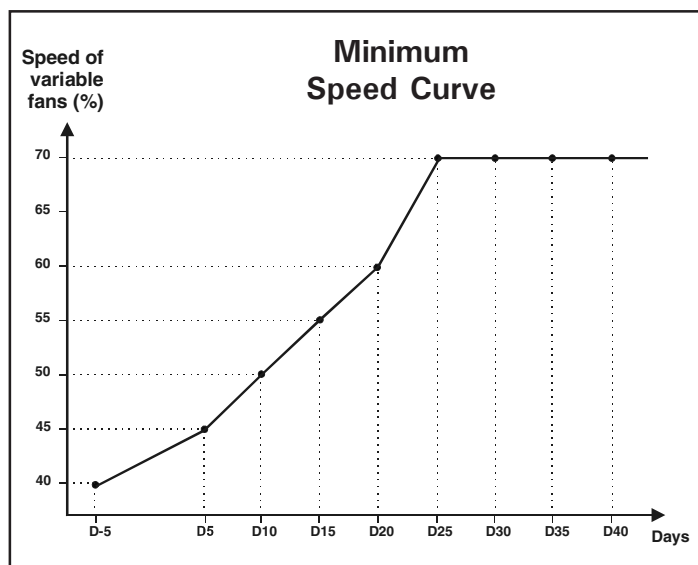

Curve Settings

Select:

- Main menu
- Min. Vent.
- Var 1 Curve or Var 2 Curve*

* A password may be required to access this menu (sec. 4.2).

Cur. Day	0 day
Min Speed	20 %
day 1	20 %
day 10	22 %
day 15	24 %
day 20	26 %
day 25	28 %
day 30	30 %
day 35	35 %
day 40	40 %
day 45	45 %
day 50	50 %
Status	Off

Use ▼ to navigate



The following parameters can only be modified while the curve is disabled.

If the curve is running, it is still possible to adjust the value of all curve steps simultaneously with the curve offset parameter (see section 6.1.3).

- Set the following parameters separately for each variable output in use: (Refer to the previous section to get further information on these parameters)

Current day

This is the current age of the animals. This value may be changed to move backward or forward on the curve. A change in the current day also changes the animal age in the "Age & mortality" menu.

Minimum Speed

The current minimum ventilation speed of the selected fan output is displayed.

Day numbers

Set the day at which each step starts. The day number refers to the animal age and it is adjustable from -5 to 450 days. Negative values are used to prepare the house before letting the animals enter.

Can only be modified while the curve is disabled.

Speed

Assign a fan speed to each step of the curve.

Can only be modified while the curve is disabled.





Status

Select "Yes" to activate the curve. Once the curve is on, the controller automatically adjusts the minimum ventilation speed automatically between consecutive points of the curve; for this reason, curve steps cannot be modified while the curve is running.

6.1.3 Modifying Curve Points

You can adjust the speed associated to all curve points while the curve is running.

Select:

-  Main menu
 -  Min. Vent.
 -  Var1 or Var 2 Curve
 -  Add/Subs Speed*
-

* Accessible while the curve is running only.

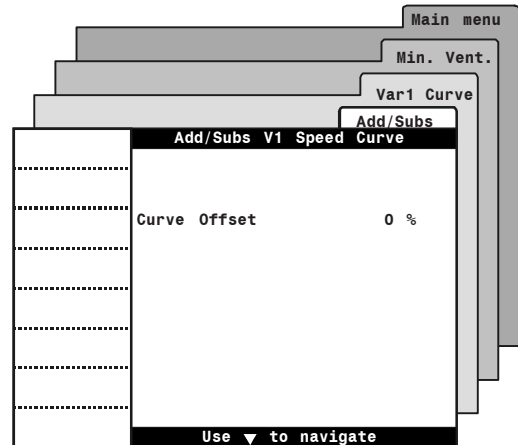

Var 1 & 2 min. speed curve offset

Select the speed that needs to be removed or added to all steps of the minimum speed curve (+/- 10%). Set this parameter separately for the curve of variable outputs 1 & 2.

Accessible if the minimum speed curve is currently running.

6.2 Fan Stages

6.2.1 Principle of Operation

6.2.1.1 Operation of Fan Stages

The controller has 12 fan stages which operate in a sequence to increase the level of ventilation as the room temperature increases. Each stage can activate two variable outputs, on/off outputs, and a combination of timer relays for cooling purposes. A fan stage is activated when the room temperature reaches its start temperature and is disabled when the room temperature decreases to its stop temperature.

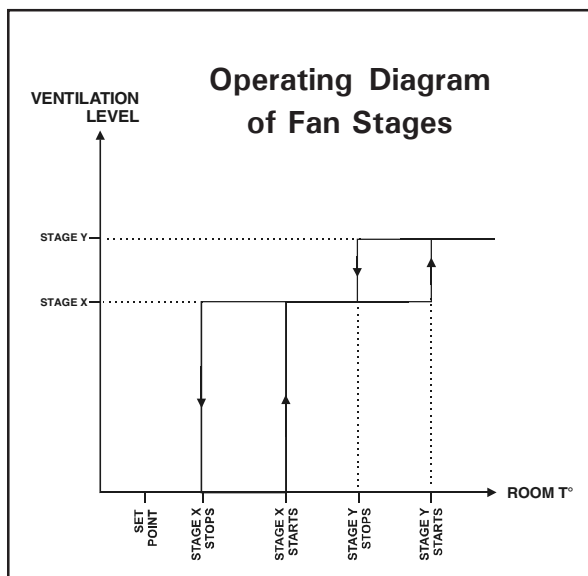

Start temperatures of fan stages are defined with respect to the set point and with respect to each other. This means that when one of these values is adjusted, all the consecutive values are adjusted by the same amount. For example, if the set point is increased by 1°F, the start temperature of all fan stages will be increased by the same amount.

Timer-based relays in fan stages

Fan stages can activate relays that operate following a timer (On and Off Times). This is useful to activate misting units in timer mode while a specific fan stage is active. Refer to section 4.8 to enable timer-based relays.

6.2.1.2 Operation of Variable Outputs

Variable outputs are activated when their associated fan stage starts (see section 4.9). They start running at their absolute minimum speed (see section 4.5) and their speed gradually increases as the room temperature increases. Variable outputs reach their full speed when the start temperature of the following fan stage is reached.

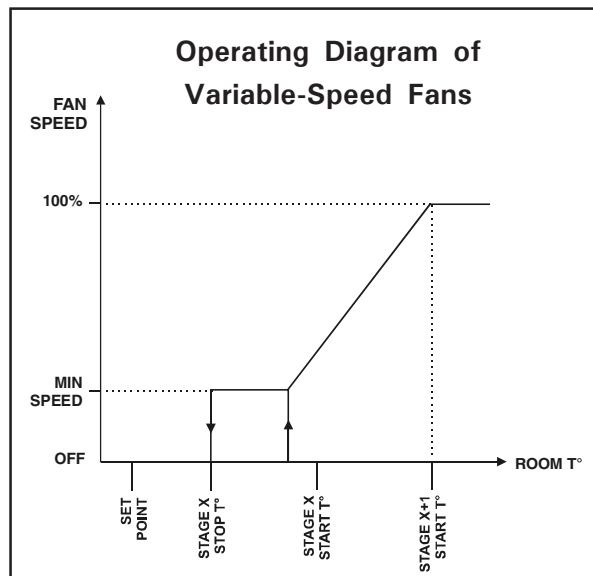

EXPERT SERIES 2 BASIC

Transition between fan stages 1 and 2

If the next stage is an on/off fan stage, variable outputs are disabled at the beginning of this on/off stage; if the next stage is another variable-speed stage, the speed of variable outputs is reduced the

minimum speed associated with stage 2 (min speed stage 2+). This ensures a smooth transition between both stages. Refer to section 6.1.1 to set the initial speed of both variable outputs for stages 1 and 2.

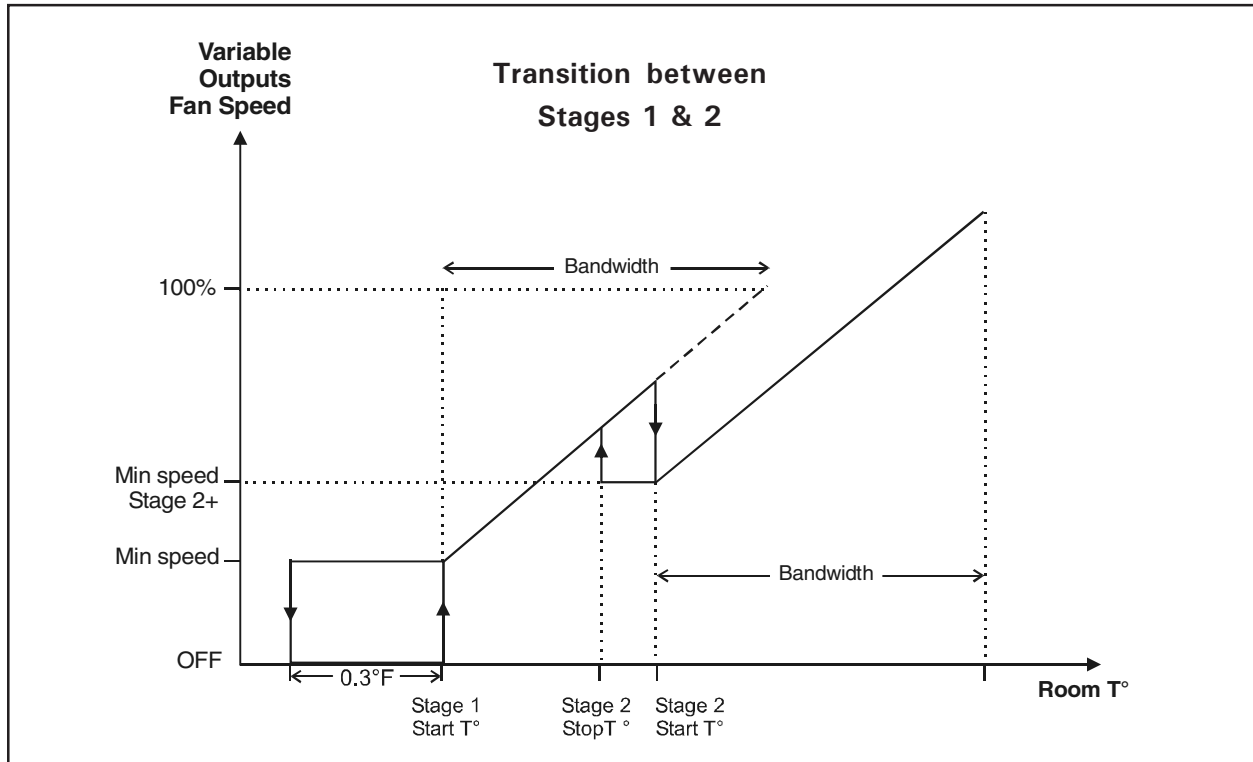

The **bandwidth** is the temperature interval over which variable outputs go from their minimum to their maximum speed. This is true even if full speed is never reached as in the example above: when stage 2 starts, the controller decreases the speed of variable outputs to the initial speed associated with stage 2. It then uses the bandwidth to increase the fan speed as the room temperature rises.

EXPERT SERIES 2 BASIC

6.2.1.3 Stage 1 Ramping

The controller can gradually increase (or decrease) the running time of the fans to smooth out the transition from the minimum ventilation cycle to full operation of stage 1 fans.

At room temperatures at or below the set point, the controller operates the fans of stage 1 according to the minimum ventilation cycle.

If the room temperature rises above the set point, a new On Time is calculated periodically as the temperature increases to allow a smooth progression

(from point A to point B) up to full operation of the fans when the set point + differential 1 is reached (when Time Off becomes less than 15 seconds, it is fixed at 15 seconds until the temperature has reached the set point + differential 1. At that point, the fans of stage 1 operate continuously).

If the room temperature decreases 0.3°F below the set point + differential 1, the On Time value of the minimum ventilation cycle decreases gradually from a value equal to the total cycle time (point C) towards the regular On Time.

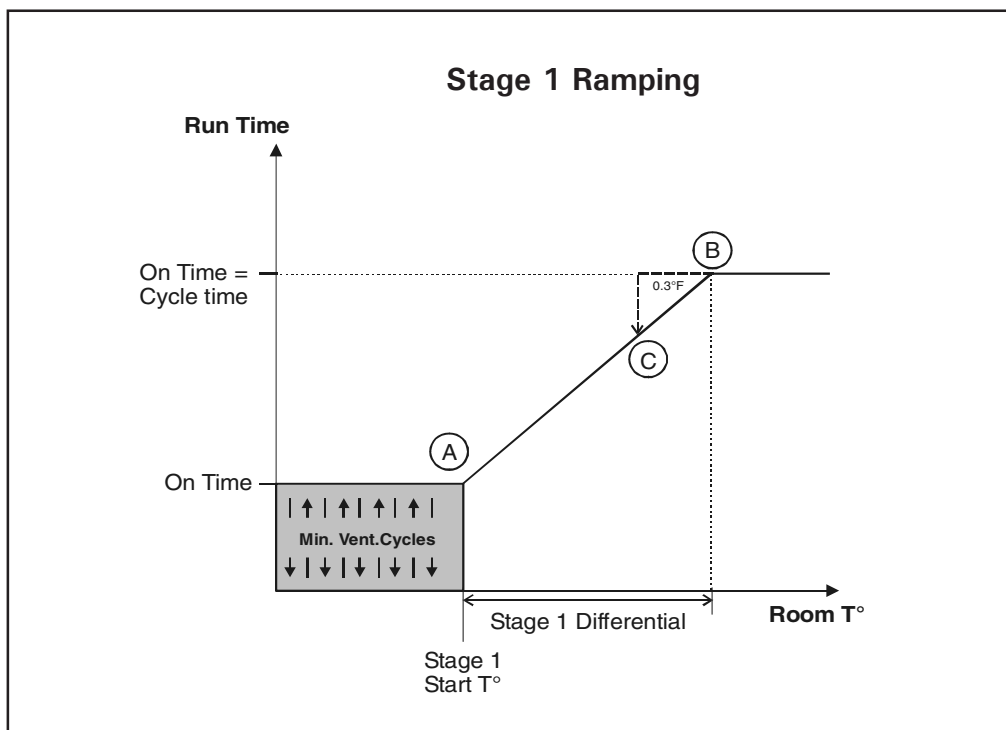



Ramping Settings

To use the ramping function, disable variable outputs in the Installation Setup (section 4.5) and adjust the differential of stage 1 in section 6.2.2.

EXPERT SERIES 2 BASIC

6.2.2 Fan Stage Settings

Select:

-  Main menu
-  Start/Stop*
-  Fan Stages

* A password may be required to access this menu (sec. 4.2).

- Set the following parameters:
(Refer to the previous section to get further information on these parameters)

Start & Stop temperatures

Set the start and stop temperatures of each fan stage.

Notes:

Stage 1 stops when the room temperature falls 0.3 °F below its start temperature.

The minimum difference between two consecutive start temperatures is of 0.5 °F (0.3 °C).

The start temperature of a fan stage must be greater value than its stop temperature.

V1 & V2 Bdw (Bandwidth)

The bandwidth is the temperature interval over which variable outputs go from their minimum to their maximum speed. Set the bandwidth of each variable output in use.

Accessible if variable outputs are assigned to fan stages (section 4.9).

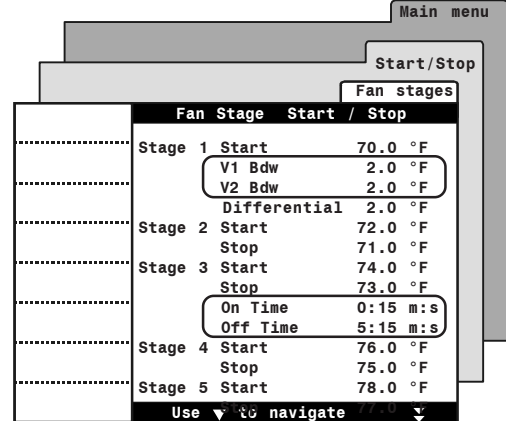

The screenshot shows a menu titled 'Fan stages' with a table of settings for five stages. The table has columns for 'Fan Stage', 'Start / Stop', and values. Stage 1 includes 'V1 Bdw' and 'V2 Bdw' settings. Stage 3 includes 'On Time' and 'Off Time' settings. The bottom of the screen shows a navigation prompt: 'Use [arrow keys] to navigate'.

Fan Stage	Start / Stop	Value
Stage 1	Start	70.0 °F
	V1 Bdw	2.0 °F
	V2 Bdw	2.0 °F
	Differential	2.0 °F
Stage 2	Start	72.0 °F
	Stop	71.0 °F
Stage 3	Start	74.0 °F
	Stop	73.0 °F
	On Time	0:15 m:s
	Off Time	5:15 m:s
Stage 4	Start	76.0 °F
	Stop	75.0 °F
Stage 5	Start	78.0 °F

Differential

The differential is the temperature difference between the moment the Stage 1 start running in timer mode (stage 1 ramping) and the moment they run continuously. Refer to the diagram in section 6.2.1.3 The differential can be adjusted between 0.5°F and 20.0°F (0.3°C and 11.1°C).

Accessible if the ramping option is enabled (i.e. if variable outputs are disabled in the Installation Setup (section 4.5)).

Timer

If timer-based relays are assigned to some fan stages (sec. 4.8), set the On Time and the Off Time of each timer-based relay. On and Off Times can be adjusted from 0 to 99 minutes in increments of 15 seconds.

EXPERT SERIES 2 BASIC

6.2.3 0-10V Ventilation Outputs

The controller has two 0-10V outputs that can either be used to control heat lamps, heat mats, inlets or fans. To operate these outputs, the controller refers to the average temperature reading of their assigned temperature probes (see sec. 4.7.3).

This section explains how 0-10V ventilation outputs work.

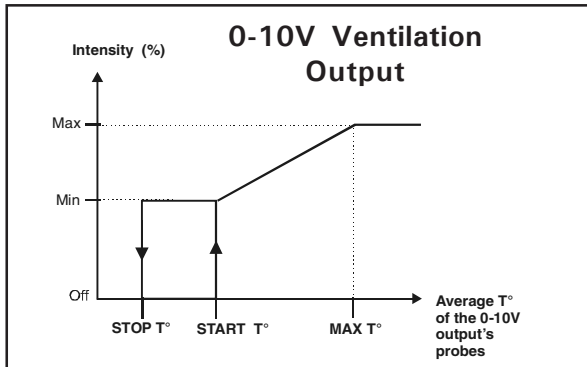

0-10V ventilation outputs start at their minimum intensity when the average temperature of their probes reaches the start temperature. They increase in intensity as the temperature increases; 0-10V outputs reach their maximum intensity when the temperature rises to the Maximum Temperature parameter setting.

0-10V Mode: Automatic / Manual

You can manually control the intensity of a 0-10V output by using the manual control mode. While this mode is used, the controller stops controlling the output and lets you choose the intensity of the output.

Main menu	
Start/Stop	
0-10V	
0-10V #X	
0-10V Output #X Ventilation	
Mode	Automatic
Current Output	100 %
Start Temperature	70.0 °F
Minimum	40
Maximum	100
Max Output at	72.0 °F
Stop at	69.5 °F

Settings

Select:

- Main menu
- Start/Stop*
- 0-10V**
- Select a 0-10V **Ventilation** output**

* A password may be required to access this menu.

** Accessible if a 0-10V ventilation output is enabled in the Installation Setup (section 4.5).

- Set the following parameters:

Mode: Set the operating mode of the 0-10V output: select "Automatic" if you want the controller to control the output or select "Manual" to specify the intensity of the output yourself.

Current output: This is the current intensity of the output. This intensity can be modified while the manual mode is enabled above.

Start temperature: Set the start temperature to the desired value. This temperature can be set as a fix value (absolute) or it can be related to the set point: this means that when the set point changes, the start temperature is adjusted by the same amount. (refer to section 4.5 to specify if the start temperature of the 0-10V follows the set point or not).

Minimum & max speeds: Set the minimum and maximum speeds of the 0-10V output. The maximum speed must be greater than the minimum speed.

Maximum output at: Set the temperature at which the output reaches its maximum speed (this parameter must be set to a greater value than the start temperature).

Stop at: This is the temperature below which the 0-10V output stops.

6.3 Natural Ventilation Curtains

The controller can control two natural ventilation curtains. To operate these curtains, the controller refers to the average temperature reading of their assigned temperature probes (see sec. 4.7.3).

6.3.1 Principle of Operation

The controller enters in natural ventilation when the average temperature of the probes that are assigned to a curtain reaches the *Initial Opening Temperature* of the curtain. At that moment, the curtain opens during its *Initial Opening Time*.

When the natural ventilation mode is on, the natural ventilation curtain moves in timer mode: it opens according to its opening cycle (*Open Time & Off Time*) when the average temperature rises above its opening temperature; likewise, it closes according to its closing cycle (*Close Time & Off Time*) when the temperature falls below its closing temperature.

Natural ventilation is disabled when the average temperature decreases of 5°F (2.8°C) below the curtain's closing temperature or when tunnel ventilation starts (see graph below).

Transition from tunnel to natural ventilation

When the temperature decreases below the start temperature of the first tunnel stage, the controller opens the curtain continuously during the *Continuous Opening Delay*. When this delay has elapsed, it starts controlling the curtain using natural ventilation settings.



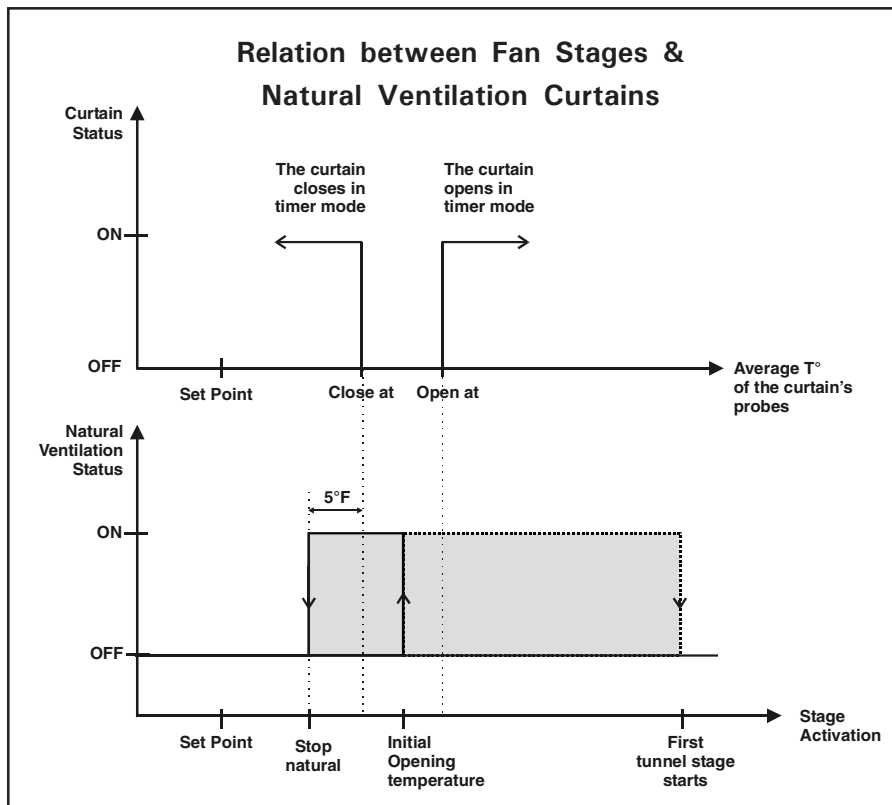

Transition from natural to tunnel ventilation

When the natural ventilation curtain is opened and the room temperature reaches the start temperature of the first tunnel stage, the controller waits for the *Tunnel Close Delay* then fully closes the natural ventilation curtain.



6.3.2 Natural Ventilation Settings

Select:

-  Main menu
-  Start/Stop*
-  Natural**
-  Curtain #X

* A password may be required to access this menu (sec. 4.2).

** Accessible if at least 1 natural ventilation curtain is enabled in the Installation Setup (section 4.5).

- Set the following parameters:
(Refer to previous sections to get further information on these parameters)

Initial Open at

Set the temperature at which the curtain opens for the first time. The curtain opens during its initial moving time at that moment.

Note that the initial temperature of natural ventilation is limited by the start temperature of the last fan stage that belongs to the lateral ventilation mode (power mode).

Start Close at

Set the temperature below which the curtain starts closing in timer mode when the controller is in natural ventilation.

Start Open at

Set the temperature above which the curtain opens according to a timer when the controller is in natural ventilation.

Initial Time

The curtain opens during its initial opening time when the controller enters in natural ventilation. This opening time can be adjusted from 0 to 900 seconds (15 minutes).

Open / Close / Off Time

Set the opening and closing timers of the curtain (the Off time is common to both cycles). The open, close and off times can be adjusted from 0 to 900 seconds (15 minutes).

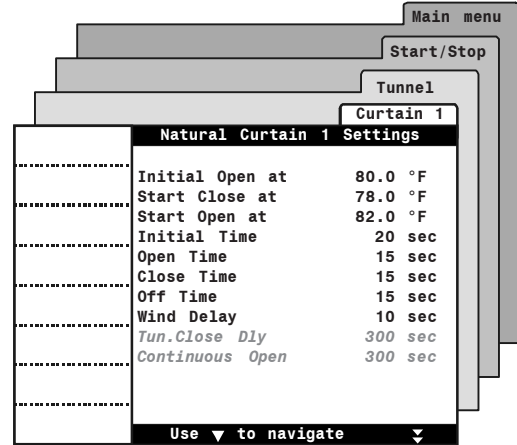

Wind Delay When the controller is in natural ventilation and temperature falls below the "Start Close At" temperature or rises above the "Start Open At" temperature, the curtain only starts moving after the wind delay has elapsed. This way, the curtain does not move when wind drafts cause sudden temperature changes. Set the wind delay to the desired value. Adjustable from 0 to 900 seconds (15 minutes).

Tunnel Close Delay (Factory Setting)

This delay is launched at the beginning of the first tunnel stage. Once it has elapsed, the controller closes the natural ventilation curtain.

Continuous Delay (Factory Setting)

The natural ventilation curtain opens during this delay when the controller returns in natural ventilation (when tunnel ventilation ends).

6.3.3 Curtain Compensation

The controller can slightly adjust opening of the curtains as a function of outside temperature: as the outside temperature increases, the controller increases the opening time of the curtains. As a result, curtains open faster when the outside temperature gets warm. Likewise, when the outside temperature gets cold the controller increases the closing time of the curtains. This compensation is optional. To use it, enable the curtain compensation in the Installation Setup (section 4.5). Then, set the outside temperature set point (section 5.1).

When temperature rises:

When the curtain opens, the controller increases the curtain's On Time by 4% for every 1°F (0.6°C) in the compensation interval (i.e. an interval of 3°F means a 12% increase). The curtain's Off Time is decreased by the same amount.

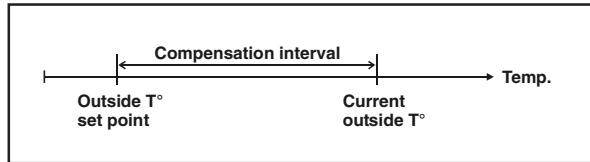

When temperature falls:

When the curtain closes, the controller increases the curtain's On Time by 4% for every 1°F (0.6°C) in the compensation interval (i.e. an interval of 3°F means a 12% increase). The curtain's Off Time is decreased by the same amount.

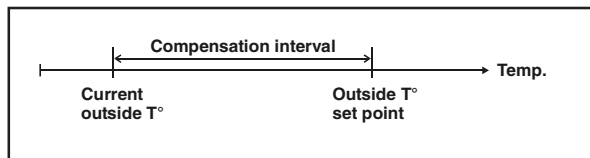

6.3.4 Stopping Fans in Natural Vent.

Whisker switches are used to stop some on/off and variable-speed fan outputs when the controller is in natural ventilation. These switches tell when the curtains are sufficiently opened.

When temperature rises (point A on the graphic):

The controller gradually opens the curtain as temperature rises. It can also disable a chosen selection of fans when the curtain is sufficiently opened (when the curtain has reached its whisker switch).

When temperature falls (point B on the graphic):

At point B, the curtain is already opened and the fans are stopped. The controller gradually closes the curtain as temperature falls. The controller restarts the fans when the curtain closes and releases its whisker switch.

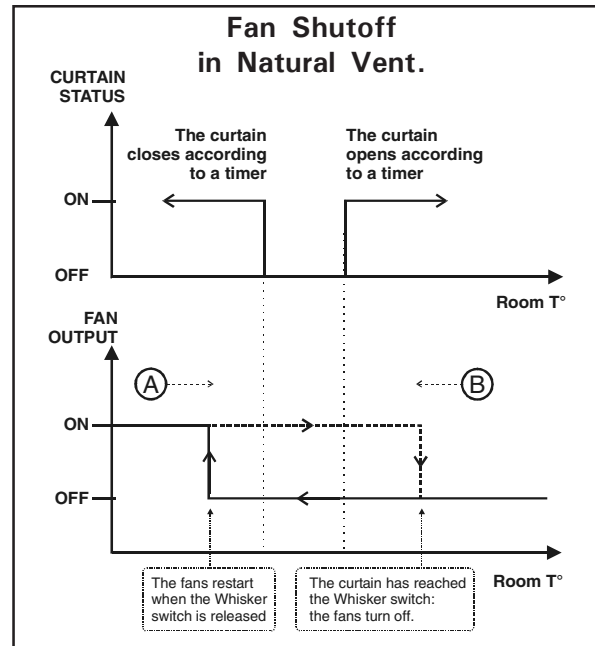

Security: If the temperature drops suddenly or if the whisker switch is defective, the controller automatically restarts the fans when the temperature falls 5°F (3°C) below the lowest curtain's closing temperature. When this situation occurs, a defective whisker switch alarm is posted to the alarm log.



Refer to section 4.8 to select what fan relays must turn off in natural ventilation.

6.4 Tunnel Doors

The controller can control 2 tunnel doors. It opens these doors gradually as the room temperature increases.

Beginning of tunnel ventilation

The activation of tunnel ventilation is linked with the activation of a user-defined fan stage: when the start temperature of that chosen fan stage is reached, the tunnel door opens during the opening time associated with that stage. The activation of every consecutive fan stages causes the tunnel door to open further. The stage at which the tunnel door fully opens is also defined by the user.

Minimum age

A minimum age can be specified to avoid entering in tunnel ventilation when the animals are too young. This feature is optional and can only be used if age-based functions are enabled in the Installation Setup (section 4.5).

Minimum outside temperature

A minimum outside temperature can be specified to avoid entering in tunnel ventilation when it is too cold outside. This feature is optional and can only be used if an outside temperature probe is enabled (sec. 4.7.1).

Opening times

The user must associate an opening of the tunnel door to each tunnel fan stage. When a tunnel fan stage starts, tunnel doors open according to the opening time associated to that stage. Opening times are set separately for each tunnel door.

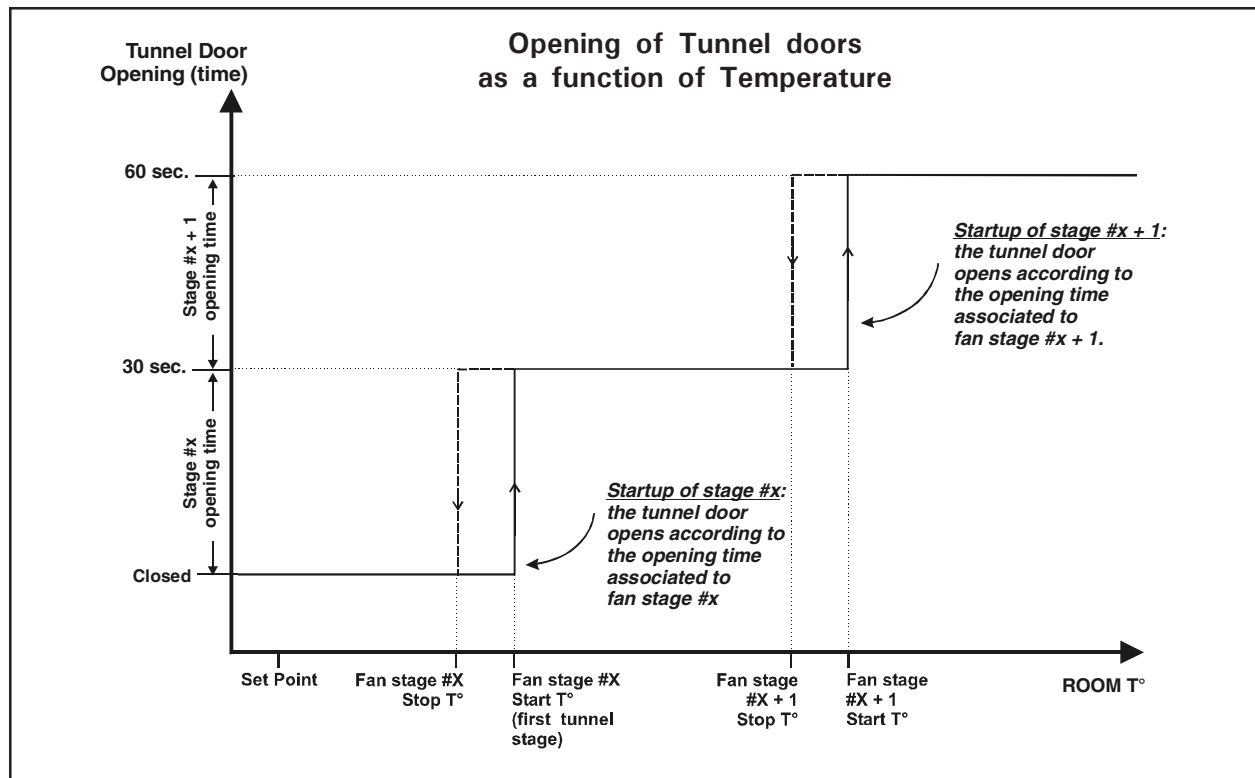

Reference temperature in tunnel ventilation

The selection of probes that is used to measure the room temperature can be changed in tunnel ventilation to compensate for changes in airflow patterns that can distort the room temperature calculation. The user must select at what fan stage the second probe set starts being used.



Tunnel door Settings

Select:

-  Main menu
-  Start/Stop*
-  Tunnel**

* A password may be required to access this menu.
 ** Accessible if at least one tunnel door is enabled in the Installation Setup (section 4.5)

- Set the following parameters:
 (Refer to the previous section to get further information on these parameters)

First stage

Both tunnel doors start opening when the start temperature of this fan stage is reached. Select what fan stage signals the beginning of tunnel ventilation.

100 % opened

Both tunnel doors fully open when the selected fan stage starts. Select the fan stage at which tunnel doors are totally opened.

Probe set 2 starts at stage

Select at what fan stage the controller starts measuring the room temperature with the second probe set.

Minimum age

Select the animal age below which both tunnel doors remain closed. Adjustable from 1 to 450 days or select "Off" to disable this function.

Available if age-based functions are enabled in the Installation Setup (section 4.5).

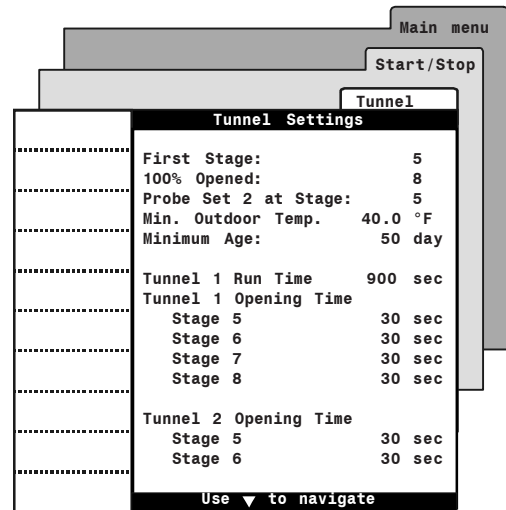

Minimum outdoor temperature

Select the outside below which both tunnel doors remain closed or select "Off" to disable this function.

Available if an outside temperature probe is enabled (section 4.7.1).

Tunnel run time

Specify the amount of time required to fully open the tunnel curtain's actuator. The sum of all opening times will be limited by this value.

Opening times

Assign a tunnel door opening time with the start-up of every tunnel fan stage. If two tunnel doors are used, assign these opening times separately for each tunnel door. Opening times can be adjusted from 0 to 900 seconds (15 minutes).

The sum of all opening times cannot exceed the "Tunnel run time" parameter value.

6.5 Timer-based Air Inlets

The controller can control the opening of two air inlets. It can either control the first inlet in timer mode or with a potentiometer; the second air inlet can only operate in timer mode. Set the operating mode of the first air inlet in the Installation Setup (section 4.5).

6.5.1 Principle of Operation

When timer-based inlets are used, the user must first specify the total time that is required to fully open each inlet. Then, the user must associate an inlet opening with the start-up of each fan stage (inlet openings are defined as a percentage of the total opening time). As the room temperature increases and new stages are activated, air inlets will open or close accordingly.

Inlet opening in minimum ventilation

The inlet is at its "Closed" position during the Off Time portion of a minimum ventilation cycle and opens to its minimum ventilation position during the On Time.

Over-opening of air inlets

A supplementary stage can be defined in order to continue opening air inlets beyond the activation temperature of the last ventilation stage. This over-opening stage is used to direct the airflow more efficiently during periods of warm weather. When all reference points of ventilation stages are defined, the user can specify the temperature at which air inlets reach their over-opening position (Start T° of the last stage + over-opening bandwidth).

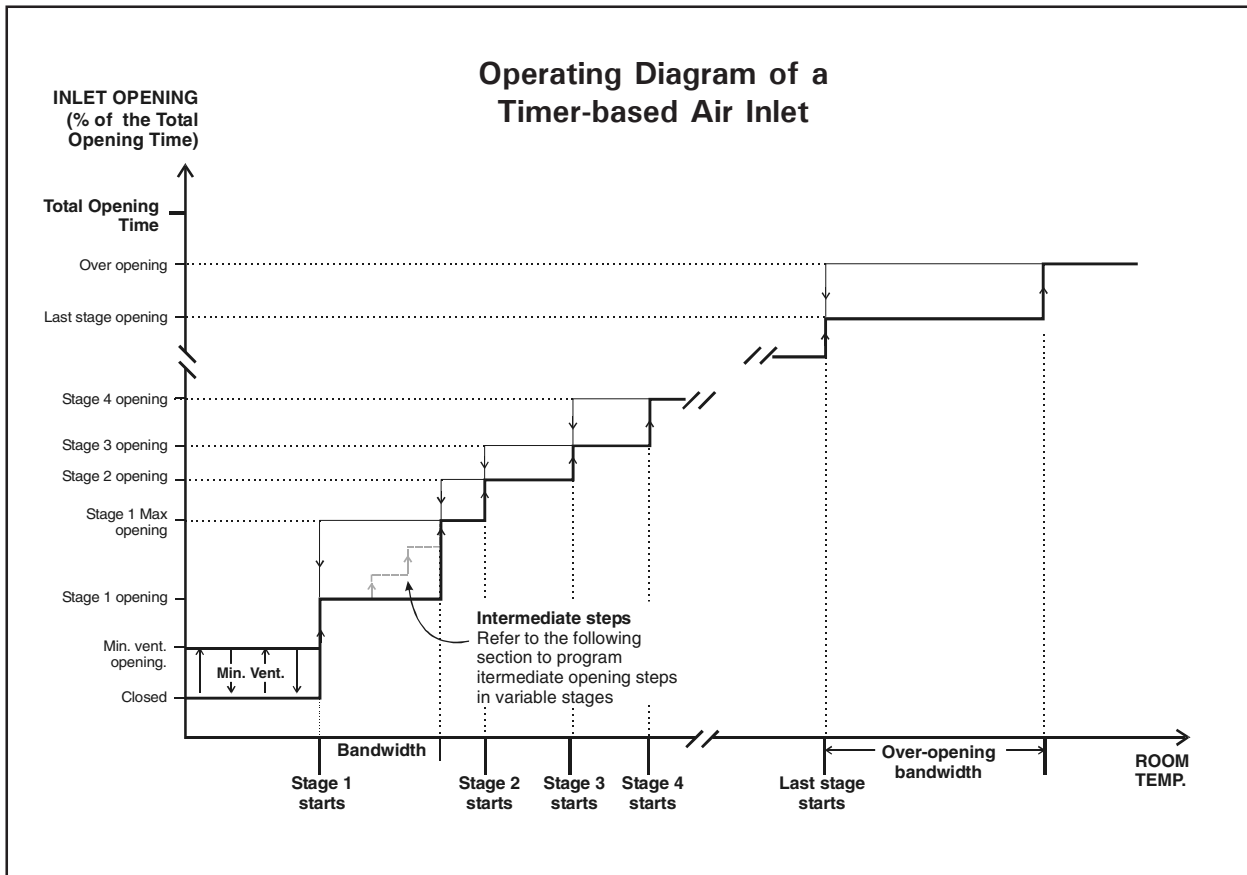

Opening of the inlets in a variable-speed fan stage

When variable-speed fan stages are used, the user must associate an inlet opening with the beginning and with the end of each variable stage. Once this is done, it is possible to subdivide this opening into 0 to 2 intermediate opening steps to progressively open the inlet during the stage.

When intermediate opening steps are used, the controller splits up the inlet opening of the variable stage evenly between the number of intermediate steps (e.g., if one intermediate step is enabled, the controller will open the inlet twice during the variable stage (50% of the stage opening at the first intermediary step, 50 % at the end of the stage)).

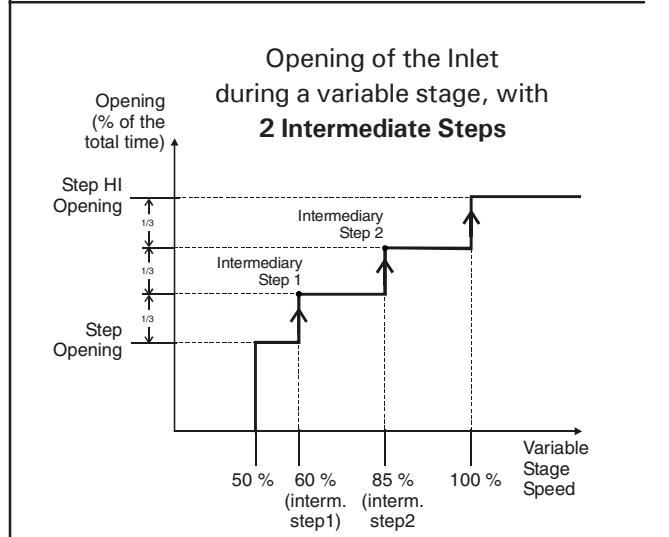
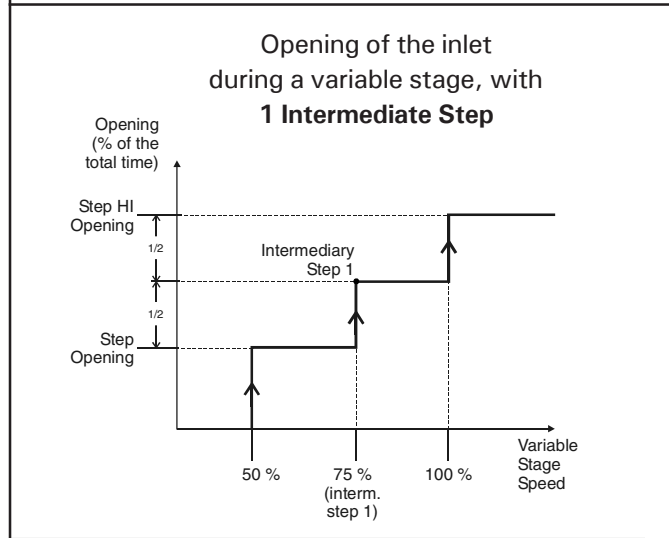
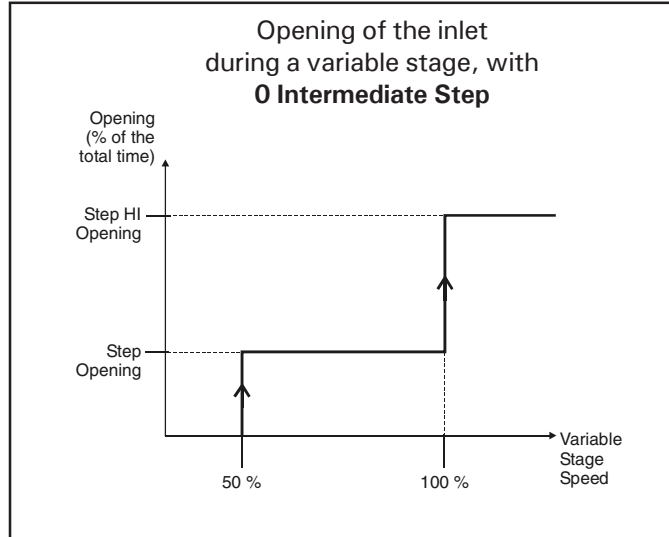

Inlets open to their intermediate positions when the variable stage reaches predefined fan speeds. These fan speeds are set differently depending on the number of intermediate steps in use. For instance, if 1 intermediate step is enabled, the inlet opens during half of the variable stage's opening when the stage's speed is of 75 %; it reaches the stage's HI opening position when the fan stage reaches 100 %.

The three following graphs illustrate when each intermediate step starts as a function of the number of intermediate steps.



6.5.2 Timer-based Inlet Settings

Select:

-  Main menu
-  Inlets*
-  Inlet 1 is already displayed; press Inlet 2 to display parameter settings of Inlet 2.

* Accessible if at least one inlet is enabled in the Installation Setup (section 4.5). A password may also be required to access this menu (section 4.2).



Make sure you have selected a timer-based air inlet. Refer to section 4.5 to set the inlet mode.



Inlet openings are defined as a percentage of their total opening time.

Position: This is the current position of the selected air inlet. This value cannot be modified.

Test mode: This is the room temperature that is used in test mode. This value can only be modified in the "Test Mode" menu (see section 4.12).

Closed: This is the position of the air inlet during the Off Time portion of minimum ventilation cycles. Set this position to the desired value.

Min Vent: This is the position of the air inlet during the On Time portion of a minimum ventilation cycle.

Stage #x: Assign an inlet opening (in %) with the startup of each fan stage.

Stage #x max: Assign the inlet opening that is reached when the variable-speed fan stage reaches its maximum intensity.

Inlet 1 Settings	
Inlet 2	Position 0 %
Auto Reset	Test Mode 72.3 °F
Openings	
	Closed 0 %
	Min. Vent. 5 %
	Stage 1 10 %
	Stage 1 Max 15 %
	Stage 2 20 %
	Stage 3 30 %
	Stage 4 40 %
	Stage 5 50 %
	Stage 6 60 %
	Stage 7 70 %
	Stage 8 80 %
Over Opening settings	
	Opening 100 %
	Bandwidth 5.0 °F
	Total Opening Time 2:00 m:s
	#Step on var. stage 1
Use ▼ to navigate ▼	

Over-Opening Settings:

Opening

Assign an inlet position to the over-opening stage.

Bandwidth

Set the temperature range over which the inlet gradually opens from the position associated with the last fan stage towards the over-opening position (see previous graphic).

Total opening time

Enter the **exact time** that is required to reach the actuator's maximum limit switch. The controller will limit the opening of the inlet according to this parameter value.

* Accessible if at least one timer-based inlet is enabled in the Installation Setup (section 4.5). [This parameter is common to all programs].

of opening steps in variable stages

Set the number of intermediary steps that are used to open the inlet in the course of a variable-speed fan stage.

* Accessible if at least one timer-based inlet is enabled and if variable outputs are enabled in the Installation Setup (section 4.5). [This parameter is common to all programs].

6.5.3 Resetting the Actuator's Position

Resetting the actuator's position is used to clear accumulated time offsets caused by the frequent openings and closings of the inlet. The controller resets the actuator's position at regular intervals to make sure the inlet position is always accurate. This reset is performed automatically according to one of these two methods:

- **Reset the minimum position only**
(Close mode)

Each time a reset is performed, the inlet totally closes. Once the actuator's position is reset, the inlet returns to its previous position. The "Close" pilot light of the inlet flashes while the controller closes the inlet.



- **Reset toward the nearest position**
(Open/Close mode)

If the current inlet position is higher than 50% at the reset time, the controller fully opens the inlet to reset the actuator's position; if the current inlet position is lower than 50%, the controller closes the inlet to perform the reset. This way, the inlet never closes when the room temperature already asks for a wide opening. The "Open" or "Close" pilot light of the inlet flashes while the controller moves the inlet.



Make sure limit switches are located at both ends of the actuators when using this resetting method.

Select:

-  Main menu
-  Inlets*
-  Auto-Reset*

* Accessible if at least one *timer-based* inlet is enabled in the Installation Setup (section 4.5). In addition, a password may be required to access this menu.



[The following parameters are common to all programs].

Main menu	
Inlets	
Auto Reset	
Auto Reset Settings	
Inlet Reset Mode	Op/Cl
Inlet Reset Now?	No
Day Time	6:00A h:m
Period	3 day
Reset Delay	2:00 m:s

Inlet reset mode:

Select the desired reset mode: "Op/Cl" to reset the actuator toward its nearest position; select "Close" to reset the actuator toward its closed position only or select "Off" to disable the automatic reset.

Inlet reset now? Select "Yes" to reset the actuator's position now.

Day time:

Set the time at which resets are performed.

Period:

Enter the frequency of inlet resets. A reset can be performed once every 1-7 days.

Reset delay:

During a reset, the controller opens or closes the inlet during this delay, or up until a limit switch is reached. The reset delay should be set to the same time value or higher than the total opening time (as defined in section 6.5.2).

6.6 Air Inlets with Potentiometer

The controller can control the opening of two air inlets. It can either control the first inlet in timer mode or with a potentiometer; the second air inlet can only operate in timer mode. Set the operating mode of the first air inlet in the Installation Setup (section 4.5).

6.6.1 Principle of Operation

When potentiometer-based inlets are used, the user associate an inlet opening with the start-up of each fan stage. As the room temperature increases and new stages are activated, air inlets will open or close accordingly.

Inlet opening in minimum ventilation

The inlet is at its "Closed" position during the Off Time portion of a minimum ventilation cycle and opens to its minimum ventilation position during the On Time.

Over-opening of the air inlet

A supplementary stage can be programmed in order to continue opening the air inlet beyond the activation temperature of the last ventilation stage. This over-opening stage is used to direct the airflow more efficiently during periods of warm weather. When all reference points of ventilation stages are defined, the user can specify the temperature at which the air inlet reaches its over-opening position (Start T° of the last stage + over-opening bandwidth).



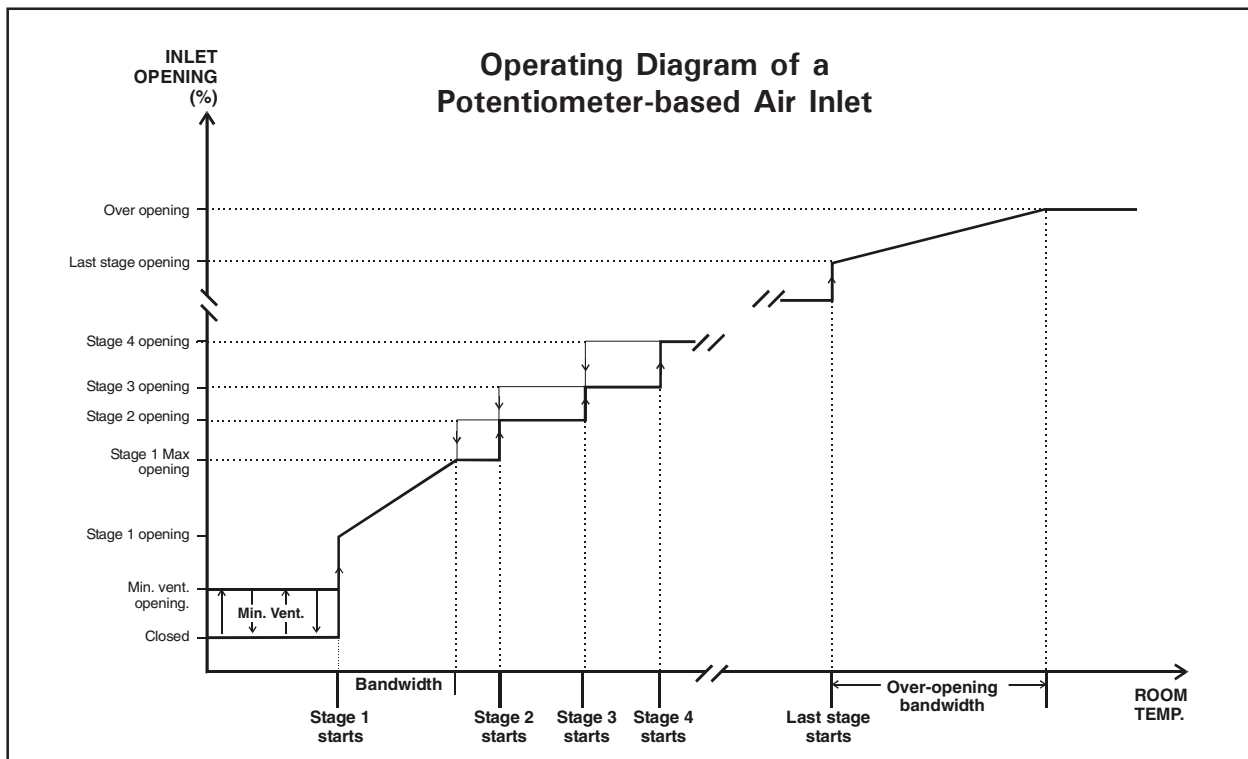

Security function

If the potentiometer is defective, the controller will operate in security mode: if the room temperature is 2°F (1.1°C) above the set point, the inlet opens according to the following cycle: 8 seconds ON, 60 seconds OFF. If the room temperature is 2°F (1.1°C) below the set point, the inlet closes according to the same cycle.



6.6.2 Potentiometer Inlet Settings

Select:

-  Main menu
 -  Inlets*
- Inlet 1 is already displayed.

* Accessible if at least one inlet is enabled in the Installation Setup (section 4.5). In addition, a password may be required to access this menu (section 4.2).



Make sure inlet 1 uses a potentiometer. Refer to section 4.5 to set the inlet mode (inlet 2 cannot use a potentiometer).

- Set the following parameters:
(Refer to the previous section to get further information on these parameters)

Position

This is the current position of the selected air inlet. This value cannot be modified.

Test mode

This is the room temperature that is used in test mode. This value can only be modified in the "Test Mode" menu (see section 4.12).

Closed

This is the position of the air inlet during the Off Time portion of minimum ventilation cycles. Set this position to the desired value.

Min Vent

This is the position of the air inlet during the On Time portion of a minimum ventilation cycle.

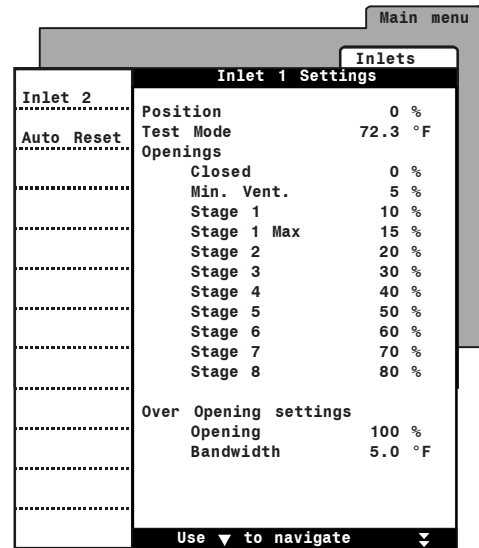

Stage #x

Assign an inlet opening (in %) with the startup of each fan stage.

Stage #x max

Assign the inlet opening that is reached when the variable-speed fan stage reaches its maximum intensity.

Over-Opening Settings:

Opening

Assign an inlet position to the over-opening stage.

Bandwidth

Set the temperature range over which the inlet gradually opens from the position associated with the last fan stage towards the over-opening position (see previous graphic).



6.6.3 Inlet Calibration

If inlet 1 uses a potentiometer, the actuator of the inlet must be calibrated. This calibration tells the controller what are the minimum and maximum positions of the actuator:

Minimum calibrated position = opening of 0%

Maximum calibrated position = opening of 100%

Select:

-  Main menu
-  Inlets*
-  Calib**

* Accessible if at least one inlet is enabled in the Installation Setup (section 4.5). In addition, a password may be required to access this menu.

** Accessible if inlet 1 uses a potentiometer (section 4.5).

- Set the following parameters:
(Refer to the previous section to get further information on these parameters)

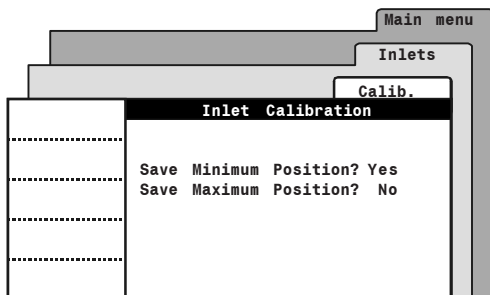

Save minimum position?

To calibrate the minimum position, use the "Close" switch to close the inlet to its minimum position. Once the inlet is closed, set the manual control switch to "Off" to stop the actuator.

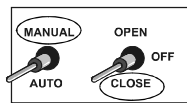

Now that the actuator is closed, answer "Yes" to the "Save minimum position?" question on screen. Once the "Yes" answer is posted, the controller switches the answer back to "No"; the minimum position is now saved.

Save maximum position?

To calibrate the maximum position, use the "Open" manual control switch to fully open the inlet. Once the maximum inlet opening is reached, set the manual control switch to "Off" to stop the actuator.

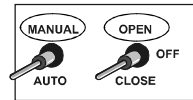

Now that the actuator is opened, answer "Yes" to the "Save maximum position?" question on screen. Once the "Yes" answer is posted, the controller switches the answer back to "No"; the maximum position is now saved.

- Once the calibration is completed, set the manual control switch back to the "Auto" position to enable the automatic control of the inlet.

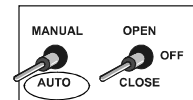

For best results, make sure at least 12 inches (30 cm) separates the minimum actuator's position from its maximum position.

6.7 0-10V Air Inlets

The controller has two 0-10V outputs that can either be used to control heat lamps, heat mats, inlets or fans. To operate these outputs, the controller refers to the average temperature reading of their assigned temperature probes (see sec. 4.7.3). This section shows how a 0-10V inlet output works.





A 0-10V air inlet works exactly the same as a potentiometer-based air inlet but does not need to be calibrated.

0-10V Mode: Automatic / Manual

You can manually control the opening of a 0-10V output by using the manual control mode. While this mode is used, the controller stops controlling the output and lets you choose the inlet opening.

Settings

Select:

-  Main menu
-  Start/Stop*
-  0-10V**
-  Select a 0-10V Air Inlet output**

* A password may be required to access this menu.

** Accessible if a 0-10V inlet output is enabled in the Installation Setup (section 4.5).

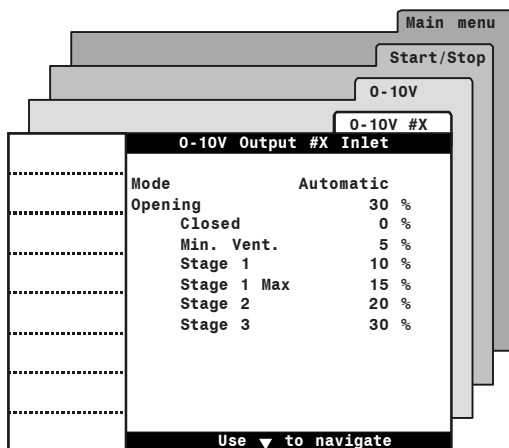

- Set the following parameters:



0-10V inlets work as potentiometer-based inlets. Refer to section 6.6.1 to see how they work and to get information about the following parameters.

Mode: Set the operating mode of the 0-10V output: select "Automatic" if you want the controller to control the output according to specified parameter settings below or select "Manual" to specify the inlet opening manually.

Opening: This is the current opening of the air inlet. This opening can be changed when the manual mode is enabled above.

Closed: This is the position of the air inlet during the Off Time portion of minimum ventilation cycles. Set this position to the desired value.

Min Vent: This is the position of the air inlet during the On Time portion of a minimum ventilation cycle.

Stage #x: Assign an inlet opening (in %) with the startup of each fan stage.

Stage #x max: Assign the inlet opening that is reached when the variable-speed fan stage reaches its maximum intensity.

Over-Opening Settings:

Opening: Assign an inlet position to the over-opening stage.

Bandwidth: Set the temperature range over which the inlet gradually opens from the position associated with the last fan stage towards the over-opening position (see graphic in section 6.6.1).

6.8 Cool Cells

The controller can control one cool cell output. This cooling system reduces the air temperature by evaporation of water into the air stream.

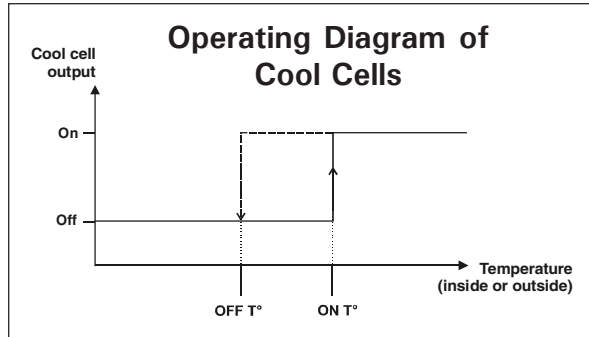

Principle of operation:

The cool cell output can either operate according to the inside temperature or outside temperature: it starts running in timer mode when the inside (or outside) temperature rises and reaches the output's start temperature; the output stops when temperature falls below a user-defined value. It can also stop when humidity levels are too high (see RH Compensation in chapter 10).

Start / stop temperatures:

Operating temperatures of the cool cell output can either be related to the set point – which means the controller automatically adjusts them when the set point changes – or they can be set as absolute values. Refer to the Installation Setup chapter to choose if the output follows the set point or not (sec. 4.5).

Operating time range:

You can specify a period of time over which the cool cell output is allowed to run. This allows deactivating the mist output at night for instance.

Cool Cell LED:

The Cool Cell LED located on the faceplate of the controller tells the status of cooling cycles:

- LED is Off: Cool cell output is off.
- LED is On: On Time of a cool cell cycle;
- LED blinks: Off Time of a cool cell cycle.

Settings

Select:

- Main menu
- Start/Stop*
- Cool Cells**

* A password may be required to access this menu.

** Accessible if the cool cell output is enabled in the Installation Setup (section 4.5).

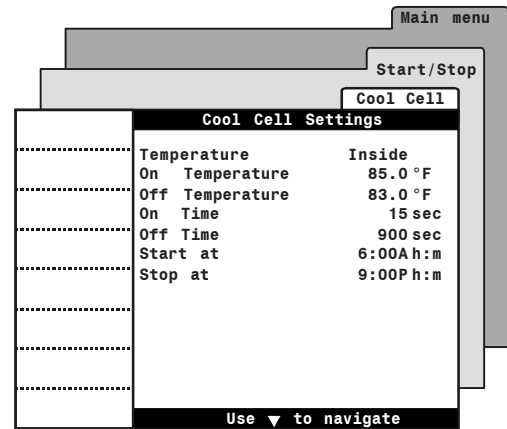

- Set the following parameters:

Temperature: Select "inside" if the operation of cool cells is based on the inside temperature; select "outside" if it is based on the outside temperature.

On temperature: Select the temperature (inside or outside T°) at which the cool cell output starts.

Off temperature: Select the temperature (inside or outside T°) below which the cool cell output stops.

On & Off times: Set the on & off times of the cool cell timer.

Start & stop at: Specify the period of time over which the output can run.

6.9 Misting Output

The controller can control one misting output. When the room temperature reaches the start temperature of the output, mist units are activated and run in timer mode according to their minimum timer (*Min On Time & Min Off Time*). Then, as temperature rises, a gradual transition is made from the minimum timer towards the maximum timer (*Max On Time & Max Off Time*). The second mist timer is fully used when the room temperature reaches the *Maximum Temperature* parameter setting. The misting output is disabled when the temperature falls below a user-defined value. It can also stop when humidity levels are too high (see RH Compensation in chapter 10).

Start / stop temperatures:

Operating temperatures of the mist output can either be related to the set point – which means the controller automatically adjusts them when the set point changes – or they can be set as absolute values. Refer to the Installation Setup chapter to choose if the output follows the set point or not (sec. 4.5).

Operating time range:

You can specify a period of time over which the mist output is allowed to run. This allows deactivating the mist output at night for instance.

Mist LED:

The Mist LED located on the faceplate of the controller tells the status of misting cycles:

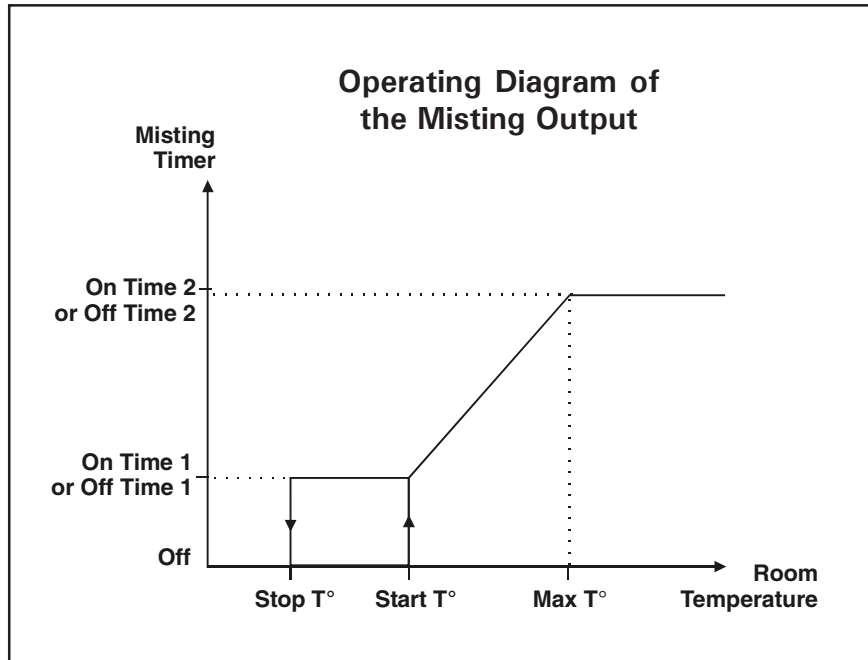

- LED is Off: Mist output is off.
- LED is On: On Time of a misting cycle;
- LED blinks: Off Time of a misting cycle.



EXPERT SERIES 2 BASIC

Settings

Select:

-  Main menu
-  Start/Stop*
-  Misting **

* A password may be required to access this menu.

** Accessible if the misting output is enabled in the Installation Setup (section 4.5).

- Set the following parameters:

On temperature:

Select the temperature at which the misting output starts.

Off temperature:

Select the temperature below which the misting output stops.

Minimum On & Off times:

Set the on & off times of the minimum misting timer.

Maximum Temperature:

Set the temperature at which the maximum misting timer if used.

Maximum On & Off times:

Set the on & off times of the maximum misting timer.

Start & stop at:

Specify the period of time over which the output can run.

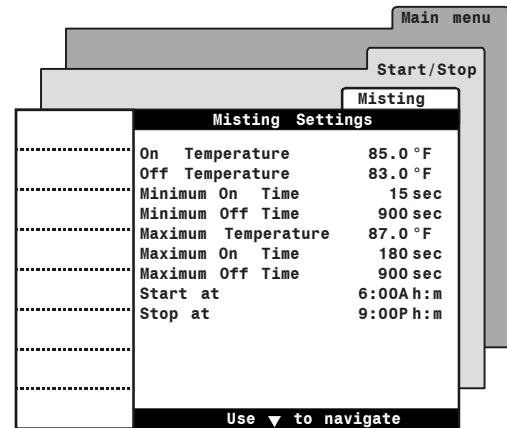

6.10 Stir Fans

The controller can control one stir fan output. This output can operate in three different ways:

1. Stir fans in hot temperature conditions:

If the temperature in the room is too high, stir fans can be enabled to create an air draft to cool down the animals. When they are used for this purpose, stir fans start operating continuously when the room temperature reaches the output's start temperature. The output is disabled when the temperature falls below its stop temperature (see graph on the right).

2. Stir fans in cold temperature conditions:

When the room temperature is too low, stir fans can be activated to disperse the warm air produced by heating units uniformly throughout the building. When they are used for this purpose, stir fans start running in timer mode when the room temperature falls below the output's start temperature. They are disabled when the room temperature rises and reaches the output's stop temperature (see graph on the right).

3. Stir fans used to reduce temperature differences between probes:

Stir fans can start running in timer mode when there is a considerable temperature difference between the reading of two probes. This function is used to ensure the uniformity of the temperature in the house. When they are used for this purpose, stir fans start running when the difference of temperature between two probes exceeds a user-defined temperature limit; they stop when the temperature difference between the probes gets 0.5°F (0.3°C) below the limit (see graph on the right).

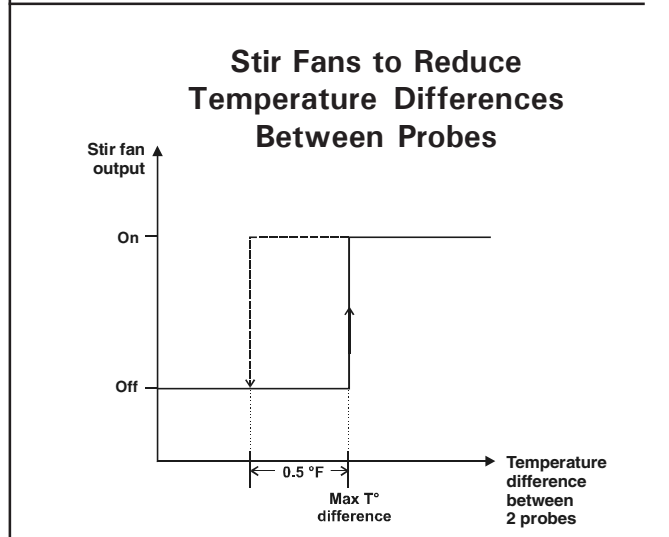
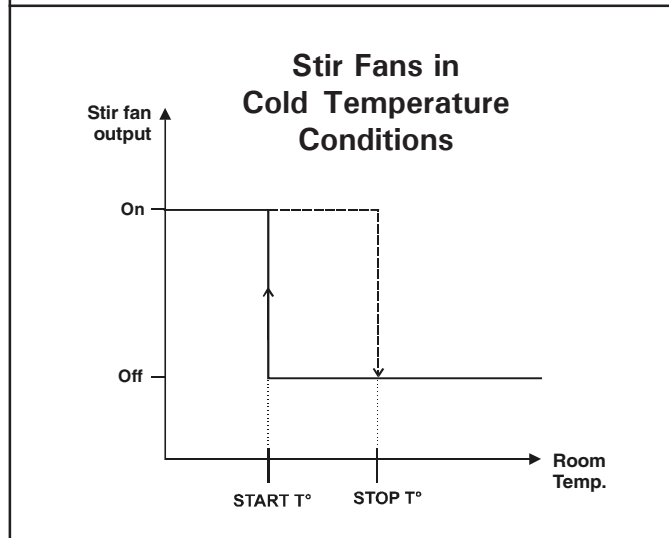
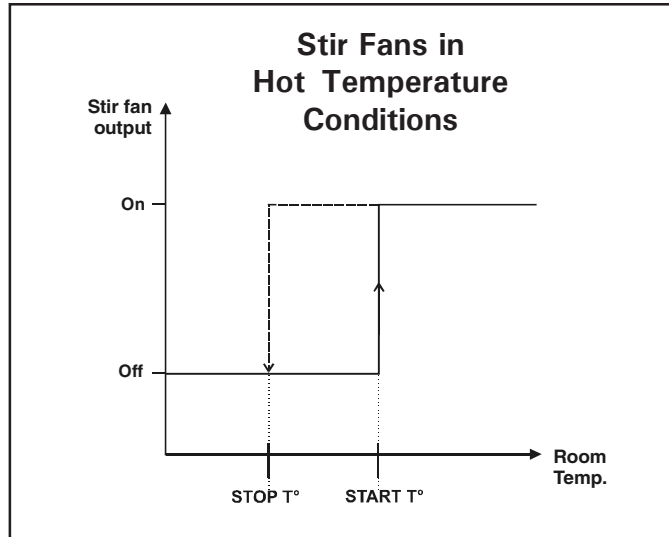

Start / stop temperatures:

Operating temperatures of the stir fan output can either be related to the set point – which means the controller automatically adjusts them when the set point changes – or they can be set as absolute values. Refer to the Installation Setup chapter to choose if the output follows the set point or not (sec. 4.5).



Settings

Select:

-  Main menu
-  Start/Stop*
-  Stir Fan**

* A password may be required to access this menu.

** Accessible if the stir fan output is enabled in the Installation Setup (section 4.5).

- Set the following parameters:

Hot temperature

Select "Yes" if you want to use the stir fan output in hot temperature conditions.

Cold temperature

Select "Yes" if you want to use the stir fan output in cold temperature conditions.

Probe differential

Select "Yes" if you want to use the stir fan output to reduce temperature differences between probes.

Hot start/stop temperature

If stir fans are used in hot temperature conditions, set the room temperature above which the output starts and below which it stops.

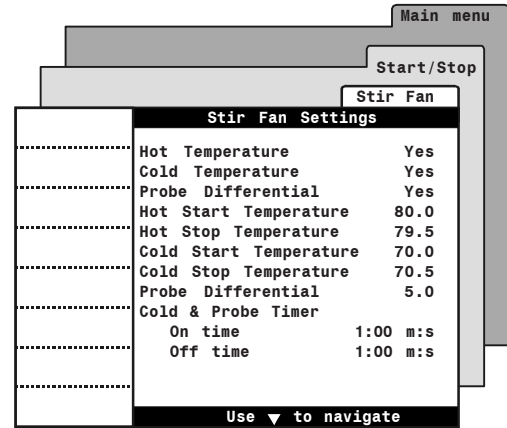

Cold start/stop temperature

If stir fans are used in cold temperature conditions, set the room temperature below which the output starts and above which it stops.

Probe differential

If stir fans are used to reduce temperature differences between probes, set the maximum allowable temperature difference. The output starts when the difference between two probe readings exceeds this value.

Cold and probe timer

Stir fans operate according to a timer when they are used in cold temperature conditions and when they are used to reduce temperature differences between probes. Set the on and off times of the stir fan timer.

7. HEATING

7.1 Heating Stages

The controller can control three independent heating stages. These stages are independent from one another and each operate according to their own temperature settings and probe selection.

An heating stage starts when the temperature reading of its assigned probes falls below the stage's start temperature. The stage stops when the temperature rises and reaches the stage's stop temperature.

Start and stop temperatures of the heating output are related to the set point. This means that when the set point changes, these temperatures are adjusted accordingly.

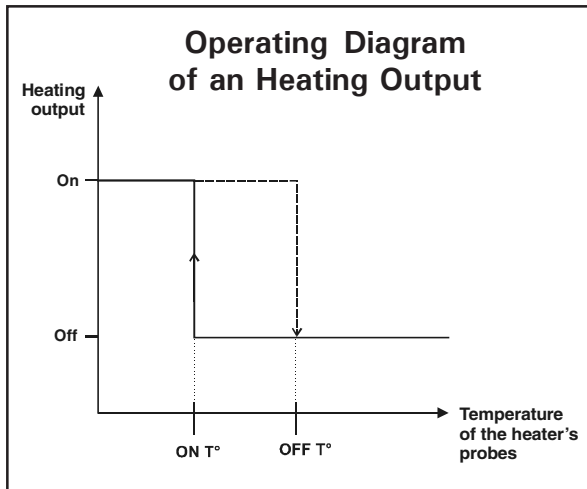

Settings

Select:

- Main menu
- Start/Stop*
- Heaters

* A password may be required to access this menu.

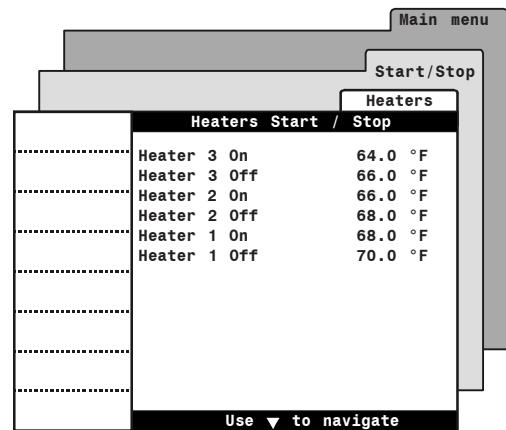

- Set the following parameters:

On temperature

Set the temperature below which each heating stage starts.

Off temperature

Set the temperature at which each heating stage stops. Note that the *Off Temperature* of an heating stage must be at least 0.5°F (0.3°C) higher that its *On Temperature*.

7.2 Heat Lamps (0-10V)

The controller has two 0-10V outputs that can either be used to control heat lamps, heat mats, inlets or fans. To operate these outputs, the controller refers to the average temperature reading of their assigned temperature probes (see sec. 4.7.3). This section explains how 0-10V heat lamps work.

0-10V heat lamps start at their minimum intensity when the temperature falls below the start temperature of the output. The intensity of heat lamps increases as the temperature decreases; the maximum intensity is reached when the temperature falls below the *Max. Temperature* parameter setting.

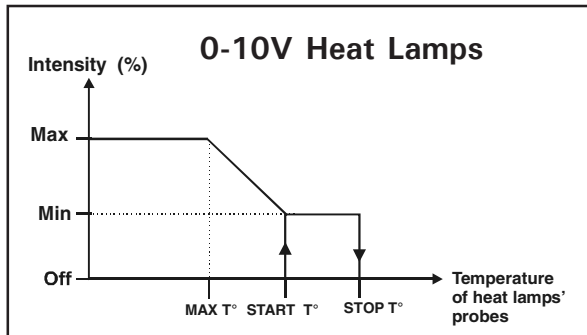



0-10V Mode: Automatic / Manual

You can manually control the intensity of a 0-10V output by using the manual control mode. While this mode is used, the controller stops controlling the output and lets you choose the intensity of the output.

Settings

Select:

-  Main menu
-  Start/Stop*
-  0-10V**
-  Select a 0-10V Heat Lamp output*

* A password may be required to access this menu.

** Accessible if a 0-10V heat lamp output is enabled in the Installation Setup (section 4.5).

Main menu	
Start/Stop	
0-10V	
0-10V #X	
0-10V Output #X Heat Lamp	
Mode	Automatic
Current Output	0 %
Start Temperature	70.6 °F
Minimum	40
Maximum	100
Max Output at	68.6 °F
Stop at	71.1 °F

- Set the following parameters:

Mode: Set the operating mode of the 0-10V output: select "Automatic" if you want the controller to control the output or select "Manual" to specify the intensity of the output yourself.

Current output: This is the current intensity of the output. This intensity can be modified while the manual mode is enabled above.

Start temperature: Set the start temperature to the desired value. Note that this temperature can be set as a fix value (absolute) or it can be related to the set point: this means that when the set point changes, the start temperature is adjusted by the same amount. (refer to section 4.5 to specify if the start temperature of the 0-10V follows the set point or not).

Minimum & max intensities: Set the minimum and maximum intensities of the 0-10V output. The maximum intensity of the output must be greater than the minimum intensity parameter value.

Maximum output at: This is the temperature at which the output reaches its maximum intensity. It must be set to a higher temperature value than the start temperature.

Stop at: This is the temperature below which the output stops.

7.3 Heat Mats (0-10V)

The controller has two 0-10V outputs that can either be used to control heat lamps, heat mats, inlets or fans. To operate these outputs, the controller refers to the average temperature reading of their assigned temperature probes (see sec. 4.7.3). This section explains how a 0-10V heat mat works.

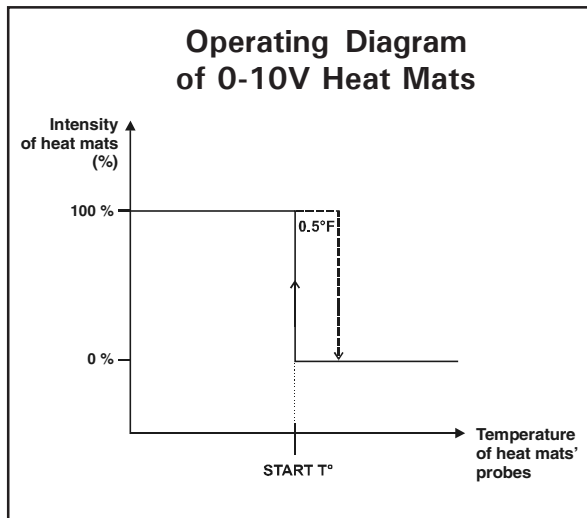

0-10V heat mats starts operating at its full intensity (100%) when the average temperature of chosen sensors reaches the start temperature of the output. It is disabled when the temperature rises 0.5°F (0.3°C) above the start temperature.

0-10V Mode: Automatic / Manual

You can manually control the intensity of a 0-10V output by using the manual control mode. While this mode is used, the controller stops controlling the output and lets you choose the intensity of the output.

Settings

Select:

- Main menu
- Start/Stop*
- 0-10V**
- Select a 0-10V Heat Mat output*

* A password may be required to access this menu (sec. 4.2).

** Accessible if a 0-10V heat mat output is enabled in the Installation Setup (section 4.5).

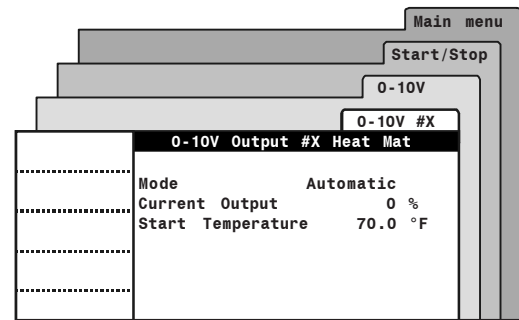

- Set the following parameters:

Mode: Set the operating mode of the 0-10V output: select “Automatic” if you want the controller to control the output or select “Manual” to specify the intensity of the output yourself.

Current output: This is the current intensity of the output. This intensity can be modified while the manual mode is enabled above.



Start temperature: Set the start temperature to the desired value. Note that this temperature can be set as a fix value (absolute) or it can be related to the set point: this means that when the set point changes, the start temperature is adjusted by the same amount. (refer to section 4.5 to specify if the start temperature of the 0-10V follows the set point or not).

8. LIGHTS

The controller can control one light output. The lights turn on when the *On Time* of a light cycle is reached and turn off at the *Off Time*. In all, you can program up to 5 daily light cycles.

Settings

Select:

-  Main menu
-  Start/Stop*
-  Lights**

* A password may be required to access this menu.

** Accessible if the light output is enabled in the Installation Setup (section 4.5).

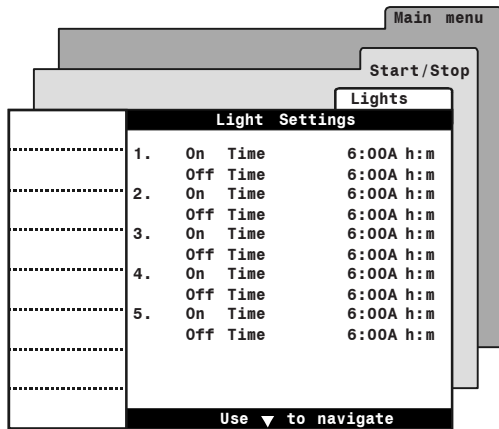

- Set the following parameters:

On & Off Times:

Set the On and Off times of each lighting cycle to the desired value. If 5 cycles are not required, set the On and Off Times of unused cycles to the same value.

9. CLOCK OUTPUTS



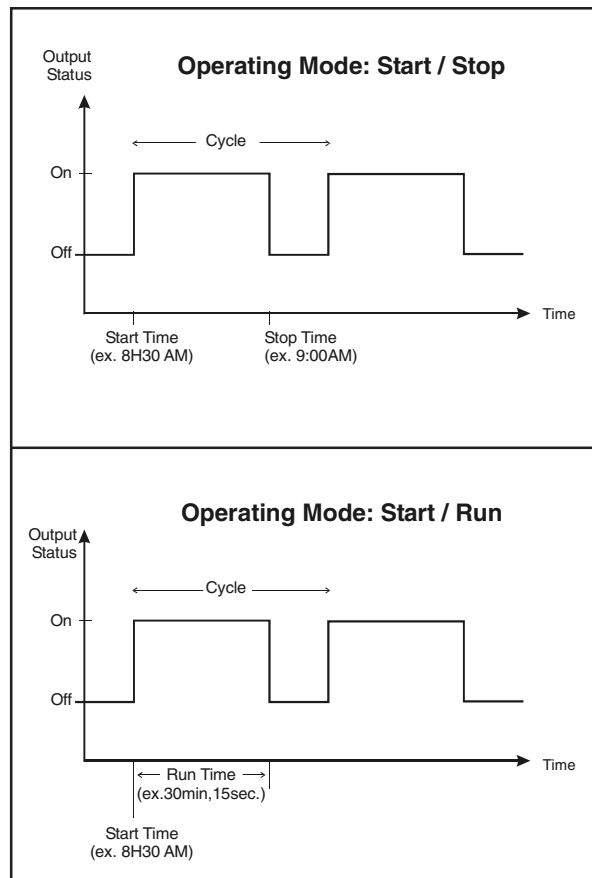

The controller has two outputs to control various devices using the real-time clock. These clock output can use up to 12 timer cycles. Refer to the *Installation Setup* to select the number of timer cycles required (section 4.5).

A clock output starts when the *On Time* of a timer is reached; it either stops after a user-defined running time or at the *Off Time*, depending on chosen option. The following diagrams show both possibilities:



Settings

Select:

-  Main menu
-  Start/Stop*
-  Clocks**
-  Clock #x

* A password may be required to access this menu.

** Accessible if at least 1 clock output is enabled in the Installation Setup (section 4.5).

- Set the following parameters:

Clock mode

The clock mode allows stopping a clock output at a certain time of the day or after a certain run time. Select "Start/Stop" to specify the time at which each cycle starts and stops or select "Start/Run" to specify the running time of each cycle. Note that the "Start/Run" option allows stopping cycles with more precision since this mode allows adjusting the seconds.

On Time / Off Time or Run Time

Set the time at which each cycle starts then set the moment at which each cycle ends.

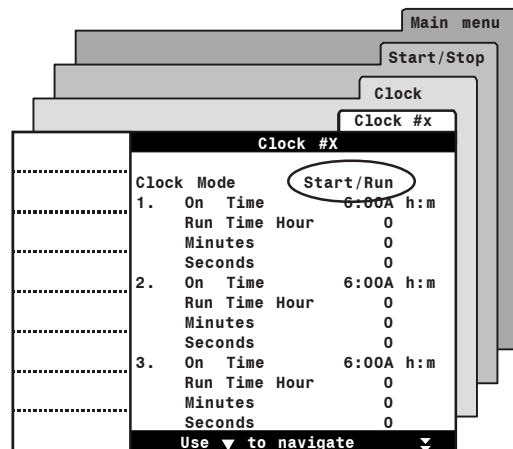
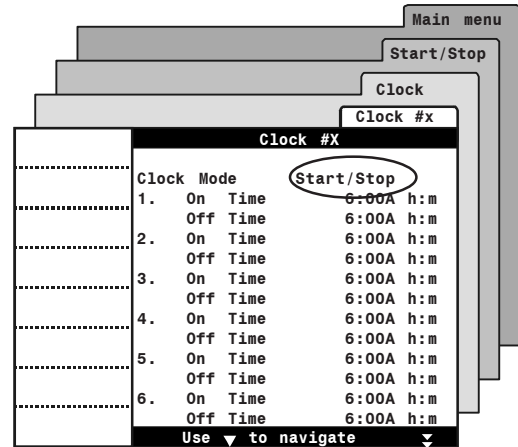

10. RH COMPENSATION

The controller offers different way to compensate for high/low relative humidity (RH) levels in the room. All compensation functions are explained below. To use them, you must enable each desired compensation function in section 4.6.

- **High RH Compensation on the Minimum Ventilation Rate:**

The controller can compensate for high RH levels by enhancing the speed of variable-speed fans in minimum ventilation. When this compensation function is used, the controller adjusts the minimum ventilation rate as a function of the indoor RH level. As the humidity level increases, the controller increases the speed of both variable outputs. The following graph shows how the RH compensation can influence the minimum ventilation speed.

When the RH level exceeds the set point, the controller starts increasing the minimum ventilation fan rate of variable output 1; when the RH level is 5% above the RH set point, the variable output 1 continues increasing in speed and the controller starts increasing the fan speed of variable output 2. The full compensated speed of both variable outputs is reached when the relative humidity level is 10% above the RH set point.

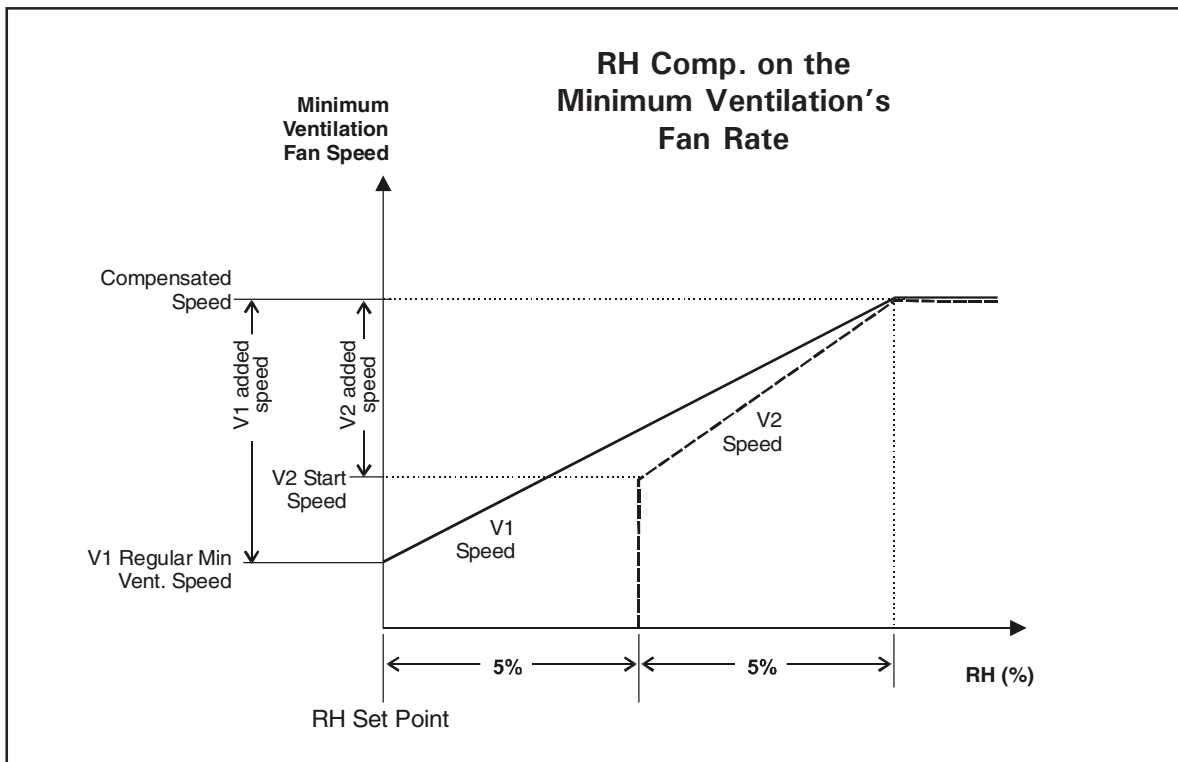

- **High RH Compensation with Heating Outputs:**

When RH levels are too high, the controller can activate heating outputs in timer mode. As RH levels increase, the controller increases the On Time portion of the heating cycle to compensate for the change. The maximum compensated heating On Time is reached when RH levels are 10% above the RH Set Point.

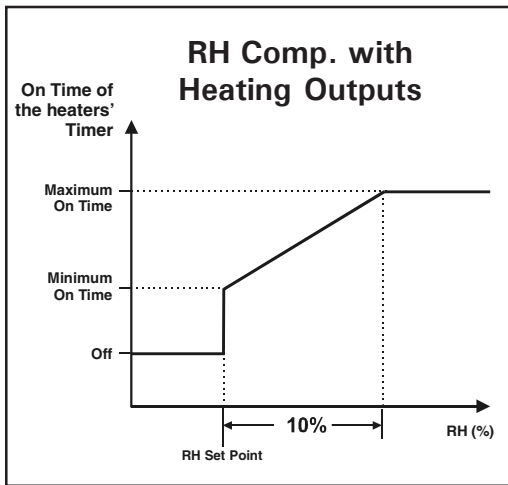

- **High RH compensation with cool cells & misting outputs:**



If RH levels are too high, the controller can stop the misting output and/or cool cell output. These outputs are disabled when RH levels reach the respective RH shutoff limit of each output.

- **Low RH compensation with misting outputs:**

To compensate for low RH levels, the controller can activate the misting output in timer mode. The misting output starts when RH levels decrease below the *Low RH Set Point*.

RH Settings

Select:

-  Main menu
-  RH Comp*

* Accessible if at least one RH compensation function is enabled in section 4.6. In addition, a password may be required to access this menu (section 4.2).

Main menu	
RH Comp.	
RH Set Point	65 %
Min ventilation compensation	
V1 Spd to Add:	30 %
V2 Spd to Add:	30 %
V2 Start Spd :	40 %

- Set the following parameters:

RH Set Point

This is the humidity level above which high RH compensation functions start. Adjustable from 20 to 99% of humidity (select "Off" to disable all high RH comp. functions).

Minimum ventilation compensation

V1-2 Speed to Add:

This is the speed that is added to the regular minimum ventilation of variable fan outputs when RH levels are 10% above the RH set point. Set the compensation speed to the desired value or select "Off" to disable this function.

Accessible if RH compensation on minimum ventilation is enabled in section 4.6.

V2 Start Speed

Select the speed at which variable output 2 runs when the RH level is of 5% above the RH set point.

Accessible if a compensation speed is specified above for variable output 2.

EXPERT SERIES 2 BASIC

Heater compensation

The timer used by heating outputs is made of an On Time and of a Cycle Time. Heating outputs run during the On Time then stop until the end of the Cycle Time. The On Time portion of this cycle increases as RH levels increase.

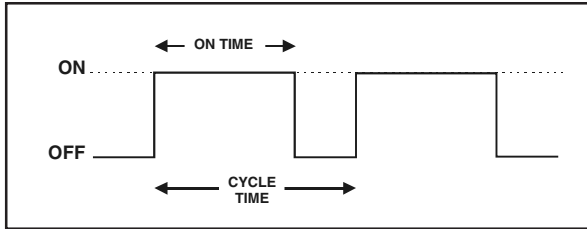

Minimum & Maximum On Times

Set the minimum and maximum On Times of the heating timer. The minimum On Time starts being used when indoor humidity levels reach the RH set point; the maximum On Time is used when humidity levels are 10% above the RH set point.

Accessible if RH compensation with heating outputs is enabled in section 4.6.

Cycle Time:

Set the cycle time of the heating timer.

Accessible if RH compensation with heating outputs is enabled in section 4.6.

Misting outputs on low humidity levels

Accessible if RH comp. on Low RH levels is enabled in section 4.6.

Low Set Point

Set the humidity level below which misting units start running in timer mode or select "Off" to disable this function.

On & Off Times

Set the On and Off Times of the misting timer.

Mist & Cool Cell Shutoff

Set the humidity level above which the misting output and/or the cool cell output stops or select "Off" to disable this function.

Accessible if the mist shutoff compensation and/or cool cell shutoff option is enabled in sec. 4.6.

RH Compensation	
...	
Heater Compensation	
Min On Time	15 sec
Max On Time	45 sec
Cycle Time	300 sec
Mist on Low % Humidity	
Low Set Point	Off %
On time	15 sec
Off Time	900 sec
Mist Shutoff	Off %
Cool Cell shutoff	Off %

11. SOAKING

The controller can control one soaking output to operate cleaning instruments. It automatically activates this output in timer mode when the clean mode starts. The user can also specify the number of soaking cycles that need to be performed or can choose to run these cycles continuously.

Soaking Output LED

The Soaking Output LED located on the faceplate of the controller tells the status of soaking cycles:

- LED is Off: Soaking output is off;
- LED is On: On Time of a soaking cycle;
- LED blinks: Off Time of a soaking cycle.

Settings

Select:

-  Main menu
-  Start/Stop*
-  Soaking**

* A password may be required to access this menu.

** Accessible if the soaking output is enabled in the Installation Setup (section 4.5).

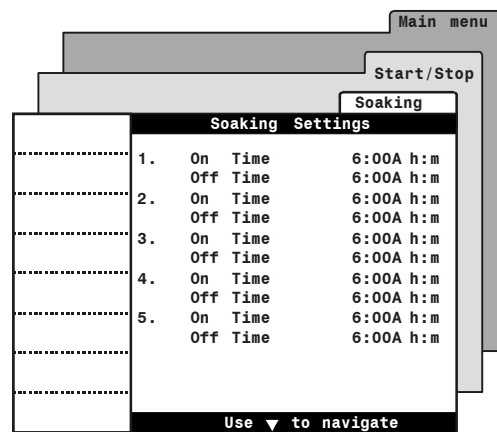

Soaking Settings			
1.	On Time	6:00A	h:m
	Off Time	6:00A	h:m
2.	On Time	6:00A	h:m
	Off Time	6:00A	h:m
3.	On Time	6:00A	h:m
	Off Time	6:00A	h:m
4.	On Time	6:00A	h:m
	Off Time	6:00A	h:m
5.	On Time	6:00A	h:m
	Off Time	6:00A	h:m

Use ▼ to navigate

- Set the following parameters:

On & Off Times

The soaking timer is made of an On Time and of an Off Time. The On Time can be adjusted from 0 to 3600 seconds (1 hour); the Off Time can be adjusted from 0 to 240 minutes (4 hours). Set these parameters to the desired values.

of soaking cycles

Select the number of soaking cycles that need to be performed or select "cont." to run these cycles continuously.

12. ALARMS

When an alarm occurs, the controller lights up the alarm pilot light, displays letters "AL" on the LED display, and post the alarm condition into the alarm log menu. Some user-defined alarm conditions may also activate the alarm relay.

The table on the right gives a list of all possible alarm conditions. Refer to section 12.3 to specify which of these alarm conditions must activate the alarm relay.



Another alarm situation occurs when power to the controller fails. In this case, the alarm relay is activated. When the alarm relay is activated, the normally open contact (-●●-) closes.

Display	Meaning
Low Temp Alarm	Low temperature alarm
High Temp Alarm	High temperature alarm
Low Pressure Alarm	Low static pressure alarm
High Pressure Alarm	High static pressure alarm
Probe #1-8 Defect	A temperature probe is defective
Outside Probe #x Defect	Outside probe #x is defective
Whisker Sw itch Defect	The Whisker sw itch is defective
Water Spill	Water consumption too high
SP Probe Defect	The static pressure sensor is defective
Inside RH Probe Defect	The indoor humidity probe is defective
Outside RH Probe Defect	The outdoor humidity probe is defective
Relay panel comm. Error	Communication is disrupted between the controller and the relay panel.
Inlet potentiometer defect	The potentiometer is defective.
Feeder 1-2 run time exceeded	A feeder has been running continuously on a too long period of time.

12.1 Alarm Log

To access the alarm log

Select:

-  Main menu
-  Alarm Log

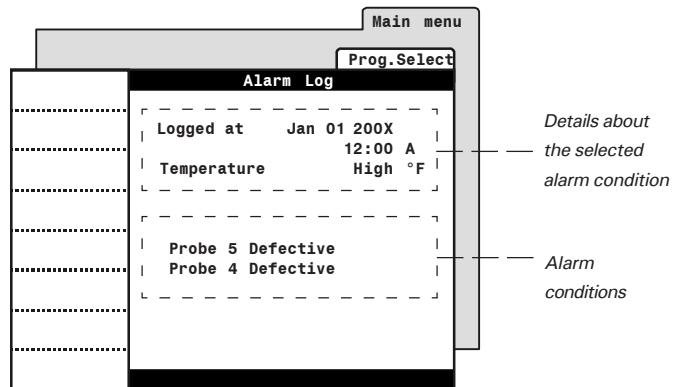

12.2 Alarm Conditions

Temperature Alarms

The diagram below shows how temperature alarms are detected.

When the average room temperature exceeds the high temperature alarm setting, a high temperature alarm is set off. When the average room temperature decreases below the low temperature alarm setting, a low temperature alarm is set off. Although these settings are entered by the user as absolute values, they are defined based on the room set point. They are thus automatically adjusted if the set point changes.

The situation is slightly different when the outside temperature is greater than the room set point. In this case, the outside temperature becomes the reference point (instead of using the set point as a reference). This means an alarm is set off when the room temperature reaches Outside Temperature + High Alarm Offset (the offset being the difference between the high alarm temperature setting and the set point). A third parameter, called the critical temperature, is defined to continue monitoring the indoor temperature for high temperatures. When the indoor temperature reaches the critical high temperature (defined as an absolute value), an alarm is set off.

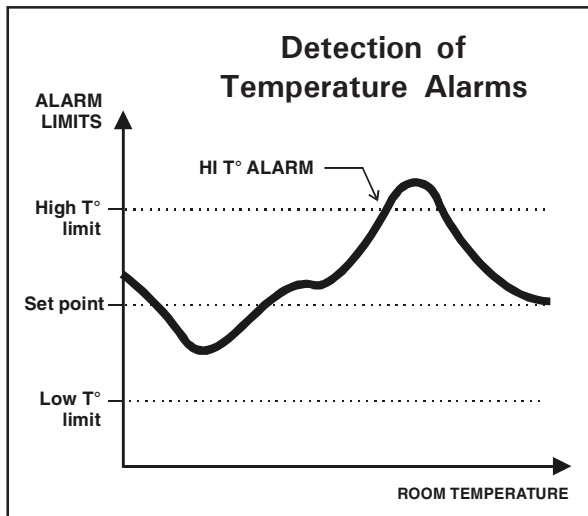

Temperature Alarms in Clean Mode

The controller can monitor low temperature alarms when it is in clean mode. If this alarm condition is used, the controller sounds an alarm when the temperature falls below low alarm limit that is associated to the clean mode.

The low alarm limit used in clean mode is related to the clean mode set point; this means the alarm limit is automatically adjusted when the clean mode set point changes.

Water Spill Alarm

A water spill alarm sets off when the consumption of a water meter exceeds its respective consumption limit. This limit can be adjusted from 0 to 10,000 gallons or liters per 15 minutes.

Static Pressure Alarms



The controller can sound an alarm when the static pressure (SP) level exceeds high or low pressure limits for a certain period of time.

Feeder Alarm

The controller sets off an alarm if a feeder runs continuously on a too long period of time. When this type of alarm occurs, the relay associated with the problematic feeder opens in order to stop the feeder motor. This alarm condition is optional.

12.3 Alarm Settings

Select:

-  Main menu
-  Start/Stop*
-  Alarms

* A password may be required to access this menu (sec. 4.2).

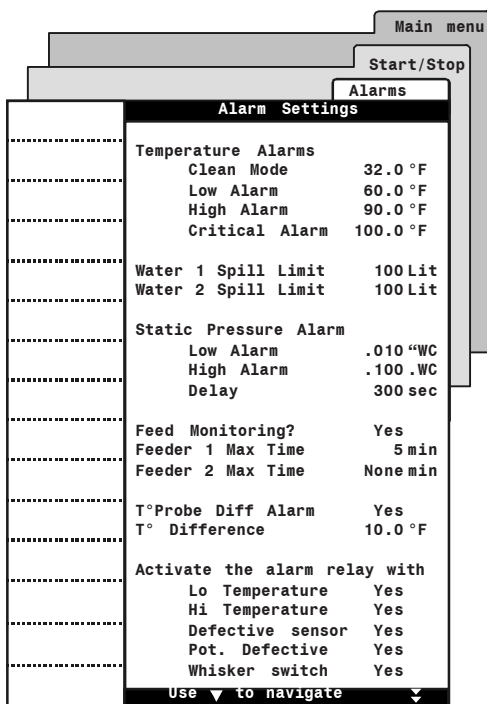

Alarm Settings	
Temperature Alarms	
Clean Mode	32.0 °F
Low Alarm	60.0 °F
High Alarm	90.0 °F
Critical Alarm	100.0 °F
Water 1 Spill Limit 100 Lit	
Water 2 Spill Limit 100 Lit	
Static Pressure Alarm	
Low Alarm	.010 "WC
High Alarm	.100 .WC
Delay	300 sec
Feed Monitoring?	Yes
Feeder 1 Max Time	5 min
Feeder 2 Max Time	None min
T°Probe Diff Alarm	Yes
T° Difference	10.0 °F
Activate the alarm relay with	
Lo Temperature	Yes
Hi Temperature	Yes
Defective sensor	Yes
Pot. Defective	Yes
Whisker switch	Yes
Use ▼ to navigate ▼	

- Set the following alarm limits:

Refer to the previous page to get further information about these parameters).

- **Temperature Alarms**

Clean mode: Set the temperature below which a temperature alarm is set off in clean mode.

Lo/Hi alarm: Set the room temperature below and above which a temperature alarm is set off.

Critical temperature: Set the absolute temperature above which an alarm is set off.

Accessible if an outside temperature probe is enabled (section 4.7.1).

- **Water spill limit**

Specify the maximum amount of water that can be consumed by each water meter per 15 minutes (0-10,000 gal or liters/15 min).

Accessible if a water meter is enabled (sec. 4.7.1)

- **Static pressure limit**

Accessible if a SP probe is enabled (section 4.7.1).

Low / High alarm: Set the pressure levels below and above which an alarm is set off.

Delay: The high or low pressure condition must be maintained on this period of time before the controller sets off the alarm. Set the static pressure alarm delay to the desired value (in seconds).

- **Feeder monitoring**

Select "Yes" if you want the controller to monitor the run time of feeding inputs. If this alarm condition is enabled, set the maximum run time of each feeder (in minutes). Refer to section 4.8 to assign the relay that must open in case of a run time alarm.

Accessible if feeders are enabled (section 4.5).

- **T° Probe Difference**

Select "Yes" if you want the controller to sound an alarm if the temperature difference between two probe readings gets too high.

- **T° Difference**

If the temperature probe difference alarm condition is enabled above, specify the temperature difference above which the controller must sound an alarm.

- **Activate the alarm relay:**

Select "Yes" if you want the controller to activate the alarm relay when the following alarm conditions occur:

- Lo / Hi Temperature
- Lo / Hi Static pressure
- Water spill
- Defective sensors: temperature, humidity, static pressure)
- Communication error with the RP-16
- Defective potentiometer
- Defective whisker switch

[Alarm conditions that activate the alarm relay are common to all programs].

13. MONITORING FUNCTIONS

13.1 Current Conditions

The current condition menu gives a quick overview of the actual conditions in the barn.

Select:



Main menu

- The current conditions (inputs and output) are shown on screen. Use the arrow keys to scroll the display.

Set Point	Current conditions	
Min. Vent.	Clear Warning 1^	No
	Room Temperature	72.3 °F
Start/Stop	Current Stage	2
	Current Probe	Set 1
Inlets	Set Point	70.0 °F
	Inside Humidity	Low %
History	Outside Humidity	Low %
	Static Pressure	.000 "WC
Age/Mortal	Outside T°	High °F
	Heating Stages	xx
Clean Mode	Clock Output	xx
	Inlet 1 Position	0 %
Monitoring	Inlet 2 Position	0 %
	V1 Current Speed	100 %
Program	V2 Current Speed	100 %
Selection	Running Prog:	Program 1
	Temperature Probe 1	72.3 °F
Setup	Temperature Probe 2	72.4 °F
	Temperature Probe 3	72.3 °F
	Temperature Probe 4	72.1 °F
Time/Date	Yesterday Lo Room T	71.2 °F
	Yesterday Hi Room T	74.5 °F
	Yesterday Water 1	0 Gal
	Yesterday Water 2	0 Gal

13.3 History Menus

History menus give a daily record of probe readings and of the animal count. These pieces of information are logged into history menus at midnight. Refer to section 13.2 to consult run time histories (for heaters, water consumption and feeders).

Select:



Main menu



History



Select the desired type of history:

- **Room temperature**

This menu contains the daily minimum and maximum readings of the room temperature of the past 60 days.

- **Probe temperature**

This menu contains the daily minimum and maximum temperature readings of each temperature probe for the past 10 days.

- **Outside temperature**

This menu contains the daily minimum and maximum readings of outside temperature probes for the past 75 days.

Accessible if an outside temperature sensor is enabled (section 4.7.1).

- **Inside relative humidity (RH)**

This menu contains the daily minimum and maximum inside humidity readings of the past 75 days.

Accessible if the inside humidity sensors is enabled (sec. 4.7.1).

- **Outside relative humidity (RH)**

This menu contains the daily minimum and maximum outside humidity readings of the past 75 days.

Accessible if the outside humidity sensors is enabled (sec. 4.7.1).

- **Static Pressure**

This menu contains the daily minimum and maximum static pressure readings of the past 75 days.

Accessible if humidity sensors are enabled (sec. 4.7.1).

- **Mortality / Culled / Marketed**

These menu contains the daily count of mortalities, culled, and of marketed animals of the past 75 days.

Accessible if age-based functions are enabled (section 4.5). In addition, mortality information can be sorted in 8 different history menus (refer to the section 4.5 to enable the desired number of mortality menus).

- **Water Consumption**

This menu contains the daily water consumption measured by each water meter for the past 75 days.

Accessible if at least one water meter is enabled in section 4.7.

- **Heater Run Time**

This menu contains the daily run time of each heating output for the past 75 days.

- **Feeder Run Time**

This menu contains the daily run time of each feeding output for the past 75 days.

Accessible if feeders are enabled in section 4.5.

Resetting the run time of a feeder

To reset the run time of a feeder, select the "Reset" feeder tab then follow the prompts on screen.

13.4 Animal Age & Count

Animal age

Some parameters of the controller can automatically change over time as the animals grow up (curves, programs & tunnel door). Using age-based parameters is optional, refer to section 4.5 to enable or disable the animal age function.

Animal count

(current count / mortality / culled / marketed)

At the beginning of a group, the user must specify the initial number of animals. Afterwards, the user can specify the number of mortalities, culled, and marketed animals as it occurs.



ALL histories of the controller are reset when a new group starts.

Settings

Select:



Main menu



Age/Mortality*

- Accessible if age-based functions are enabled in the Installation Setup (section 4.5)

- Set the following parameters:

Main menu	
Age/Mortal.	
Age & Mortality	
Animal Age	-4 day
Initial Count	1200
Current Count	1200
Start New Group?	No
Select Mortal:	Type 1
New Mortality	0
Today's Mortality	0
Total Mortality	0
New Culled	0
Today's Culled	0
Total Culled	0
New Marketed	0
Today's Marketed	0
Total Marketed	0
Use ▼ to navigate	

- **Animal age**

The animal age can be adjusted from -5 days to 450 days. Negative day values are used to prepare the house before letting the animals in.

- **Initial count**

Enter the initial number of animals in the room before enabling the new group.

- **Current count**

The current count is automatically adjusted as mortalities or culled animals are posted.

- **Starting a new group**

Before starting a new group, enter the animal age and the initial count.



ALL histories of the controller are reset when a new group starts.

- **New mortalities**

Mortality information can be stored in different history menus. Prior to posting a new mortality value, select the proper mortality history menu (type 1-8). After having selected the history type and posted the new mortality value, the mortality value shown on screen automatically goes back to "0". The posted value is then added to the total mortality count and removed from the current animal count.

Refer to section 4.5 to enable the desired number of mortality history menus.

- **New culled**

Post the number culled animals as it occurs. Once it is validated, the parameter value automatically goes back to "0". The posted value is added to the total culled count and removed from the current animal count.

- **New marketed**

When new pigs are sold, post the number marketed animals. Once it is validated, the parameter value automatically returns to "0". The value is added to the total marketed animal count.



13.5 Automatic Reminder

The controller can display warning messages at regular intervals. The automatic reminder allows you to associate a warning message to a servicing activity for instance then decide the frequency at which this servicing activity must be performed. In all, the controller can display 3 different warning messages.

When a warning message is active, the word "Warning" is displayed on screen, along with the message number.

Settings

Select:

-  Main menu
-  Setup*
-  User
-  Warning

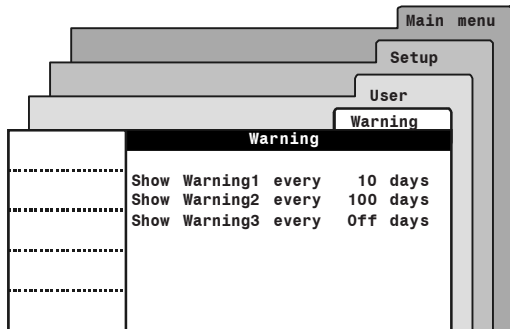

* A password may be required to access this menu (sec. 4.2).

- Set the following parameters:

Show warning 1-3 every

Select the frequency at which each warning message is displayed (1 to 450 days); select "Off" to disable a warning message.

Clearing the Warning Message

Select:

-  Main menu

Main menu	
Current Conditions	
Clear Warning 1?	No
Clear Warning 2?	No
Clear Warning 3?	No
Room Temperature	72.3 °F
Current Stage	2
Current Probe	Set 1

Clear Warning #x ?

This menu appears when a warning message is displayed on screen. Select "Yes" to re-set the timer of the warning message.



It is suggested to write down the meaning and frequency of warning messages 1-3:

Warning #	Meaning	Frequency
warning 1		every ____ days
warning 2		every ____ days
warning 3		every ____ days

14. TECHNICAL SPECIFICATIONS

Type	EXPERT SERIES 2 BASIC
Main supply fuse F1	 4A, slow-blow
Mains supply/frequency	85-250V, 50/60Hz
0-10V outputs 1-2	0-10Vdc, 30mA source max.
Precision on 0-10V outputs	± 1 %
14Vdc output	14 VDC ± 10%, regulated, 250 mA max.
Variable outputs 1,2	230VAC, 10A Max, 1.5HP (230VAC) / 0.5HP (115VAC)
Alarm contact	150 mA, 24 Vac or dc max.
Pot + output	3.0V, 20 mA max.
Potentiometer inputs	1-20 K pot., linear
RH input	4-20 mA
Outside RH input	0-2.5V DC
Temperature inputs	1K @ 77 °F (25 °C), NTC
Relays 1-20	Dry contact 15 A RES, 50/60 Hz 16 FLA @ 120 VAC (1HP, 746 W) 12 FLA @ 240 VAC (2HP, 1490 W)
Housing	IP54, plastic casing
Operating temperature	32 to 104°F (0 to 40 °C)
Storage temperature	5 to 122 °F (-15 to 50 °C)
Ambient relative humidity	max. 95%
Pollution degree	2
Altitude	Up to 2000m

15. MEMORY CARD

15.1 Principle of Operation

The memory card allows you to upgrade the firmware or software of your controller without losing your parameter settings (firmware and/or soft-

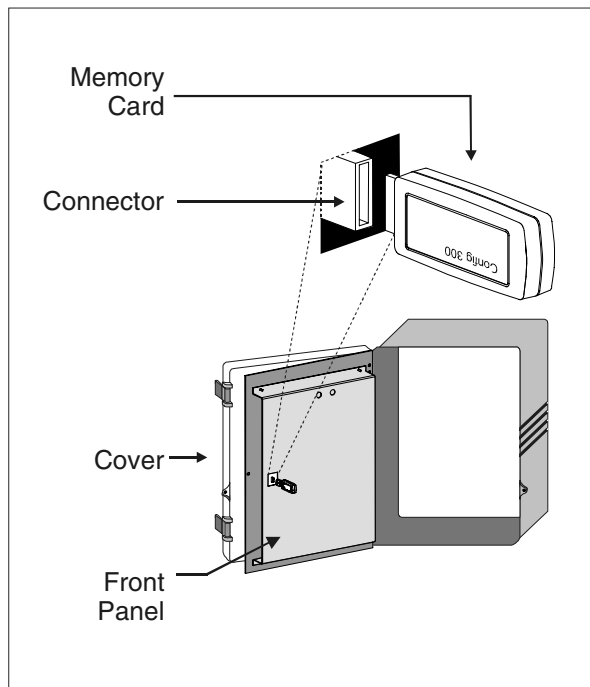

ware upgrade). The card can also be used to make a backup of your controller settings or to copy these settings on another controller of the same type.

Various kind of files can be stored on the card: configuration files (*.cfg files) and/or firmware files (*.fir and *.bin files). Refer to section 15.3 to load or save a configuration file; refer to section 15.4 to upgrade the firmware.

15.2 Accessing the Transfer Menu

1. Unscrew the screws located on the controller's front panel then open the panel.
2. Insert the memory card in the connector located on the electronic board located on the back of the front panel (see illustration).
3. Close the front panel then simultaneously press the up- and down-arrow keys for 3 seconds to display the transfer menu.

Select the desired transfer menu:

- Memory Card → Controller
or
- Controller → Memory Card

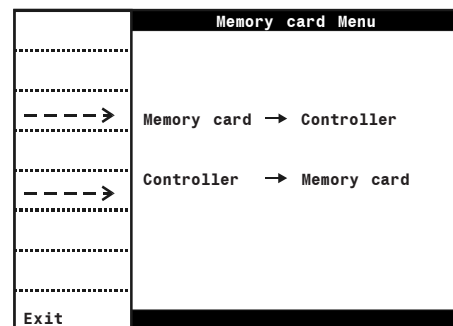

15.3 Configuration Transfer

Configuration Files (*.cfg)

Configuration files are a set of instructions that tells the controller what to do. These files are divided into three parts:





- 1) Software (screen menus)
- 2) User data (parameter settings)
- 3) Potentiometer calibration

15.3.1 Installing a New Configuration

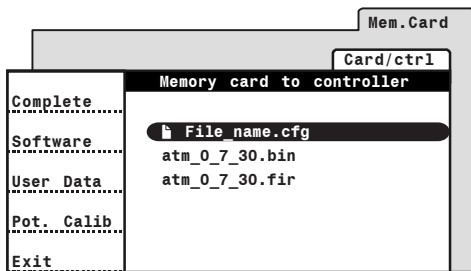
The following procedure shows how to install a new configuration in your controller. You can choose to install the whole new configuration or to install a specific component of it.

- Access the transfer menu as explained in section 15.2 and select the **"Memory card to controller"** menu.



- Select the proper configuration file (*.cfg) on the main screen. The  icon indicates which files can be used for the transfer.
- Press the button that corresponds to the component(s) you want to install:
 -  Complete (all components)
 -  Software (screen menus)
 -  User data (parameter settings)
 -  Pot. Calib (inlet calibration settings)
- Once the transfer is over, press Exit then remove the memory card from the connector.

You can save your controller's configuration on the card or you can install a new configuration into your controller. Note that it is now possible to install a specific component of the configuration without affecting the two other components. For instance, you can upload new controller software without affecting your calibration & parameter settings.

15.3.2 Saving a Configuration on the Card

The following procedure shows how to save your controller's configuration into the memory card. This will create a configuration file (*.cfg) on the card.

- Access the transfer menu as explained in section 15.2 and select the **"Controller to Memory card"** menu.
- The name of the configuration file (*.cfg) is shown at the top of the screen and the table at the bottom gives information about the memory card. Press "Complete" to save your controller's configuration on the card.

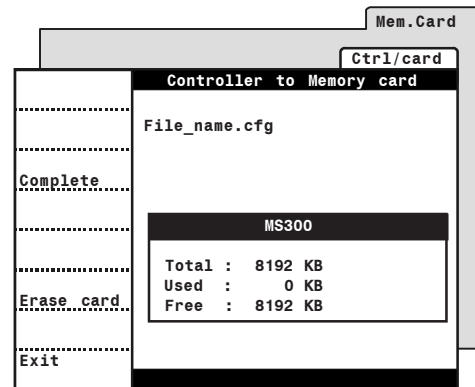

- Once the transfer is over, press Exit then remove the memory card from the connector.

15.4 Firmware Update

Firmware Files (*.fir)

The controller's firmware contains instructions and data responsible for controlling the controller. When a new firmware version is available, you can install it in your controller by downloading a firmware file (*.fir) from the card. Upgrading the firmware will not affect your parameter settings.

- Access the transfer menu as explained in section 15.2 and select the **"Memory card to controller"** menu.
- Press and hold the up- and down-arrow keys simultaneously for 3 seconds. The Firmware Update menu is displayed.
- Read the warning message carefully then press Next.

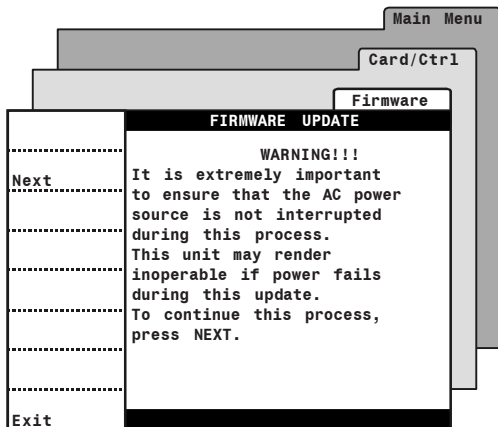

- Select the proper firmware file (*.fir) on the main screen. The  icon indicates which files can be used for the transfer.

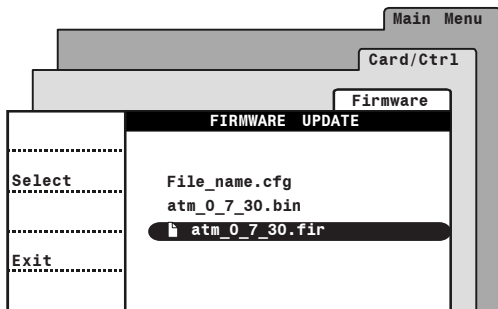

- Press "Select" to get information about the selected firmware file (*.fir).

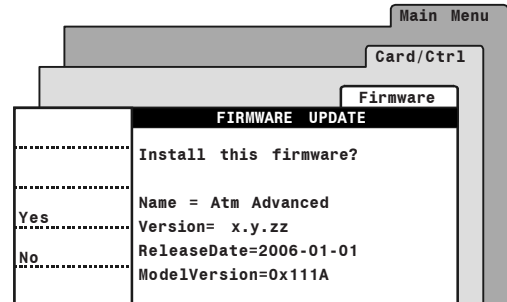

- Press "Yes" to install the selected firmware or select "No" to go back to the previous menu.
- Once the transfer is over, press Exit then remove the memory card from the connector.

15.5 Erasing the Memory Card

Follow this procedure to delete all the content of the memory card.

- Access the transfer menu as explained in section 15.2 and select the **"Controller to Memory card"** menu.

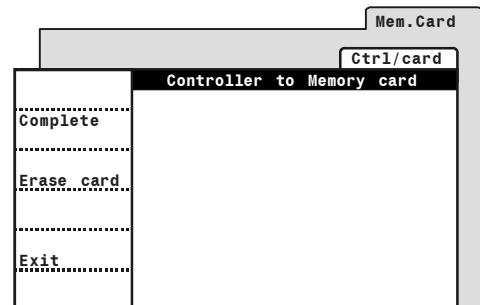

- Press "Erase card" to delete all files that are stored on the card.
- Once the card is erased, press Exit then remove the memory card from the connector.

16. WORK SHEETS

CLIENT

Name: _____

Address: _____

City: _____

Tel.: _____

Fax: _____

E-mail: _____

INSTALLER

Name: _____

Address: _____

City: _____

Tel.: _____

Fax: _____

E-mail: _____

16.1 Relay Assignment Template PROGRAM 1

	INTERNAL RELAYS 1-20																				16 OUTPUT RELAY PANEL																	
	1	2	3	4	5	6	7	8	9	10	11	12	13	14	15	16	17	18	19	20	V1	V2	1	2	3	4	5	6	7	8	9	10	11	12	13	14	15	16
Module relay #:	1	2	3	4	5	6	7	8	9	10	11	12	13	14	15	16	17	18	19	20	V1	V2	1	2	3	4	5	6	7	8	9	10	11	12	13	14	15	16
Corresponds to	1	2	3	4	5	6	7	8	9	10	11	12	13	14	15	16	17	18	19	20	V1	V2	1	2	3	4	5	6	7	8	9	10	11	12	13	14	15	16
Heater 3																																						
Heater 2																																						
Heater 1																																						
Min. vent. on/off fans																																						
Fan stage 1																																						
Fan stage 2																																						
Fan stage 3																																						
Fan stage 4																																						
Fan stage 5																																						
Fan stage 6																																						
Fan stage 7																																						
Fan stage 8																																						
Fan stage 9																																						
Fan stage 10																																						
Fan stage 11																																						
Fan stage 12																																						
Tunnel door 1 OPN																																						
Tunnel door 1 CLO																																						
Tunnel door 2 OPN																																						
Tunnel door 2 CLO																																						
Inlet 1 OPN																																						
Inlet 1 CLO																																						
Inlet 2 OPN																																						
Inlet 2 CLO																																						
Natural curtain OPN																																						
Natural curtain CLO																																						
Natural curtain OPN																																						
Natural curtain CLO																																						
Stir fans																																						
Feeder relay																																						
Backup relay																																						
Misting																																						
Soaking																																						
Cool cell																																						
Time Clock 1																																						
Time Clock 2																																						
Lights																																						
Module relay #:	1	2	3	4	5	6	7	8	9	10	11	12	13	14	15	16	17	18	19	20	V1	V2	1	2	3	4	5	6	7	8	9	10	11	12	13	14	15	16
Corresponds to	1	2	3	4	5	6	7	8	9	10	11	12	13	14	15	16	17	18	19	20	V1	V2	1	2	3	4	5	6	7	8	9	10	11	12	13	14	15	16

EXPERT SERIES 2 BASIC

16.2 Probe Assignment Worksheet

Output	Probes (program 1)								Probes (program 2)								Probes (program 3)							
	1	2	3	4	5	6	7	8	1	2	3	4	5	6	7	8	1	2	3	4	5	6	7	8
Heater 3																								
Heater 2																								
Heater 1																								
Room T°																								
Probe set 2																								
0-10V #1																								
0-10V #2																								
Natural curtain 1																								
Natural curtain 2																								

16.3 Installation Setup Worksheet

	Installation Setup Menu		
	Program 1	Program 2	Program 3
# feeders	___ (0-2)	___ (0-2)	___ (0-2)
# heating stages	___ (0-3)	___ (0-3)	___ (0-3)
# fan stages	___ (1-12)	___ (1-12)	___ (1-12)
# clock output	___ (0-2)	___ (0-2)	___ (0-2)
# 0-10V outputs	___ (0-2)	___ (0-2)	___ (0-2)
# natural ventilation curtains	___ (0-2)	___ (0-2)	___ (0-2)
# tunnel doors	___ (0-2)	___ (0-2)	___ (0-2)
Number of inlets	___ (0-2)	___ (0-2)	___ (0-2)
Variable fan outputs	<input type="checkbox"/> V1 <input type="checkbox"/> V1-V2 <input type="checkbox"/> None	<input type="checkbox"/> V1 <input type="checkbox"/> V1-V2 <input type="checkbox"/> None	<input type="checkbox"/> V1 <input type="checkbox"/> V1-V2 <input type="checkbox"/> None
Inlet 1 mode	<input type="checkbox"/> Timer <input type="checkbox"/> Potentiometer		<i>(Common to all programs)</i>
# Mortality History	___ (1-8)		
Close inlets in natural vent?	<input type="checkbox"/> Yes <input type="checkbox"/> No		<i>(Common to all programs)</i>
0-10V 1 signal	<input type="checkbox"/> 0-10V <input type="checkbox"/> 10-0V		<i>(Common to all programs)</i>
0-10V 1 function	<input type="checkbox"/> ventilation <input type="checkbox"/> heat lamp <input type="checkbox"/> heat mat <input type="checkbox"/> inlet		<i>(Common to all programs)</i>
0-10V 1 follows set point ?	<input type="checkbox"/> Yes <input type="checkbox"/> No		<i>(Common to all programs)</i>
0-10V 2 signal	<input type="checkbox"/> 0-10V <input type="checkbox"/> 10-0V		<i>(Common to all programs)</i>
0-10V 2 function	<input type="checkbox"/> ventilation <input type="checkbox"/> heat lamp <input type="checkbox"/> heat mat <input type="checkbox"/> inlet		<i>(Common to all programs)</i>
0-10V 2 follows set point ?	<input type="checkbox"/> Yes <input type="checkbox"/> No		<i>(Common to all programs)</i>
Curtain 1 compensation ?	<input type="checkbox"/> Yes <input type="checkbox"/> No	<input type="checkbox"/> Yes <input type="checkbox"/> No	<input type="checkbox"/> Yes <input type="checkbox"/> No
Curtain 1 Whisker switch ?	<input type="checkbox"/> Yes <input type="checkbox"/> No		<i>(Common to all programs)</i>
Curtain 2 compensation ?	<input type="checkbox"/> Yes <input type="checkbox"/> No		<i>(Common to all programs)</i>
Curtain 2 Whisker switch ?	<input type="checkbox"/> Yes <input type="checkbox"/> No	<input type="checkbox"/> Yes <input type="checkbox"/> No	<input type="checkbox"/> Yes <input type="checkbox"/> No

EXPERT SERIES 2 BASIC

Installation Setup Worksheet ...

	Installation Setup Menu		
Use misting ?	<input type="checkbox"/> Yes <input type="checkbox"/> No	<input type="checkbox"/> Yes <input type="checkbox"/> No	<input type="checkbox"/> Yes <input type="checkbox"/> No
Mist follows set point ?	<input type="checkbox"/> Yes <input type="checkbox"/> No		<i>(Common to all programs)</i>
Use cool cell ?	<input type="checkbox"/> Yes <input type="checkbox"/> No	<input type="checkbox"/> Yes <input type="checkbox"/> No	<input type="checkbox"/> Yes <input type="checkbox"/> No
Cool cell follows set point ?	<input type="checkbox"/> Yes <input type="checkbox"/> No		<i>(Common to all programs)</i>
Use stir fan ?	<input type="checkbox"/> Yes <input type="checkbox"/> No	<input type="checkbox"/> Yes <input type="checkbox"/> No	<input type="checkbox"/> Yes <input type="checkbox"/> No
Stir fans follow set point ?	<input type="checkbox"/> Yes <input type="checkbox"/> No		<i>(Common to all programs)</i>
Use soaking ?	<input type="checkbox"/> Yes <input type="checkbox"/> No	<input type="checkbox"/> Yes <input type="checkbox"/> No	<input type="checkbox"/> Yes <input type="checkbox"/> No
Use lights ?	<input type="checkbox"/> Yes <input type="checkbox"/> No	<input type="checkbox"/> Yes <input type="checkbox"/> No	<input type="checkbox"/> Yes <input type="checkbox"/> No
Use backup relay ?	<input type="checkbox"/> Yes <input type="checkbox"/> No	<input type="checkbox"/> Yes <input type="checkbox"/> No	<input type="checkbox"/> Yes <input type="checkbox"/> No
Use RP-16 ?	<input type="checkbox"/> Yes <input type="checkbox"/> No		<i>(Common to all programs)</i>
V1 Min speed abs / inlet %	____ %		<i>(Common to all programs)</i>
V1 Motor curve	____ (1 - 10)		<i>(Common to all programs)</i>
V2 Min speed abs / inlet %	____ %		<i>(Common to all programs)</i>
V2 Motor curve	____ (1 - 10)		<i>(Common to all programs)</i>
Use age ?	<input type="checkbox"/> Yes <input type="checkbox"/> No		<i>(Common to all programs)</i>
Use Temp. curve ?	<input type="checkbox"/> Yes <input type="checkbox"/> No		<i>(Common to all programs)</i>
Use Min. Vent. curve ?	<input type="checkbox"/> Yes <input type="checkbox"/> No		<i>(Common to all programs)</i>
Number of programs	____ (1 - 3)		<i>(Common to all programs)</i>
Switch program by age	<input type="checkbox"/> Yes <input type="checkbox"/> No		<i>(Common to all programs)</i>
Switch program by Out T°	<input type="checkbox"/> Yes <input type="checkbox"/> No		<i>(Common to all programs)</i>
Use password ?	<input type="checkbox"/> Yes <input type="checkbox"/> No		<i>(Common to all programs)</i>
Use password level?	____ User 1 ____ User 2 ____ Installer		<i>(Common to all programs)</i>
Clear alarms ?	<input type="checkbox"/> Yes <input type="checkbox"/> No		<i>(Common to all programs)</i>
Digit display	<input type="checkbox"/> T° <input type="checkbox"/> SP <input type="checkbox"/> T°/SP		<i>(Common to all programs)</i>

INDEX

A

- Age
 - see Animals
- Alarms
 - Alarm conditions 72, 73
 - Alarm log 72
 - Reset the alarm log 23
 - Alarm relay 74
 - Alarm settings 74
- Animals
 - Animal count
 - History 76
 - Posting changes to the animal count 77
 - Enabling animal age functions 22
 - Starting a new group 77

B

- Backup
 - Backup relay
 - Activation 21
 - Relay assignment 28
 - Making a backup of the controller 80
- Buttons 11–12

C

- Calibration
 - Inlet calibration
 - Operation & settings 56
 - Probe calibration 26
 - Vent door (inlet) calibration
 - see Vent door/inlet (potentiometer)
 - Water meter calibration 26
- Celsius units 18
- Clean mode
 - Alarms 73, 74
 - Clean mode set point 33
 - Operation & settings 31
- Clock
 - Display : AM/PM or 24hours 18
 - Setting the time and date 14
- Clock outputs
 - # of cycles 19
 - Activation 19
 - Current status 75
 - Operation & settings 66
 - Relay assignment 28
- Compensation
 - see Relative humidity compensation
- Connections 10
- Contrast (LCD screen) 12

- Controller
 - Features 7
 - Firmware update 82
 - Installation setup 19–23
 - Location of the controls 11
 - Mounting instructions 10
 - Software
 - Language selection 12
 - Version 32
 - Technical specifications 79
- Cool cells
 - Activation 21
 - Operation & Settings 58
 - Relay assignment 28
 - RH comp. on the cool cell output
 - Activation 24
 - Principle of operation 69
 - Settings 70
- Copy & Paste function 17
- Culled
 - History 76
 - Posting # of culled animals 77
- Current conditions 75
- Curtains
 - see Natural ventilation curtain
- Curves
 - Min. speed curve
 - Curve offset 39
 - Enable the curve function 22
 - Principle of operation 38
 - Settings 38
 - Motor curve 22
 - Temperature curve
 - Curve offset 35
 - Enable the curve function 22
 - Principle of operation 34
 - Settings 34
- D
- Date 14
- Day / Night
 - Activation 30
 - Day/night times 30
 - Night set point
 - Principle of operation 33
 - Settings 33
 - Night ventilation
 - Activation 30
 - Settings 37
- Display
 - Red LED display
 - Location 11
 - Unit selection 23
- E
- Electrical specifications 79
- English software 12
- Evaporative pads
 - see Cool cells

F

- Fahrenheit units 18
- Fan stages
 - Activation 19
 - Current fan stage in use 75
 - Minimum ventilation
 - see Minimum ventilation
 - Principle of operation 40
 - Relay assignment 28
 - Settings 43
 - Timer relays
 - Principle of operation 40
 - Timer settings 43
 - Transition between stages 1 and 2
 - Principle of operation 41
 - Settings 43
 - Variable fans
 - Activation 20
 - Assignment 29
 - Current speed of the fans 75
 - Minimum fan speed 22
 - Principle of operation 40
- Fan stages (0-10V fans)
 - Activating 0-10 V outputs 19, 20
 - Operation & settings 44
 - Probe assignment 27
- Feeders
 - Activation 19
 - Relay assignment 28
 - Run time alarm
 - Principle of operation 73
 - Settings 74
 - Run time history 76
- Firmware update
 - Principle of operation 82
 - Settings 82
- G
- Gallons 18
- H
- Heat lamp (0-10 V)
 - Activating the 0-10 V output 19, 20
 - Operation & Settings 64
 - Probe assignment 27
- Heat mats (0-10V)
 - Activating the 0-10 V output 19, 20
 - Operation & Settings 65
 - Probe assignment 27
- Heaters
 - Activation 19
 - Current status 75
 - Operation & Settings 63
 - Probe assignment 27
 - Relay assignment 28
 - RH compensation on heaters
 - Activation 24
 - Principle of operation 69
 - Settings 70
 - Run time history 76
- History menus 76
- Humidity
 - see Relative humidity

I

- Inlets (0-10V inlet output)
 - Activation 19, 20
 - Principle of operation 57
 - Probe assignment 27
 - Settings 57
- Inlets (potentiometer-based)
 - Activation 19
 - Calibration
 - Operation & settings 56
 - Current position 75
 - Principle of operation 54
 - Relay assignment 28
 - Settings 55
- Inlets (timer-based)
 - Activation 19
 - Current position 75
 - Principle of operation 50–51
 - Relay assignment 28
 - Resetting the position 53
 - Settings 52
- Inputs
 - Activation 25
 - List of available inputs 7
- Installation setup 19–23
- Installer password
 - see Password

L

- Language selection 12
- LCD screen
 - Backlight button 12
 - Contrast adjustment 12
 - Location 12
- LEDs
 - LED display
 - Location 12
 - Unit selection 23
 - LED meaning 13
- Lights
 - Activation 21
 - Operation & settings 66
 - Relay assignment 28
- Liters 18

M

- Main menu button 11
- Marketed animals
 - History 76
 - Posting # of marked animals 77
- Measuring units 18
- Memory card
 - Erasing the card 82
 - Transfer process 80

Menu selectors 11

- Minimum ventilation
 - Min speed curve
 - see Curves
 - Night ventilation
 - Activation 30
 - Settings 37
 - On Time ramping
 - see Ramping
 - Principle of operation 36–39
 - Relay assignment 29
 - RH Compensation on min vent cycles
 - Activation 24
 - Principle of operation 68
 - Settings 69
 - Settings 37–39
- Misting output
 - Activation 21
 - Operation & settings 59–60
 - Relay assignment 28
 - RH compensation on the mist output
 - Activation 24
 - Principle of operation 69
 - Settings 70

Mortality

- Entering new mortalities 77
- History 76
- Posting # of mortalities 77

Motor curve 22

Mounting instructions 10

N

- Natural ventilation curtain
 - Outside T° compensation 47
 - Outside T° set point 33
 - Principle of operation 45
 - Probe assignment 27
 - Relay assignment 28
 - Settings 46
 - Shutoff fans
 - Principle of operation 47
 - Relay selection 28

Night

- see Day/night

O

- Outputs
 - Activation 19–23
 - List of available outputs 7
 - Relay assignment
 - Clearing the assignment 23
 - Making the assignment 28
- Outside RH
 - see Rel. Humidity (RH)
- Outside T°
 - see Temperature

P

- Parameter adjustment 12
- Password
 - Default user level 22
 - Enable/disable the password 22
 - Entering/changing the password 14–15
 - Retrieving a lost password 15
- Probe
 - Activation 25
 - Assignment 27
 - Calibration 26
 - Connection 10
 - Extension 10
 - Probe sets
 - Current probe set in use 75
 - Principle of operation 48
 - Probe assignment 27
 - Settings 49
- Programs
 - Automatic program switch
 - Activation 22
 - Settings 16, 22
 - Copy/paste program settings 17
 - Current program in use 75
 - Enabling programs 22
 - Principle of operation 16
 - Program selection 16

R

- Ramping (minimum ventilation)
 - Activation 20
 - Principle of operation 42
- Relative humidity (RH)
 - Inside RH sensor
 - Activation 25
 - Calibration 26
 - Current reading 75
 - History 76
 - Outside RH sensor
 - Activation 25
 - Calibration 26
 - Current reading 75
 - History 76
 - RH Compensation
 - Activation 24
 - Principle of operation 68
 - Settings 69
 - RH set point 69
- Relay panel 21
- Relays
 - Alarm relay 74
 - Relay assignment
 - Clearing the assignment 23
 - Making the assignment 28
 - Shutoff fan relays in natural ventilation
 - Principle of operation 47
 - Relay selection 28
 - Timer relays
 - Principle of operation 40
 - Timer settings 43

S

- Screens (LED & LCD) 12
- Sensors
 - see Probes
- Set points
 - RH set point
 - see Relative Humidity 69
 - Temperature set points 33
- Setup (Installation) 19–23
- Simulation (temperature) 32
- Soaking
 - Activation 21
 - Operation & settings 71
 - Relay assignment 28
- Spanish software 12
- Static pressure (SP)
 - Current pressure level 75
 - Measuring units 18
 - Pressure alarms
 - Principle of operation 73
 - Settings 74
 - Probe history 76
 - SP Probe
 - Activation 26
 - Calibration 26
- Stir fans
 - Activation 21
 - Operation & settings 61
 - Relay assignment 28
- Symbols of the manual 6

T

- Technical specifications 79
- Temperature
 - Average room temperature
 - Current average T° 75
 - History 76
 - Probe assignment 27
 - Probe set 2 - probe assignment 27
 - Probe set 2 - temperature settings 49
 - Probe set in use 75
 - Inside temperature probes
 - Activation 25
 - Current probe readings 75
 - History 76
 - Probe assignment 27

- Probe calibration 26
- Outside temperature
 - Activation 25
 - Current probe reading 75
 - History 76
 - Outside T° set point 33
 - Probe calibration 26
- Temperature alarms
 - Principle of operation 73
 - Settings 74
- Temperature set points
 - Clean mode set point 33
 - Current set point 75
 - Night set point 33
 - Operation & settings 33
 - Outside T° set point 33
 - Temperature curve 34, 35
- Temperature simulation 32
- Temperature units 18
- Test mode 32
- Time
 - Setting the time and date 14
 - Time format 18
- Tunnel ventilation
 - Activation 19
 - Current stage in use 75
 - Principle of operation 48
 - Probe set 2
 - Current probe set in use 75
 - Probe assignment 27
 - Temperature settings 49
 - Settings 49

U

- Units 18
- User password
 - see Password

V

- Variable-speed fans
 - see Fan stages
- Vent door/inlet (potentiometer)
 - Calibration
 - Loading an existing calibration 81
- Ventilation
 - Fans
 - see Fans stages
 - Min. ventilation
 - see Minimum ventilation
- Version (software) 32

W

- Warning messages 78
- Water meter
 - Activation 25
 - Calibration 26
 - Consumption history 76
 - Measuring units 18
 - Water spill alarm 73, 74
- Whisker switch 21, 47
- Wiring 10
- Worksheets 83–86