

Combined Ventilation Controller

RVS-24HA

6-stage Control for Power Applications
2 variable speed stages, 2 cooling/mister cycle stages
and 2 thermo stages

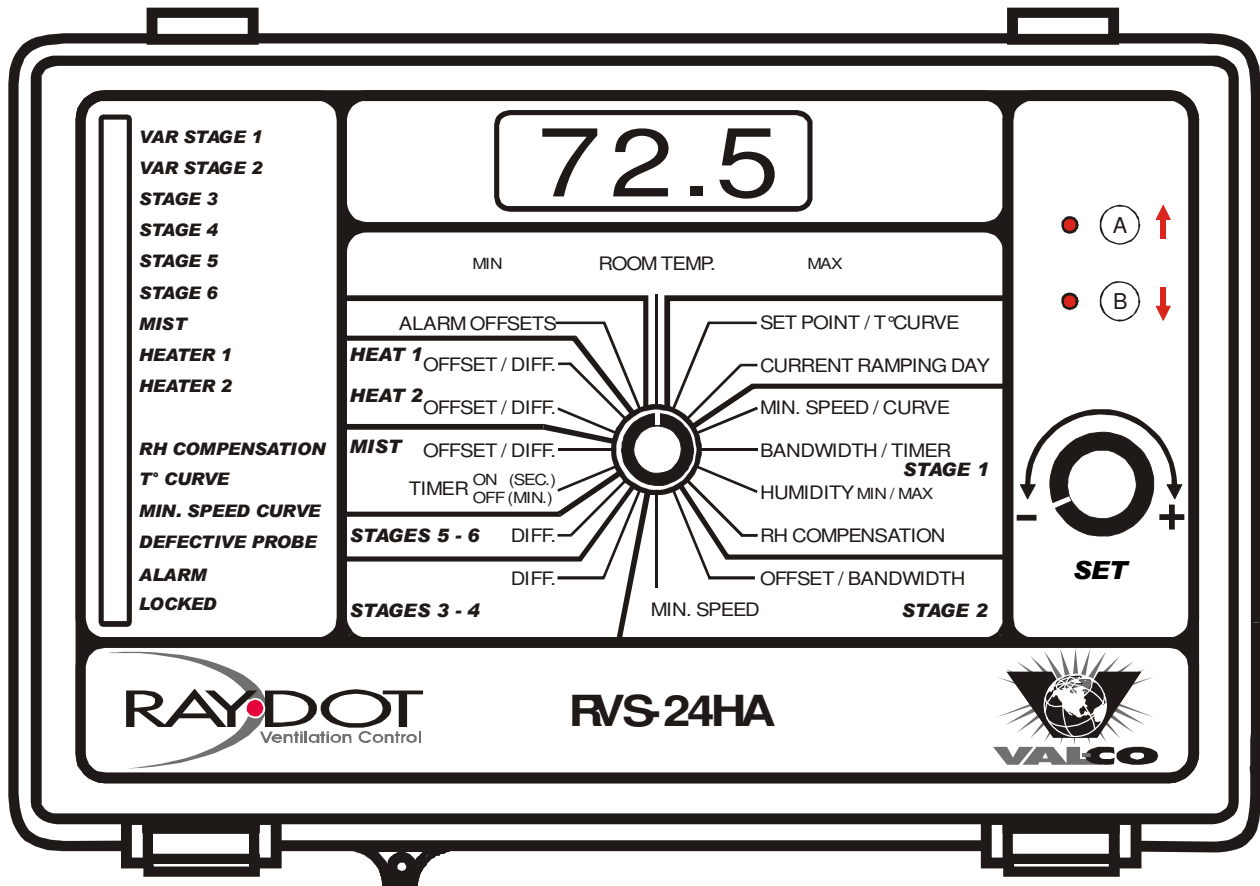

User's Guide

Read this guide carefully before using the controller.

PRECAUTIONS

We strongly recommend connecting the controller to an alarm system, and installing a supplementary natural ventilation system as well as a back-up thermostat on at least one cooling stage. Refer to the wiring diagram enclosed with this user's guide to connect the thermostat.

Input and output circuitry is protected against overload or overvoltage. However, we recommend installing an additional protection device on the supply circuit as well as an external relay on all ON-OFF stages to prolong the life of the controller.

To avoid exposing the controller to harmful gases or excessive humidity, it is preferable to install it in a corridor.

The room temperature where the controller is located **MUST ALWAYS REMAIN BETWEEN 32° AND 104°F (0° AND 40°C).**

DO NOT SPRAY WATER ON THE CONTROLLER.

FOR CUSTOMER USE

Enter below the serial number located on the side of the controller and retain this information for future reference.

Model number: RVS-24HA

Serial number: _____

TABLE OF CONTENTS

GLOSSARY	2
VENTILATION SYSTEM OVERVIEW	5
PARAMETER DESCRIPTION	6
LOCKED PARAMETERS	6
ROOM TEMPERATURE MINIMUM/MAXIMUM.....	6
SET POINT/TEMPERATURE CURVE.....	7
CURRENT RAMPING DAY	9
MINIMUM SPEED/CURVE (STAGE 1).....	9
BANDWIDTH/TIMER (STAGE 1).....	10
HUMIDITY MINIMUM/MAXIMUM (STAGE 1)	11
RELATIVE HUMIDITY COMPENSATION (STAGE 1)	12
OFFSET/BANDWIDTH (STAGE 2).....	13
MINIMUM SPEED (STAGE 2)	13
DIFFERENTIALS (STAGES 3 AND 4).....	14
DIFFERENTIALS (STAGES 5 AND 6).....	15
TIMER (MIST)	16
OFFSET/DIFFERENTIAL (MIST)	17
OFFSET/DIFFERENTIAL (HEAT 2).....	17
OFFSET/DIFFERENTIAL (HEAT 1).....	18
ALARM OFFSETS.....	19
DIP SWITCHES AND PROBES	26
MOTOR TYPES	27
TECHNICAL SPECIFICATIONS.....	28
FACTORY SETTINGS	29
WIRING DIAGRAM.....	31
NOTES.....	32

GLOSSARY

↓ or ↑

Located to the left of a parameter name, these arrows indicate that the user must either scroll up or down to access the parameter, by pressing push-button A (scroll up) or B (scroll down) found in the rightmost section of the faceplate.

Ⓐ or Ⓑ

Located to the left of a parameter name, the circled letters A or B indicate that the user accesses the parameter directly, by pressing push-button A or B found in the rightmost section of the faceplate.

Bandwidth

The bandwidth is the temperature interval within which the variable speed fans of a given stage increase or decrease in speed proportionally to the temperature.

Cascading heaters

Heaters operate in a sequence. As the average room temperature drops, additional heaters are turned on as needed.

Default value

A typical parameter setting defined at the factory.

Differential

The differential is the temperature difference between the moment the constant-speed fans or heating units of a given stage start running and the moment they return to a stop.

Hysteresis

A hysteresis is used to smooth the transition from one state to another. For example, when the temperature drops to the cut-off point for a stage of constant-speed fans, the fans will actually cut off at slightly less than the cut-off point. This way, if the temperature fluctuates around the cut-off point without dropping significantly below it, the controller will not oscillate between two states. For example, if the hysteresis is 0.3°F and the stage 2 fans are programmed to cut off at 75.0°F, the cut-off will actually occur at 74.7°F.

Messages

Messages appear in the LED display alternating with the value of the corresponding setting. Some parameter adjustments are displayed both as a relative value and an absolute temperature. This applies to all heating and cooling differentials, the mist differential and to the heater and alarm offsets. The parameter is first displayed as a relative value. The corresponding absolute temperature is displayed after 10 seconds if no action is taken by the user. The absolute value is the temperature at which the stage turns on (except in the case of the heater and mist offsets, where the value displayed is the temperature at which the stage turns off). If the user turns the adjustment knob, the relative value reappears.

Here is an example of the sequence followed by the display when the user turns the selection knob to the "STAGES 3-4 DIFF." position.

1. The current differential for stage 3 flashes on the display, alternating with "St 3".

The LED display shows two rectangular boxes. The left box contains the text "St 3" and the right box contains the text "2.0".

2. If, after approximately 10 seconds, no action is taken by the user, the absolute temperature value is displayed, alternating with "St 3". In this case, the absolute value is: **Set Point + Stage 1 Bandwidth + Stage 2 Offset + Stage 2 Bandwidth + Stage 3 Differential**.

The LED display shows two rectangular boxes. The left box contains the text "St 3" and the right box contains the text "78.0".

3. When the user turns the adjustment knob to adjust the **Stage 3 Differential**, the relative value reappears on the display.

The LED display shows a single rectangular box containing the text "2.3".

In the case of the mist and heating units, when the user adjusts the offset, the stopping temperature is displayed with the letters "STOP".

Minimum ventilation cycle

When the room temperature is below the set point, the stage 1 fans operate intermittently to provide minimum ventilation to the room.

Minimum ventilation speed curve

The user can define a minimum ventilation speed curve to adjust the stage 1 minimum speed automatically over a given time period. The minimum speed increases over time as the animals grow.

Offset

An offset is a temperature difference from the set point that normally defines a cut-off point for a stage operation. For example, a heater offset of 2.0°F means the heaters will turn off at 2.0°F above the set point.

Set point

The set point is the target room temperature. When the temperature is above the set point, the controller cools the room by turning on the cooling fans. When the temperature is below the set point, the controller heats the room by turning on the heaters.

Temperature curve

The controller can be set to automatically change the temperature set point over a given period of time in accordance with the user's requirements. The set point decreases over time as the animals grow.

Zoned heaters

When zoned heaters are used, heaters in each zone operate according to their corresponding probes rather than from the average temperature of the entire room. This way, heaters operate independently from one zone to the other. See page 26 "**DIP SWITCHES AND PROBES**" for more information on zone temperatures.

VENTILATION SYSTEM OVERVIEW

The RVS-24HA is a powerful environmental controller that can manage two variable ventilation stages and four on/off ventilation stages. The first on/off stage is a ventilation stage. Depending on user setup, the second on/off stage can either be a ventilation or a mist stage, and the last two on/off stages may be heating, mist or ventilation stages.

Cooling Operation

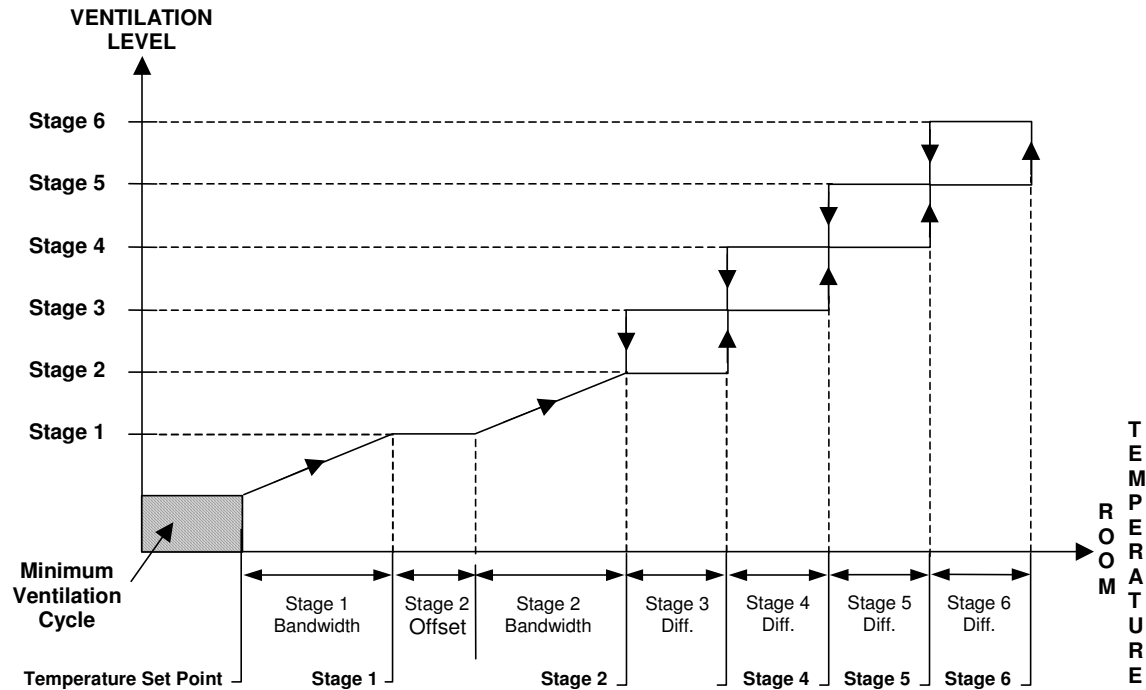

All outputs (except for alarms if “ind” is chosen at parameter **Alarm Individual/All**) are controlled by the “room temperature”, which is the temperature averaged from # 1 to 4 probe readings. Heaters follow either the room temperature or a zone temperature, depending on user setup. A humidity probe may be used to lower the humidity level by activating stage 1 or by deactivating the mist stage.

It is important to read both the RVS-24HA Installation Guide and the present User's Guide. The Installation Guide provides information on physical characteristics of the controller, mounting, connections, probes, troubleshooting and technical specifications. The User's Guide explains the workings of the controller parameters.

PARAMETER DESCRIPTION

LOCKED PARAMETERS

By setting DIP switch # 1 to the ON position, all parameters, except the **Main Set Point** and **Stage 1 Minimum Speed**, are “locked” to prevent modifications. After the user has set parameters to the desired values, he may want to lock these values for safety.

ROOM TEMPERATURE MINIMUM/MAXIMUM

Room Temperature Readout

The actual room temperature, averaged from activated interior probe readings, controls all outputs (except heaters if zoned) and alarms (except if “ind” is chosen at parameter **Alarm Individual/All**).

This parameter is displayed to the nearest 0.1°, from -6.0°F to 168.6°F (-21.1°C to 75.9°C).

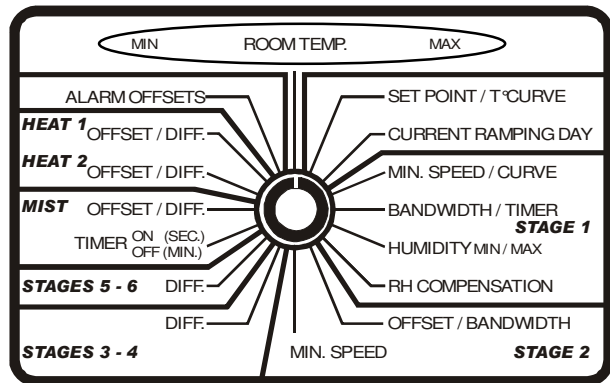

↓ Room Temperature Low (Message: “Lo”)

Continually updated, this reading shows the lowest room temperature reached since the last clear. While this setting is selected, the user may clear the **Room Temperature Low** and **High** values, along with all individual probe lows and highs, by moving the SET knob back and forth until “CLr” appears on the display. This reading is displayed to the nearest 0.1°, from -6.0°F to 168.6°F (-21.1°C to 75.9°C).

↓ Room Temperature High (Message: “Hi”)

Continually updated, this reading shows the highest room temperature reached since the last clear. While this setting is selected, the user may clear the **Room Temperature High** and **Low** values, along with all individual probe lows and highs, by moving the SET knob back and forth until “CLr” appears on the display. This reading is displayed to the nearest 0.1°, from -6.0°F to 168.6°F (-21.1°C to 75.9°C).

↓ Probe 1 (to 4) Readout (Messages: “Pr[1-4]”)

These settings display the actual temperature read by the displayed probe if that probe is activated (see the DIP switch table). These temperatures are used to calculate the **Room Temperature Readout** as well as the A and B temperature zones, used for the heaters. These readings are displayed to the nearest 0.1°, from -6.0°F to 168.6°F (-21.1°C to 75.9°C).

↓ Probe 1 (to 4) Low (Messages: “Pr[1-4]Lo”)

These readings, continually updated, display the lowest temperature read by the displayed probe since the last clear. Displayed probes must be activated to access these readings. While this setting is selected, the user may clear the **Probe [#] Low** reading, along with all

individual probe lows and highs, and along with the **Room Temperature Low and High**, by moving the SET knob back and forth until “CLr” appears on the display. These readings are displayed to the nearest 0.1°, from -6.0°F to 168.6°F (-21.1°C to 75.9°C).

↓ **Probe 1 (to 4) High** (Messages: “Pr[1-4]Hi”)

These readings, continually updated, display the highest temperature read by the displayed probe since the last clear. Displayed probes must be activated to access these readings. While this setting is selected, the user may clear the **Probe [#] High** reading, along with all individual probe lows and highs, and along with the **Room Temperature Low and High**, by moving the SET knob back and forth until “CLr” appears on the display. These readings are displayed to the nearest 0.1°, from -6.0°F to 168.6°F (-21.1°C to 75.9°C).

↓ **Test Mode** (Message: “tEst”)

The **Test Mode** allows the user to simulate a temperature reading in order to test the reaction of the control at a given temperature.

When the **Test Mode** is OFF, the control operates according to **Room Temperature Readout**.

To activate the **Test Mode**, the user must turn the SET knob back and forth until “tEst” appears on the display. This unlocks the **Test Mode**, which uses the **Room Temperature Readout** as its default simulated value. The user may then modify this value to test the control reaction to a given temperature.

To deactivate the **Test Mode**, the user must move the SET knob back and forth; “tEst” will appear alternating with “OFF” on the display. If the user does not turn a knob or a push a button for five minutes, the control will deactivate the **Test Mode** automatically.

This parameter is adjusted in 0.1° increments from OFF, -6.0°F to 168.6°F (-21.1°C to 75.9°C).

↓ **Software Version** (Message: “SoFt”)

The **Software Version** indicates which software version is currently in the controller. This parameter should always indicate 3 for this version.

SET POINT/TEMPERATURE CURVE

Set Point

This parameter is the room temperature goal and the activation point for stage 1. The **Set Point** can be adjusted in locked mode (see DIP switch table), but cannot be adjusted if the ramping day is activated. When the **Room Temperature Readout** is exactly at the **Set Point**, stage 1 is activated at **Stage 1 Minimum Speed**. This parameter may be affected by the ramping function.

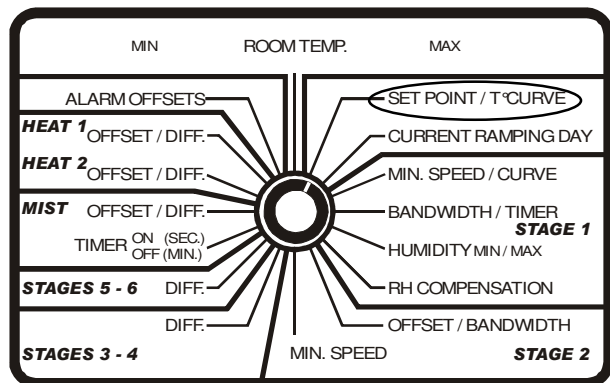

The **Set Point** is adjusted in 0.1° increments, from -40.0°F to 100.0°F (-40.0°C to 40.0°C).

A Adjust Day (Display: "d#: [value]", where # = 1 to 9, or "10: [value]")

The user can program up to 10 points on the ramping curve. Each point, which represents a day number, may be set to any value between 1 and 255.

To obtain a ramping curve having less than 10 points, first program the day numbers you require. Then program an additional day with a day number inferior to that of the last day number you require. The controller will react by leveling the temperature to the value programmed for the last day number you require on the ramping curve. See the four-point temperature curve below.

B Adjust Temperature (Display: "t#: [value]", where # = 1 to 9, or "10: [value]")

The user can program up to 10 temperatures that correspond to the day numbers programmed on the ramping curve. Temperatures are adjusted in 0.1° increments, from -40.0°F to 100.0°F (-40.0°C to 40.0°C).

Example: Ten-Point Temperature Curve

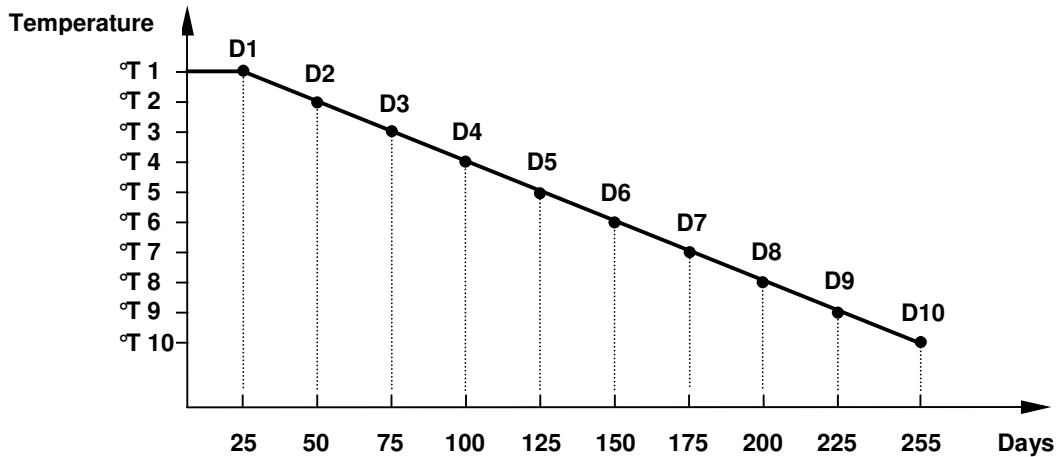

Example: Four-Point Temperature Curve

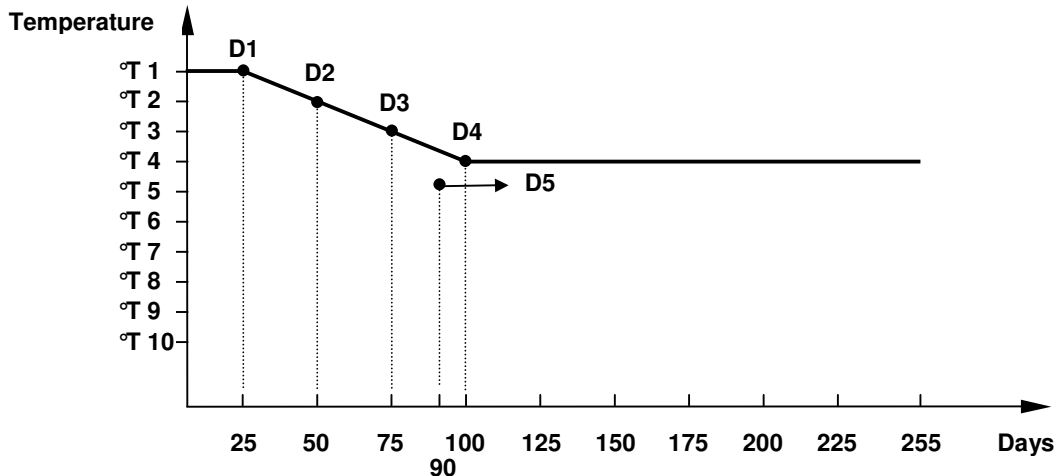

CURRENT RAMPING DAY

Current Day

All active ramping parameters will be based on the day number displayed by this setting.

The **Current Day** can be OFF or be set to any value from 1 to 255.

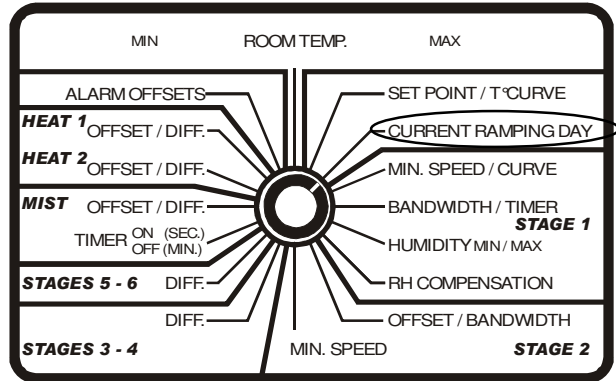

A Adjust Current Day

The **Current Day** can be turned OFF, deactivating all ramping curve functions, or adjusted to any day number from 1 to 255.

MINIMUM SPEED/CURVE (STAGE 1)

Minimum Speed

Stage 1 can never be activated at a speed lower than **Stage 1 Minimum Speed**. This parameter, one of only two adjustable parameters in locked mode, may be affected by the ramping function.

Stage 1 Minimum Speed is adjusted in 1% increments from 12% to 100%.

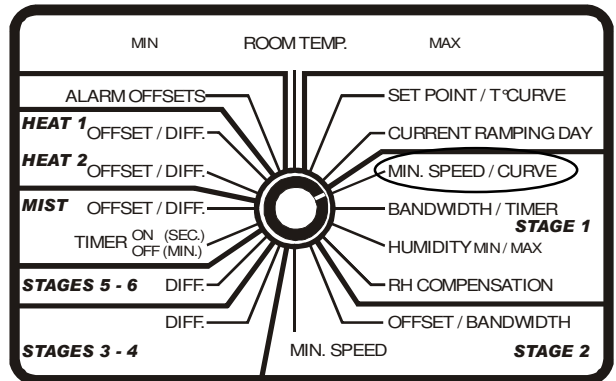

A Adjust Day (Display: “d#: [value]”, where # = 1 to 9, or “10: [value]”)

The user can program up to 10 points, each corresponding to a day, on the ramping curve. To deactivate the ramping function for **Stage 1 Minimum Speed**, the user must set the first point to OFF. Each day may be set at any value between 1 and 255.

B Adjust Minimum Speed (Display: “S#: [value]”, where # = 1 to 9, or “10: [value]”)

The user can program up to 10 minimum speeds that correspond to day numbers on the ramping curve. These values are adjusted in 1% increments from 12% to 100%.

Example: Minimum Speed Curve

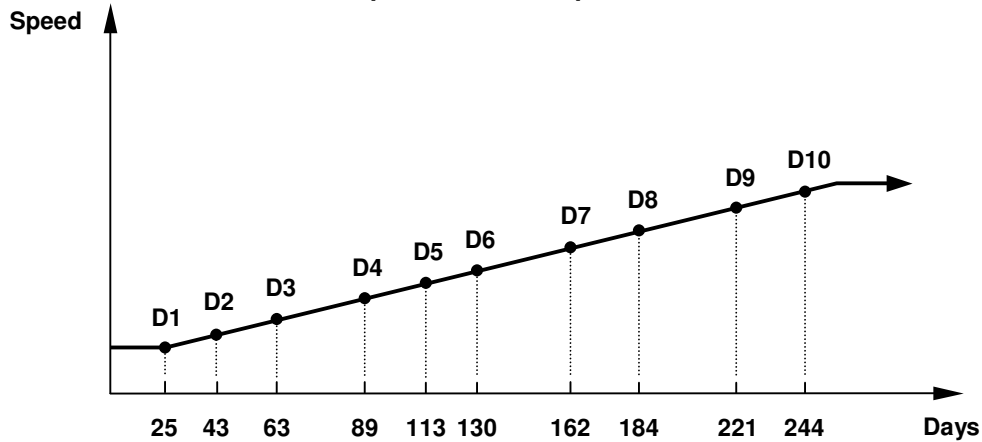

BANDWIDTH/TIMER (STAGE 1)

Bandwidth (Message: "bd")

The stage 1 bandwidth is the temperature range within which stage 1 accelerates from **Stage 1 Minimum Speed** to its maximum speed (100%). When the **Room Temperature Readout** reaches the **Set Point**, stage 1 operates continuously at minimum speed. As the **Room Temperature Readout** increases, stage 1 speeds up until **Set Point + Stage 1 Bandwidth** is reached, at which point stage 1 operates at 100%.

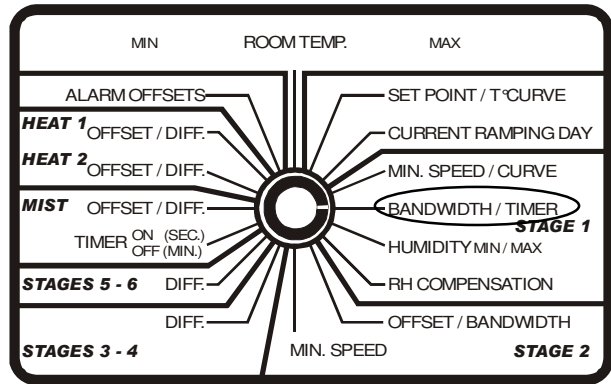

This parameter is adjusted in 0.1° increments, from 0.5°F to 20.0°F (0.3°C to 11.0°C).

↓ Minimum Ventilation On Time (Message: "On")

This parameter adjusts the time during which the minimum ventilation timer is on. When the **Room Temperature Readout** is below the **Set Point**, stage 1 is activated at **Stage 1 Minimum Speed** during the time specified for this parameter, and is deactivated for **Minimum Ventilation Off Time**. To deactivate minimum ventilation, simply set this parameter to 0. **Minimum Ventilation On Time** is adjusted in 15-second increments, from 0 to 900 seconds.

↓ Minimum Ventilation Off Time (Message: "OFF")

When the **Room Temperature Readout** is below the **Set Point**, the control is in minimum ventilation. During minimum ventilation, stage 1 is activated at **Stage 1 Minimum Speed** during **Minimum Ventilation On Time** and deactivated during the time specified for this parameter. To have stage 1 operate continuously at **Stage 1 Minimum Speed** when in minimum ventilation, simply adjust this parameter to 0. **Minimum Ventilation Off Time** is adjusted in 15-second increments, from 0 to 900 seconds.

Minimum Ventilation Cycle

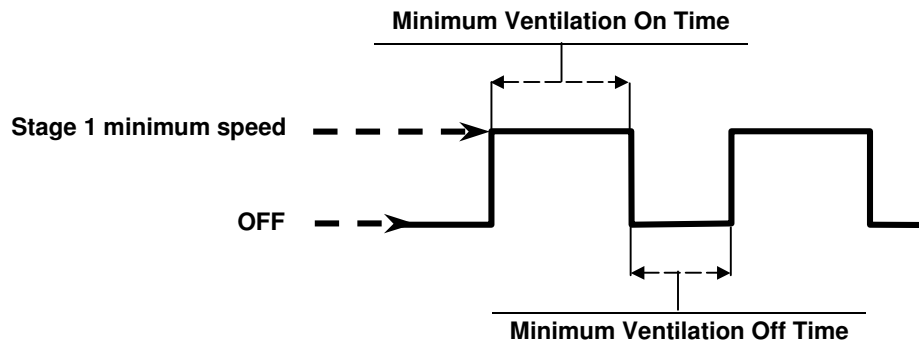

↓ **Motor Type** (Message: “tyP”)

This parameter allows the user to choose the motor type for stage 1. The right motor type ensures correct supply voltage at a given speed. Refer to the motor type table for the list of available motor types.

HUMIDITY MINIMUM/MAXIMUM (STAGE 1)

Readout (Message: “rH”)

This parameter displays the actual relative humidity. **Humidity** can affect stage 1 and mist stage behaviors.

The humidity probe is optional. When there is no humidity probe, dehumidification and mist shut off logics are deactivated. To learn more about deactivating the humidity logic, read the **Compensation Option** parameter description below.

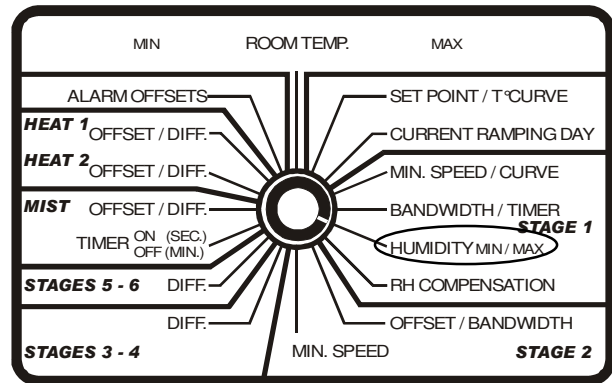

This parameter is displayed to the nearest 1 RH% from 10 RH% to 90 RH%.

↓ **Humidity Low** (Message: “rH Lo”)

Continually updated, this reading shows the lowest humidity read by the probe since the last clear. While this setting is selected, the user may clear the **Humidity Low** and **High** values by moving the SET knob back and forth until “CLr” appears on the display. This reading is displayed in 1 RH% increments, from 10 RH% to 90 RH%.

↓ **Humidity High** (Message: “rH Hi”)

Continually updated, this reading shows the highest humidity read by the probe since the last clear. While this setting is selected, the user may clear the **Humidity Low** and **High** values by moving the SET knob back and forth until “CLr” appears on the display. This reading is displayed in 1 RH% increments, from 10 RH% to 90 RH%.

RELATIVE HUMIDITY COMPENSATION (STAGE 1)

Compensation Option (Message: "OPT")

This parameter activates or deactivates all humidity logic. Setting this parameter to OFF eliminates the **Relative Humidity Speed Compensation** logic as well as the **Humidity Turn Off** mist logic. This parameter can be set to OFF or ON.

For more details on humidity logic, read the **Relative Humidity Speed Compensation** parameter description below.

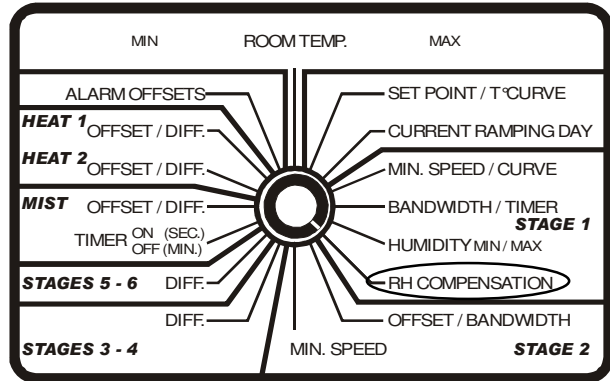

Ex.: **Compensation Option** = ON
Stage 1 Minimum Speed = 20%
Humidity Set Point = 70 RH%
Relative Humidity Speed Compensation = 50%

Humidity Speed Compensation

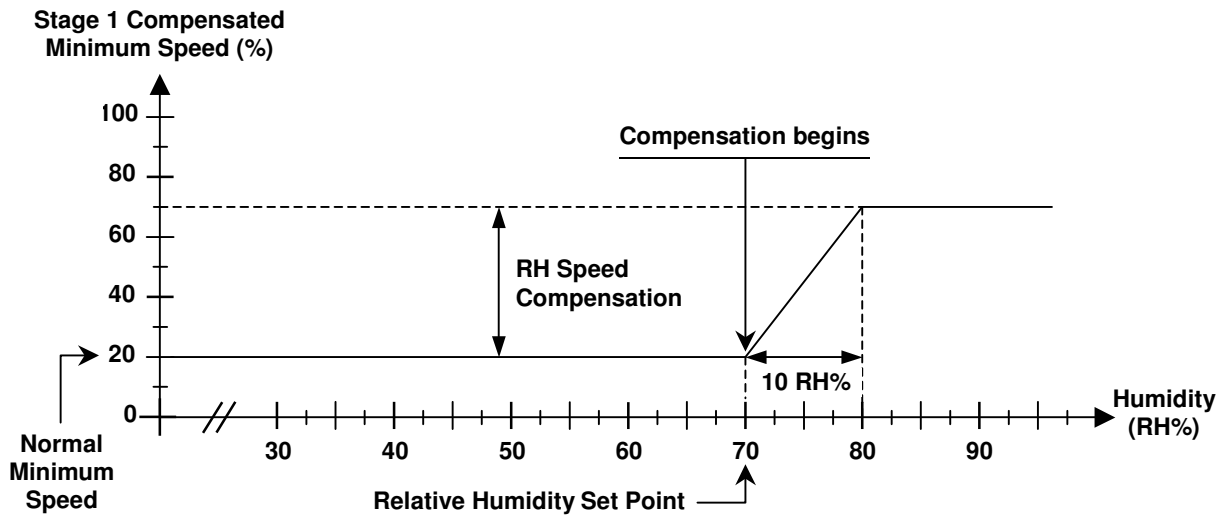

↓ Humidity Set Point (Message: "rH SP")

This parameter, visible if the **Compensation Option** parameter is set to ON, represents the humidity level to reach before dehumidification can start. If stage 1 is not activated and **Humidity** reaches **Humidity Set Point**, stage 1 operates at **Stage 1 Minimum Speed** regardless of the minimum ventilation timer. Stage 1 accelerates as **Humidity** increases, to reach **Stage 1 Minimum Speed + Relative Humidity Speed Compensation** when **Humidity** reaches **Humidity Set Point + 10 RH%**. If stage 1 is already activated, its minimum speed will be adjusted in the same manner. Stage 1 modulates from the compensated minimum speed to 100% according to the **Room Temperature Readout**. This parameter is adjusted in 1 RH% increments, from 10 RH% to 90 RH%. The previous parameter description provides an example.

↓ **Relative Humidity Speed Compensation** (Message: "SPd")

This parameter, visible if the **Compensation Option** parameter is set to ON, is used to adjust stage 1's speed compensation for dehumidification. Stage 1's speed will increase by this amount when **Humidity** reaches **Humidity Set Point** + 10 RH%. Setting this parameter to 0% does not affect stage 1's speed when it is already activated by temperature demand, but activates stage 1 continuously at **Stage 1 Minimum Speed** when the **Room Temperature Readout** is below the **Set Point** and **Humidity** is at or above **Humidity Set Point**. This parameter is adjusted in 1% increments, from 0% to 100%.

OFFSET/BANDWIDTH (STAGE 2)

Offset

(Message: "OFt"; absolute message: "St 2")

This parameter sets the offset for stage 2. The offset for stage 2 is the difference between the end of stage 1's modulation band and the activation point for stage 2. When the **Room Temperature Readout** reaches **Set Point** + **Stage 1 Bandwidth** + **Stage 2 Offset**, stage 2 is activated at **Stage 2 Minimum Speed**. Stage 2 will be deactivated when the **Room Temperature Readout** drops to **Set Point** + **Stage 1 Bandwidth** + **Stage 2 Offset** - 0.3°F (0.2°C). This parameter is adjusted in 0.1° increments, from 0.5°F to 20.0°F (0.3°C to 11.0°C).

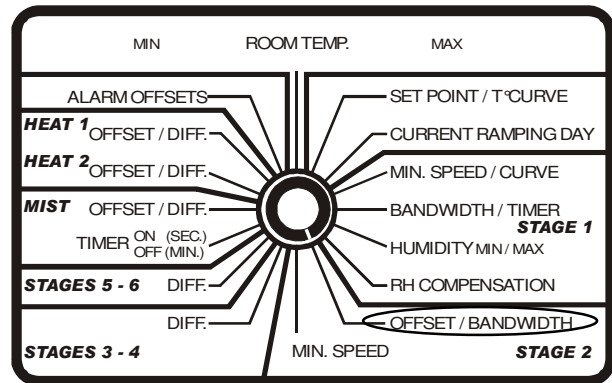

↓ **Bandwidth** (Message: "bd")

This bandwidth is the temperature range within which stage 2 accelerates from **Stage 2 Minimum Speed** to its maximum speed (100%). When the **Room Temperature Readout** reaches the **Set Point** + **Stage 1 Bandwidth** + **Stage 2 Offset**, stage 2 operates continuously at minimum speed. As the **Room Temperature Readout** increases, stage 2 speeds up until **Set Point** + **Stage 1 Bandwidth** + **Stage 2 Offset** + **Stage 2 Bandwidth** is reached. At this point, stage 2 operates at 100%. This parameter is adjusted in 0.1° increments, from 0.5°F to 20.0°F (0.3°C to 11.0°C).

MINIMUM SPEED (STAGE 2)

Minimum Speed

(Message: "SPd")

Stage 2 will never operate at a speed lower than this speed, its minimum speed.

Stage 2 Minimum Speed is adjusted in 1% increments, from 12% to 100%.

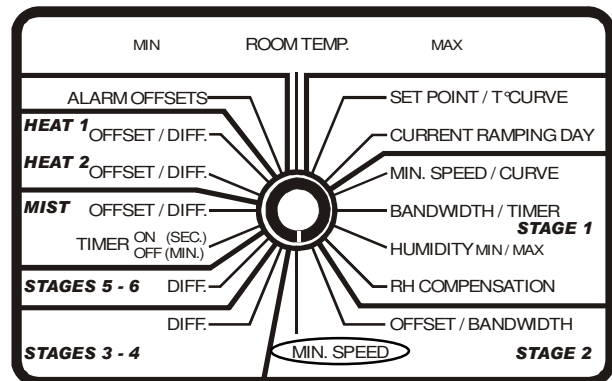

↓ **De-Icing Cycle Time** (Message: "Cyc")

This parameter, visible if DIP switch # 11 (de-icing option) is set to ON, establishes the length of time during which stage 2 de-icing is inactive. If stage 2 stays deactivated for a longer period of time than **De-Icing Cycle Time**, stage 2 is activated at minimum speed for **De-Icing On Time**. This parameter is adjusted in 1-minute increments, from 1 to 720 minutes.

↓ **De-Icing On Time** (Message: "On")

This parameter, visible if DIP switch # 11 (de-icing option) is set to ON, establishes the length of time during which stage 2 de-icing is active. During de-icing, stage 1 becomes deactivated during the time specified in the present parameter. If stage 2 stays deactivated for more than **De-Icing Cycle Time**, stage 2 is activated at minimum speed for **De-Icing On Time**. This parameter is adjusted in 1-second increments, from 0 to 900 seconds.

↓ **Motor Type** (Message: "tyP")

This parameter allows the user to choose the motor type for stage 2. The right motor type ensures correct supply voltage at a given speed. Refer to the motor type table for the list of available motor types.

DIFFERENTIALS (STAGES 3 AND 4)

Stage 3 Differential

(Message: "St 3"; absolute message: "St 3")

This setting adjusts the temperature at which stage 3 is activated.

When the **Room Temperature Readout** reaches **Set Point + Stage 1 Bandwidth + Stage 2 Offset + Stage 2 Bandwidth + Stage 3 Differential**, stage 3 is activated.

This parameter is adjusted in 0.1° increments, from 0.5°F to 20.0°F (0.3°C to 11.0°C).

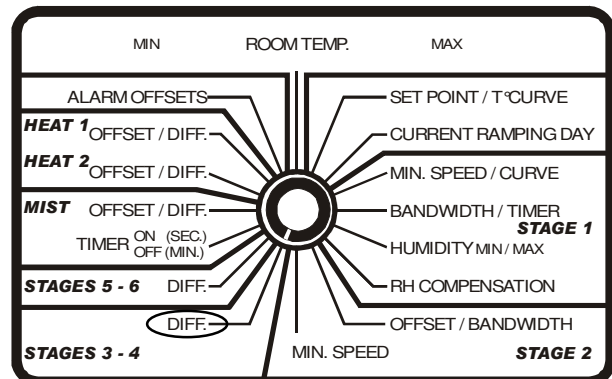

↓ **Stage 4 Differential** (Message: "St 4"; absolute message: "St 4")

This parameter is invisible if DIP switches # 6 (heating), # 7 (2 heating stages) and # 9 (mist on) are all set to ON. This setting adjusts the temperature at which stage 4 is activated. When the **Room Temperature Readout** reaches **Set Point + Stage 1 Bandwidth + Stage 2 Offset + Stage 2 Bandwidth + Stage 3 Differential + Stage 4 Differential**, stage 4 is activated. This parameter is adjusted in 0.1° increments, from 0.5°F to 20.0°F (0.3°C to 11.0°C).

Using a Fixed Offset on on/off Stages*

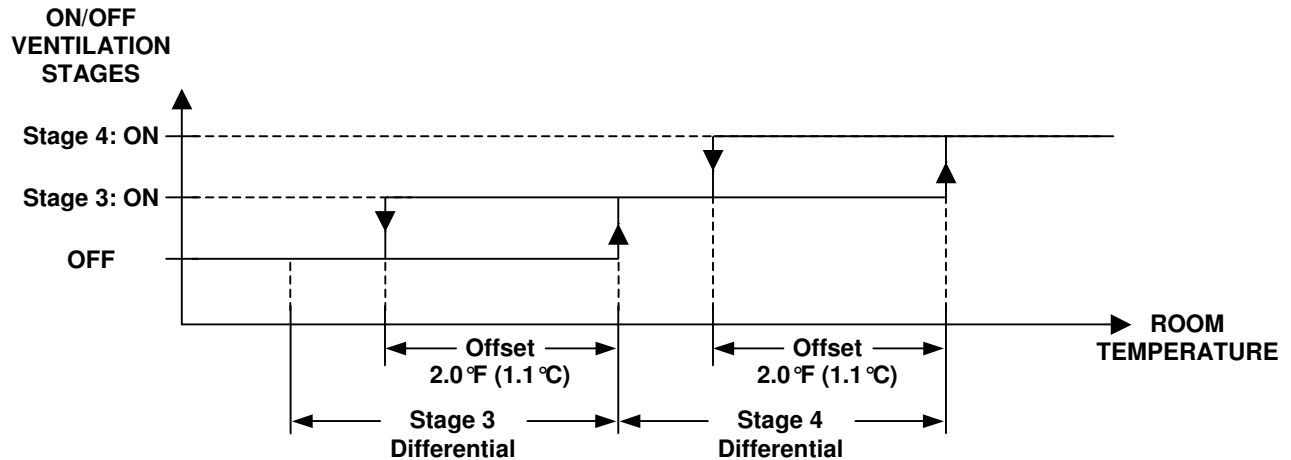

DIFFERENTIALS (STAGES 5 AND 6)

Stage 5 Differential

(Message: "St 5"; absolute message: "St 5")

This setting adjusts the temperature at which stage 5 is activated.

This parameter is accessible only if DIP switch # 6 (no heating) is set to OFF, or if DIP switches # 7 (1 heating stage) and # 9 (mist off) are both set to OFF.

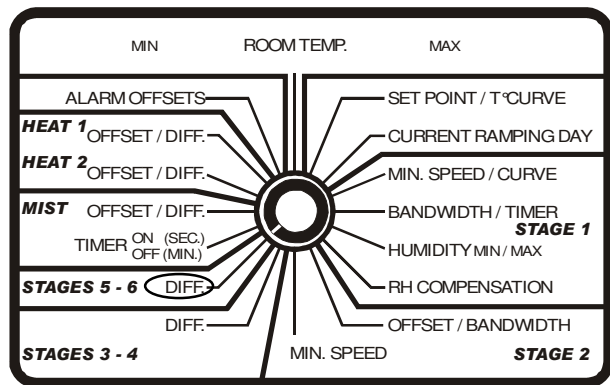

When the **Room Temperature Readout** reaches **Set Point + Stage 1 Bandwidth + Stage 2 Offset + Stage 2 Bandwidth + Stage 3 Differential + Stage 4 Differential + Stage 5 Differential**, stage 5 is activated.

This parameter is adjusted in 0.1° increments, from 0.5°F to 20.0°F (0.3°C to 11.0°C).

↓ **Stage 6 Differential** (Message: "St 6"; absolute message: "St 6")

This setting adjusts the temperature at which stage 6 is activated.

This parameter is invisible if DIP switch # 6 (no heating) and # 9 (mist on) are both set to OFF.

When the **Room Temperature Readout** reaches **Set Point + Stage 1 Bandwidth + Stage 2 Offset + Stage 2 Bandwidth + Stage 3 Differential + Stage 4 Differential + Stage 5 Differential + Stage 6 Differential**, stage 6 is activated. This parameter is adjusted in 0.1° increments, from 0.5°F to 20.0°F (0.3°C to 11.0°C).

* This example, with DIP switch # 10 in the ON position, applies not only to stages 3 and 4, but also to all on/off ventilation stages. If DIP # 10 switch is in the OFF position, the logic that applies is illustrated by the diagram found in the Ventilation System Overview section.

TIMER (MIST)

Mist On Time (Message: "On")

This parameter is accessible if DIP switch # 9 is set to ON (mist stage enabled). Refer to the DIP switch table in the last pages of this document.

This parameter adjusts the mist timer ON time. When the temperature is above **Set Point + Mist Offset + Mist Differential**, the mist is activated on a timer. The mist is activated during this period of time and then deactivated for **Mist Off Time**.

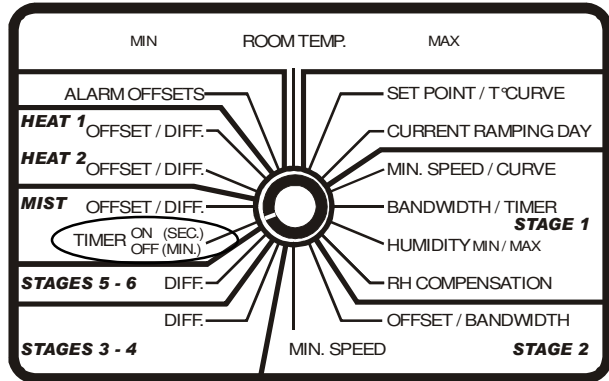

To deactivate the mist stage, simply adjust the setting to 0. **Mist On Time** is adjusted in 15-second increments, from 0 to 900 seconds.

↓ Mist Off Time (Message: "OFF")

This parameter, visible if DIP switch # 9 is set to ON (mist stage enabled), adjusts the mist timer OFF time. When the temperature is above **Set Point + Mist Offset + Mist Differential**, the mist is activated on a timer. If **Mist Off Time** is set to 0, the mist output is not affected by **Humidity** and runs continuously like a fan. The mist is deactivated during this period of time and then activated for **Mist On Time**. **Mist Off Time** is adjusted in 1-minute increments, from 0 to 20 minutes.

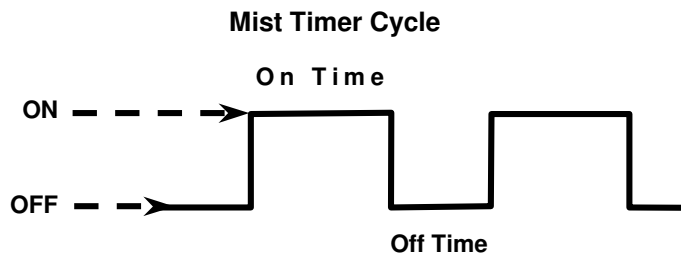
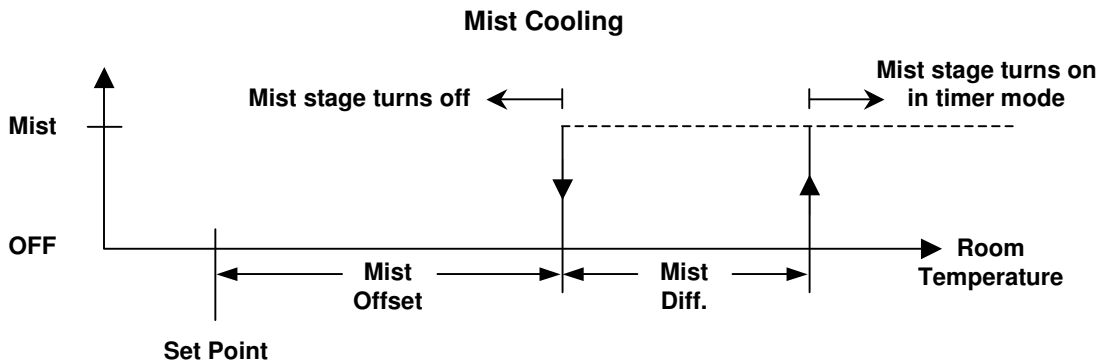

OFFSET/DIFFERENTIAL (MIST)

Offset

(Message: "OFt"; absolute message: "StOP")

This parameter sets the temperature at which mist stage is deactivated. The mist is deactivated when the **Room Temperature Readout** drops to **Set Point + Mist Offset**.

This parameter is adjusted in 0.1° increments, from 0.5°F to 20.0°F (0.3°C to 11.0°C).

This parameter is accessible if DIP switch # 9 is set to ON (mist stage enabled).

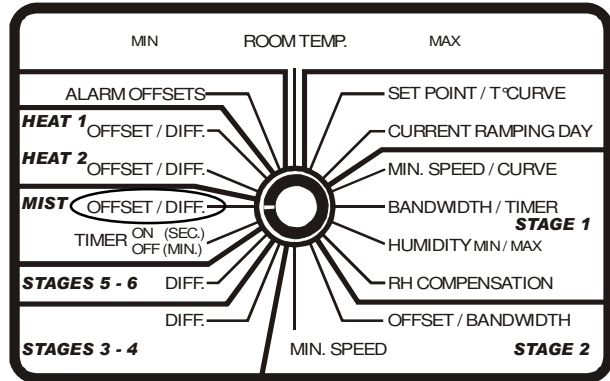

↓ Differential (Message: "diFF")

This parameter, visible if DIP switch # 9 is set to ON (mist stage enabled), sets the temperature at which mist stage is activated. When the **Room Temperature Readout** reaches **Set Point + Mist Offset + Mist Differential**, the mist is activated according to its timer. This parameter is adjusted in 0.1° increments, from 0.5°F to 20.0°F (0.3°C to 11.0°C).

↓ Humidity Turn Off (Message: "rHOFF")

This parameter is visible if DIP switch # 9 is set to ON (mist stage enabled), if the **Compensation Option** parameter is ON, and if **Mist Off Time** is set to a different value than 0.

This parameter sets the humidity level at which the mist stage shuts off. When the mist stage is enabled and **Humidity** reaches **Mist Humidity Turn Off**, the mist is not able to operate or stops operating if already on. This parameter may be set to OFF to prevent the mist stage from becoming deactivated even when the humidity level is very high. This parameter is adjusted in 1 RH% increments, from 40 RH% to 90 RH%, OFF.

OFFSET/DIFFERENTIAL (HEAT 2)

Heater 2 Offset

(Message: "OFt"; absolute message: "StOP")

This parameter, visible if DIP switches # 6 (heating enabled) and # 7 (2 heating stages) are set to ON, determines the temperature at which heater 2 is deactivated.

If DIP switch # 8 (zoned or cascading heaters) is set to OFF, heater 2 is controlled by the **Room Temperature Readout**. If DIP switch # 8 is set to ON, heater 2 is controlled by the zone B temperature reading.

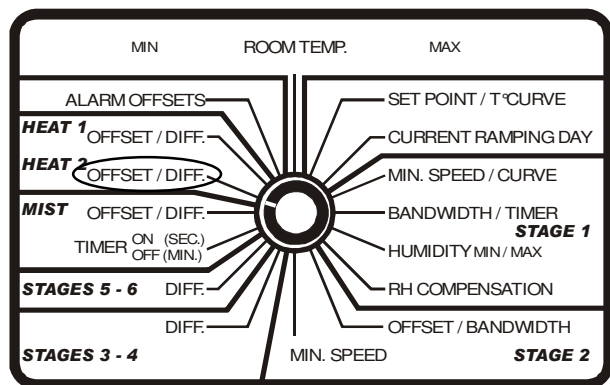

Heater 2 is deactivated either when the zone B temperature reading rises to **Set Point – Heater 2 Offset**, with DIP switch # 8 in the ON position, or when the **Room Temperature Readout**

rises to **Set Point – Heater 1 Offset – Heater 1 Differential**, with DIP switch # 8 in the OFF position.

This parameter is adjusted in 0.1° increments, from -10.0°F to 20.0°F (-5.5°C to 11.0°C).

↓ **Heater 2 Differential** (Message: “diFF”)

This parameter, visible if DIP switches # 6 (heating enabled) and # 7 (2 heating stages) are set to ON, determines the activation point for heater 2. Heater 2 is activated when the zone B temperature reading reaches **Set Point – Heater 2 Offset – Heater 2 Differential** with DIP switch # 8 in the ON position, or when the **Room Temperature Readout** reaches **Set Point – Heater 1 Offset – Heater 1 Differential – Heater 2 differential**, with DIP switch # 8 in the OFF position. This parameter is adjusted in 0.1° increments, from 0.5°F to 20.0°F (0.3°C to 11.0°C).

↓ **Maximum Difference Protection between Zones** (Message: “dProt”)

This parameter, visible if DIP switches # 6 (heating enabled), # 7 (2 heating stages) and # 8 (zoned heating) are set to ON, defines the maximum difference allowed between zone A and zone B for desired heater operation. When the difference between these two zones exceeds this parameter, all cooling stages follow the highest zone temperature. Setting this parameter to OFF means that cooling stages follow the **Room Temperature Readout** at all times.

This parameter is adjusted in 0.1° increments, from 5.0°F to 40.0°F (3.0°C to 22.0°C), OFF.

See page 26 “**DIP SWITCHES AND PROBES**” for more information on zone temperatures.

OFFSET/DIFFERENTIAL (HEAT 1)

Heater 1 Offset

(Message: “OFt”; absolute message: “StOP”)

This parameter, visible if DIP switch # 6 is set to ON (heating enabled), determines the temperature at which heater 1 is deactivated.

If DIP switch # 8 (zoned or cascading heaters) is set to OFF, heater 1 is controlled by the **Room Temperature Readout**. If DIP switch # 8 is set to ON, heater 1 is controlled by the zone A temperature reading.

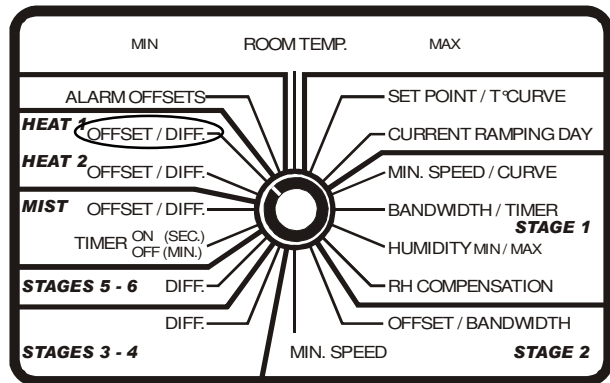

Heater 1 is deactivated when the **Room Temperature Readout** or the zone A temperature reading rises to **Set Point – Heater 1 Offset**.

This parameter is adjusted in 0.1° increments, from -10.0°F to 20.0°F (-5.5°C to 11.0°C).

↓ **Heater 1 Differential** (Message: "diFF")

This parameter, visible if DIP switch # 6 is set to ON (heating enabled), determines the activation point for heater 1. Heater 1 is activated when the **Room Temperature Readout** or the zone A temperature reading reaches **Set Point – Heater 1 Offset – Heater 1 Differential**. This parameter is adjusted in 0.1° increments, from 0.5°F to 20.0°F (0.3°C to 11.0°C).

Zoned Heater Operation

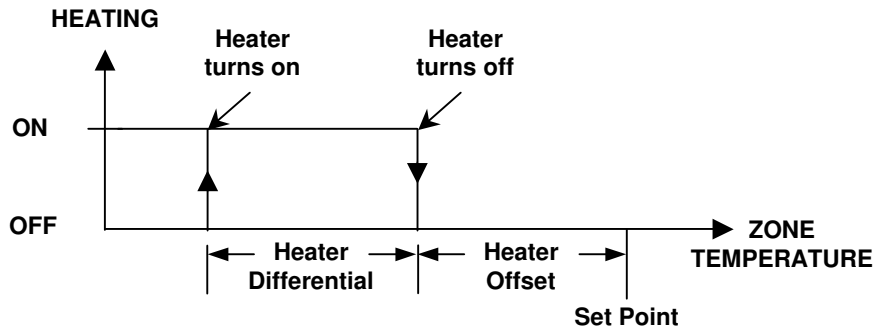

Cascading Heaters Operation

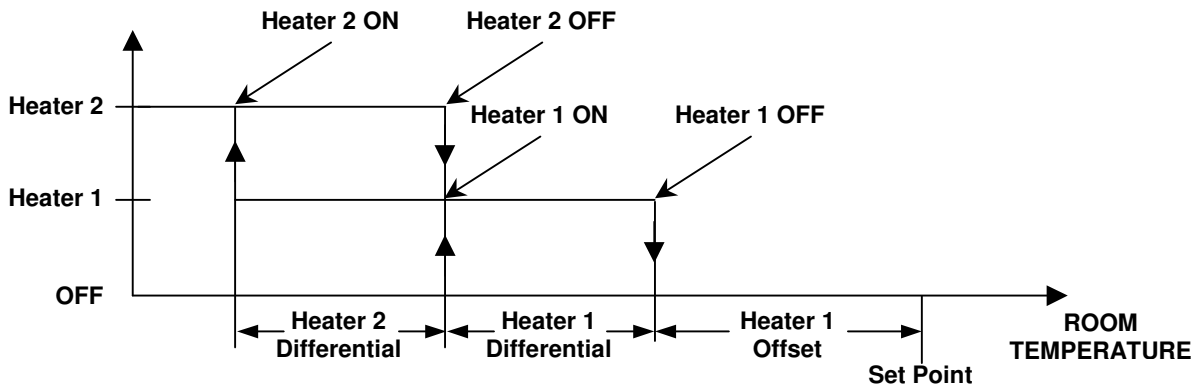

ALARM OFFSETS

Low Alarm Offset

(Message: "Lo"; absolute message: "Lo")

This parameter determines the temperature at which occurs a low alarm condition.

When the temperature* is lower than **Set Point – Low Alarm Offset**, the alarm sets off.

This parameter is adjusted in 0.1° increments, from 0.5°F to 40.0°F (0.3°C to 20.0°C).

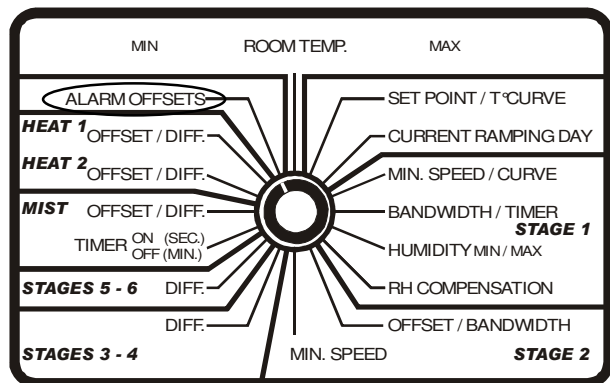

The alarm is normally activated, but will be deactivated 13 seconds or more after one of the following events:

1. The RVS-24HA loses its power;
2. The temperature* is lower than **Low Alarm Offset**;
3. The temperature* is higher than **High Alarm Offset**;
4. The temperature* is higher than the **Critical High Alarm** parameter;
5. An active temperature probe is defective (disconnected, open circuit, short-circuited).

↓ **High Alarm Offset** (Message: “Hi”; absolute message: “Hi”)

This parameter determines the temperature at which occurs a high alarm condition. When the temperature* is higher than **Set Point + High Alarm Offset**, the alarm sets off.

This parameter is adjusted in 0.1° increments, from 0.5°F to 40.0°F (0.3°C to 22.0°C).

↓ **Critical High Alarm** (Message: “Cri”)

This parameter determines the temperature at which occurs a critical high alarm condition. When the temperature* is higher than **Critical High Alarm**, the alarm sets off.

This parameter is adjusted in 0.1° increments, from -40.0°F to 120.0°F (-40.0°C to 50.0°C).

↓ **Alarm Individual/All** (Message: “AL”)

This parameter allows the user to choose the temperature alarm condition. If set to “ALL”, a temperature alarm will only set off when the average reading of all probes (the value displayed in the **Room Temperature Readout** parameter) is out of the alarm offset range. If set to “ind”, the alarm sets off as soon as any individual probe is out of the alarm offset range.

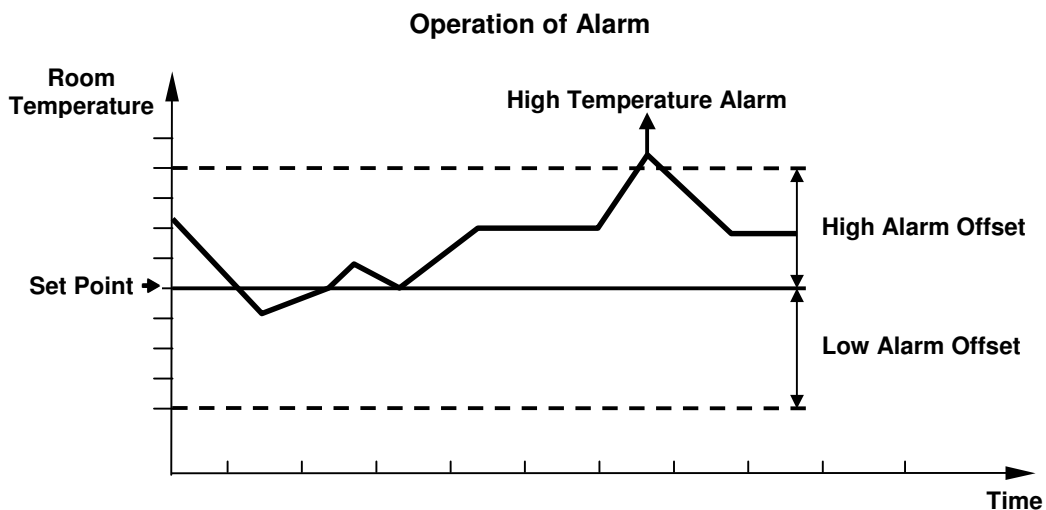

↓ **Inlet 1** (Message: “In 1”)

This setting allows the user to activate or deactivate Inlet 1. If this parameter is set to ON, all inlet 1 settings and the **Inlet 2** option will become visible and inlet 1 will position itself

according to stage activation or temperature. If set to OFF, those settings will not appear and inlet 1 will receive a constant close signal.

↓ **Inlet 1 Step 0** (Message: "1 S0")

This setting, visible if **Inlet 1** is set to ON, defines the position inlet 1 will take when temperature is below the **Set Point**. Inlet will never be opened less than this value unless it is completely deactivated using the **Inlet 1** option. As temperature nears the **Set Point** (**Set Point** – 0.4°F or **Set Point** – 0.2°C), inlet's opening will start to increase as temperature rises to reach **Inlet 1 Step 1 Lo** when temperature is exactly at the **Set Point**. The position of inlet 1 will be greater than temperature would require when stage 1 is activated for minimum ventilation or humidity compensation. This parameter is adjusted in 1% increments, from 0% to 100%.

↓ **Inlet 1 Step 1 Lo** (Message: "1 S1L")

This setting, visible if **Inlet 1** is set to ON, defines the position inlet 1 will take when stage 1 is activated at its minimum speed. Inlet opening will increase as stage 1's speed increases to reach **Inlet 1 Step 1 Hi** when stage 1 is running at full speed. This parameter is adjusted in 1% increments, from 0% to 100%.

↓ **Inlet 1 Step 1 Hi** (Message: "1 S1H")

This setting, visible if **Inlet 1** is set to ON, defines the position inlet 1 will take when stage 1 is activated at full speed. Inlet opening will increase as temperature rises to reach **Inlet 1 Step 2 Lo** when stage 2 is activated at minimum speed. This parameter is adjusted in 1% increments, from 0% to 100%.

↓ **Inlet 1 Step 2 Lo** (Message: "1 S2L")

This setting, visible if **Inlet 1** is set to ON, defines the position inlet 1 will take when stage 2 is activated at its minimum speed. Inlet opening will increase as stage 2's speed increases to reach **Inlet 1 Step 2 Hi** when stage 2 is running at full speed. Inlet will **not** take this position during de-icing. This parameter is adjusted in 1% increments, from 0% to 100%.

↓ **Inlet 1 Step 2 Hi** (Message: "1 S2H")

This setting, visible if **Inlet 1** is set to ON, defines the position inlet 1 will take when stage 2 is activated at full speed. This parameter is adjusted in 1% increments, from 0% to 100%.

↓ **Inlet 1 Step 3** (Message: "1 S3")

This setting, visible if **Inlet 1** is set to ON, defines the position inlet 1 will take when stage 3 is activated. This parameter is adjusted in 1% increments, from 0% to 100%.

↓ **Inlet 1 Step 4** (Message: "1 S4")

This setting, visible if **Inlet 1** is set to ON and stage 4 is used as a ventilation stage (DIP switches # 5, 6 or 9, are set to OFF), defines the position inlet 1 will take when stage 4 is activated. This parameter is adjusted in 1% increments, from 0% to 100%.

↓ **Inlet 1 Step 5** (Message: "1 S5")

This setting, visible if **Inlet 1** is set to ON and stage 5 is used as a ventilation stage (DIP switches # 6 and 9, or DIP switch #5, are set to OFF), defines the position inlet 1 will take when stage 5 is activated. This parameter is adjusted in 1% increments, from 0% to 100%.

↓ **Inlet 1 Step 6** (Message: "1 S6")

This setting, visible if **Inlet 1** is set to ON and stage 6 is used as a ventilation stage (DIP switches # 5 and 9, are set to OFF), defines the position inlet 1 will take when stage 6 is activated. This parameter is adjusted in 1% increments, from 0% to 100%.

↓ **Inlet 1 Over Open** (Message: "1 Oop")

This setting, visible if **Inlet 1** is set to ON, determines the position inlet 1 will take when temperature is equal to or higher than the last ventilation stage's activation point + **Inlet 1 Over Bandwidth**. This parameter is adjusted in 1% increments, from 0% to 100%.

↓ **Inlet 1 Over Bandwidth** (Message: "1 Obd")

This parameter, visible if **Inlet 1** is set to ON, sets the temperature at which inlet 1 opening will be equal to **Inlet 1 Over Open**. When temperature is higher than the last ventilation stage's activation point, inlet 1 has two possible behaviors depending on the **Inlet 1 Drop** option. It will either increase its opening progressively throughout this bandwidth or maintain its position until temperature reaches the last ventilation stage's activation point + **Inlet 1 Over Bandwidth**. In both cases, inlet 1 will open at **Inlet 1 Over Open** when temperature reaches the last ventilation stage's activation point + **Inlet 1 Over Bandwidth**. In the latter case, a differential of 0.5°F (0.3°C) will be used to determine at which temperature inlet 1 will return to its previous position (**Inlet 1 Step 3**, **Inlet 1 Step 4**, **Inlet 1 Step 5** or **Inlet 1 Step 6**). This parameter is adjusted in 0.1° increments, from 0.5°F to 20.0°F (0.3°C to 11.0°C).

↓ **Inlet 1 Drop** (Message: "1 drp")

This parameter, visible if **Inlet 1** is set to ON, determines inlet 1 behavior when temperature is above the last ventilation stage's activation point. If this option is set to ON, inlet 1 will maintain its position until temperature reaches the last ventilation stage's activation point + **Inlet 1 Over Bandwidth**, at which point it will open at **Inlet 1 Over Open**. A fixed differential of 0.5° will be used on this logic. If this option is set to OFF, inlet 1 will increase its opening progressively throughout this **Inlet 1 Over Bandwidth** to reach **Inlet 1 Over Open** at the end of this same bandwidth.

↓ **Inlet 2** (Message: "In 2")

This setting, visible if **Inlet 1** is set to ON, allows the user to activate or deactivate Inlet 2. If this parameter is set to ON, all inlet 2 settings will become visible and inlet 2 will position itself according to stage activation or temperature. If set to OFF, those settings will not appear and inlet 2 will receive a constant close signal.

↓ **Inlet 2 Step 0** (Message: "2 S0")

This setting, visible if **Inlet 1** and **Inlet 2** are set to ON, defines the position inlet 2 will take when temperature is below the **Set Point**. Inlet will never be opened less than this value unless it is completely deactivated using the **Inlet 2** option. As temperature nears the **Set**

Point (Set Point – 0.4°F or Set Point – 0.2°C), inlet's opening will start to increase as temperature rises to reach **Inlet 2 Step 1 Lo** when temperature is exactly at the **Set Point**. The position of inlet 2 will be greater than temperature would require when stage 1 is activated for minimum ventilation or humidity compensation. This parameter is adjusted in 1% increments, from 0% to 100%.

↓ **Inlet 2 Step 1 Lo** (Message: "2 S1L")

This setting, visible if **Inlet 1** and **Inlet 2** are set to ON, defines the position inlet 2 will take when stage 1 is activated at its minimum speed. Inlet opening will increase as stage 1's speed increases to reach **Inlet 2 Step 1 Hi** when stage 1 is running at full speed. This parameter is adjusted in 1% increments, from 0% to 100%.

↓ **Inlet 2 Step 1 Hi** (Message: "2 S1H")

This setting, visible if **Inlet 1** and **Inlet 2** are set to ON, defines the position inlet 2 will take when stage 1 is activated at full speed. Inlet opening will increase as temperature rises to reach **Inlet 2 Step 2 Lo** when stage 2 is activated at minimum speed. This parameter is adjusted in 1% increments, from 0% to 100%.

↓ **Inlet 2 Step 2 Lo** (Message: "2 S2L")

This setting, visible if **Inlet 1** and **Inlet 2** are set to ON, defines the position inlet 2 will take when stage 2 is activated at its minimum speed. Inlet opening will increase as stage 2's speed increases to reach **Inlet 2 Step 2 Hi** when stage 2 is running at full speed. Inlet will **not** take this position during de-icing. This parameter is adjusted in 1% increments, from 0% to 100%.

↓ **Inlet 2 Step 2 Hi** (Message: "2 S2H")

This setting, visible if **Inlet 1** and **Inlet 2** are set to ON, defines the position inlet 2 will take when stage 2 is activated at full speed. This parameter is adjusted in 1% increments, from 0% to 100%.

↓ **Inlet 2 Step 3** (Message: "2 S3")

This setting, visible if **Inlet 1** and **Inlet 2** are set to ON, defines the position inlet 2 will take when stage 3 is activated. This parameter is adjusted in 1% increments, from 0% to 100%.

↓ **Inlet 2 Step 4** (Message: "2 S4")

This setting, visible if **Inlet 1** and **Inlet 2** are set to ON and stage 4 is used as a ventilation stage (DIP switches # 5 or 9, are set to OFF), defines the position inlet 2 will take when stage 4 is activated. This parameter is adjusted in 1% increments, from 0% to 100%.

↓ **Inlet 2 Step 5** (Message: "2 S5")

This setting, visible if **Inlet 1** and **Inlet 2** are set to ON and stage 5 is used as a ventilation stage (DIP switches # 6 and 9, or DIP switch #5, are set to OFF), defines the position inlet 2 will take when stage 5 is activated. This parameter is adjusted in 1% increments, from 0% to 100%.

↓ **Inlet 2 Step 6** (Message: "1 S6")

This setting, visible if **Inlet 1** and **Inlet 2** are set to ON and stage 6 is used as a ventilation stage (DIP switches # 5 and 9, are set to OFF), defines the position inlet 2 will take when stage 6 is activated. This parameter is adjusted in 1% increments, from 0% to 100%.

↓ **Inlet 2 Over Open** (Message: "2 Oop")

This setting, visible if **Inlet 1** and **Inlet 2** are set to ON, determines the position inlet 2 will take when temperature is equal to or higher than the last ventilation stage's activation point + **Inlet 2 Over Bandwidth**. This parameter is adjusted in 1% increments, from 0% to 100%.

↓ **Inlet 2 Over Bandwidth** (Message: "2 Obd")

This parameter, visible if **Inlet 1** and **Inlet 2** are set to ON, sets the temperature at which inlet 2 opening will be equal to **Inlet 2 Over Open**. When temperature is higher than the last ventilation stage's activation point, inlet 2 has two possible behaviors depending on the **Inlet 2 Drop** option. It will either increase its opening progressively throughout this bandwidth or maintain its position until temperature reaches the last ventilation stage's activation point + **Inlet 2 Over Bandwidth**. In both cases, inlet 2 will open at **Inlet 2 Over Open** when temperature reaches the last ventilation stage's activation point + **Inlet 2 Over Bandwidth**. In the latter case, a differential of 0.5° will be used to determine at which temperature inlet 2 will return to its previous position (**Inlet 1 Step 3**, **Inlet 1 Step 4**, **Inlet 1 Step 5** or **Inlet 1 Step 6**). This parameter is adjusted in 0.1° increments, from 0.5°F to 20.0°F (0.3°C to 11.0°C).

↓ **Inlet 2 Drop** (Message: "2 drp")

This parameter, visible if **Inlet 1** and **Inlet 2** are set to ON, determines inlet 2 behavior when temperature is above the last ventilation stage's activation point. If this option is set to ON, inlet 2 will maintain its position until temperature reaches the last ventilation stage's activation point + **Inlet 2 Over Bandwidth**, at which point it will open at **Inlet 2 Over Open**. A fixed differential of 0.5° will be used on this logic. If this option is set to OFF, inlet 2 will increase its opening progressively throughout this **Inlet 2 Over Bandwidth** to reach **Inlet 2 Over Open** at the end of this same bandwidth.

Example: Inlet opening with drop option set to OFF

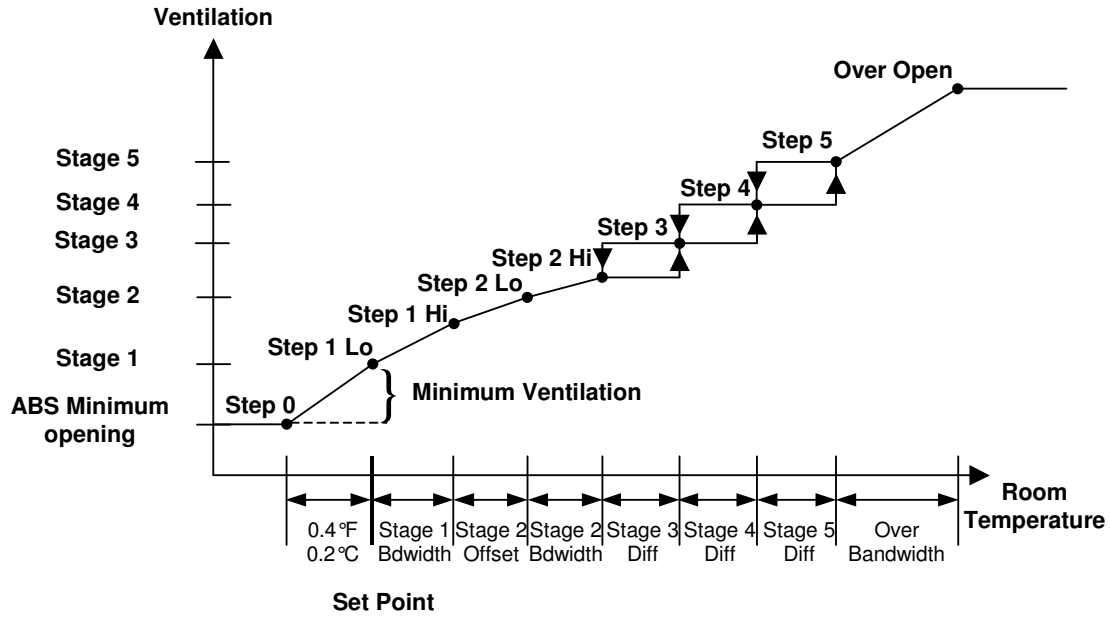

Example: Inlet opening with drop option set to ON

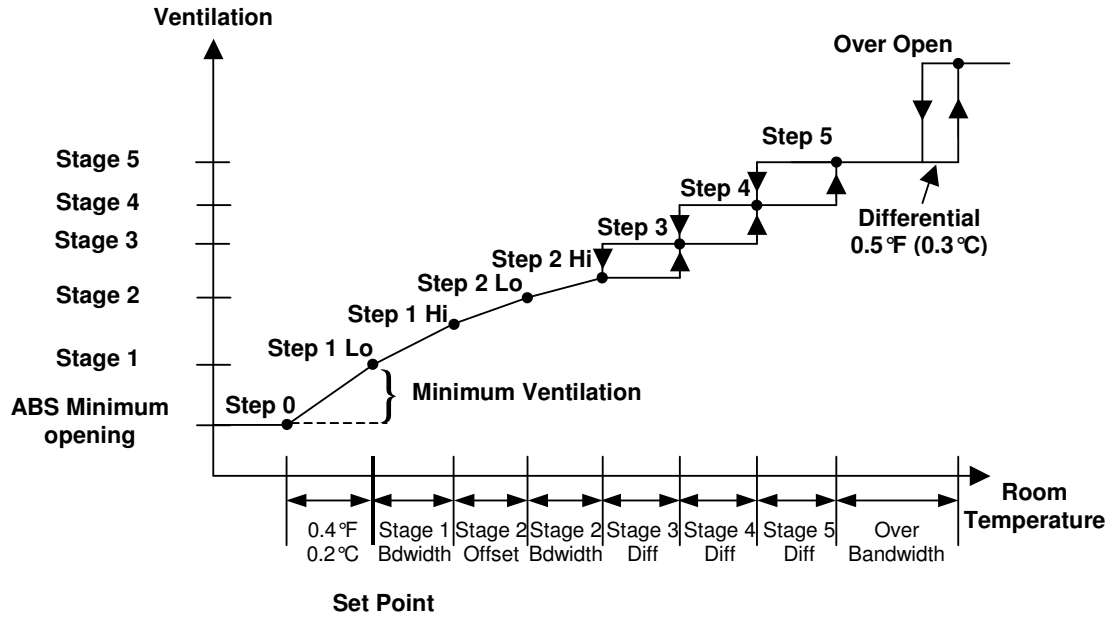

DIP SWITCHES AND PROBES

DIP SWITCHES			
DESCRIPTION	DIP SWITCH NO.	POSITION	OPERATING MODE
Locking the parameters	1	ON OFF	Locked parameters Unlocked parameters
Reserved	2		Reserved
Probe 2	3	ON OFF	Enabled Disabled
Probe 3	4	ON OFF	Enabled Disabled
Probe 4	5	ON OFF	Enabled Disabled
Heating stages	6	ON OFF	Heating No heating
Number of heating stages	7	ON OFF	2 heating stages 1 heating stage
Zoned/cascading heating	8	ON OFF	Zoned heating Cascading heating
Mist	9	ON OFF	Mist on Mist off
Offset on vent stages	10	ON OFF	2°F (1.1 °C) offset on vent. stages No offset on vent. stages
De-Icing	11	ON OFF	Enabled Disabled
Reserved	12		Reserved

PROBES CONTROLLING HEAT ZONES			
Activated Probes	Probe(s) Controlling Zone A	Probe(s) Controlling Zone B	ROOM TEMP. averaged from which probe reading(s)
1	1	1	1
1,2	1	2	1,2
1,3	1	3	1,3
1,4	1	4	1,4
1,2,3	1,2	3	1,2,3
1,2,4	1,2	4	1,2,4
1,3,4	1	3,4	1,3,4
1,2,3,4	1,2	3,4	1,2,3,4

For more details, refer to the wiring diagram at the end of this document.

MOTOR TYPES

MOTOR TYPES				
TYPE NUMBER	BRAND NAME	MODEL	DIAMETER	VOLTAGE
1 to 8	Other	—	—	—
9	Val-Co	FW08W120MSA	8"	230 V
	Val-Co	FW10W130MSA	10"	
	Val-Co	PM12^140MPA	12"	
	Val-Co	PM16^140MPA	16"	
10	Val-Co	PM21^140MPA	21", 3 pales	230 V
	Val-Co	PM21^190LPA	21", 4 pales	
	Val-Co	PM24^210MPA	24"	
	Val-Co	PM36^280M*A	36"	

TECHNICAL SPECIFICATIONS

DESCRIPTION	VALUE
Input power	10 W
Power source (line)	115/230 VAC, -20%, +10%, 50/60 Hz
Power fuse	0.125 A @ 250 V, slow blow, 5 X 20 mm
Stages 3 to 6	10 A @ 125/250 VAC 1 HP @ 250 VAC ½ HP @ 125 VAC
Stage 1 and stage 2	10 A @ 115/230 VAC Minimal charge: 25 mA @ 50/60 Hz
Alarm relay	1 A @ 30 VDC
Stage 1 and stage 2 power source	115/230 VAC, -20%, +10%, 50/60 Hz (same power as line power)
Stage 1 and stage 2 fuse	15 A @ 250 VAC, slow blow
Storage temperature	-4°F to 130°F (-20°C to 55°C)
Operating temperature	32°F to 120°F (0°C to 50°C)
Temperature range – inside probes	-6.0°F to 168.6°F (-21.1°C to 75.9°C)
Weight	5.2 lbs. (2.36 kg)
Dimensions	11" X 7" X 6" (27.9 X 17.8 X 15.2 cm)

FACTORY SETTINGS

	Position	Parameter A↑ B↓	Factory Setting	Range of Values
ROOM TEMP.	ROOM TEMP. MIN./MAX.	Room Temp. Readout	—	-6.0 to 168.6°F (-21.1 to 75.9°C)
		Lo	—	
		Hi	—	
		Probe 1 Readout	—	
		Probe 1 Lo	—	
		Probe 1 Hi	—	
		Probe 2 Readout	—	
		Probe 2 Lo	—	
		Probe 2 Hi	—	
		Probe 3 Readout	—	
		Probe 3 Lo	—	
		Probe 3 Hi	—	
		Probe 4 Readout	—	
		Probe 4 Lo	—	
		Probe 4 Hi	—	
Test Mode	OFF			
Software Version	3	3		
SET POINT	SET POINT/ T°CURVE	Set Point	75.0°F (24.0°C)	-40.0 to 100.0°F (-40.0 to 40.0°C)
		Adjust Day	—	1 to 255
		Adjust Temperature	—	-40.0 to 100.0°F (-40.0 to 40.0°C)
	CURRENT RAMPING DAY	Current Day	OFF	OFF, 1 to 255
		Adjust Current Day	OFF	
STAGE 1	MIN. SPEED/ CURVE	Minimum Speed	40	12 to 100%
		Adjust Day	—	OFF, 1 to 255
		Adjust Minimum Speed	—	12 to 100%
	BANDWIDTH/ TIMER	Bandwidth	2.0°F (1.0°C)	0.5 to 20.0°F (0.3 to 11.0°C)
		Min. Ventilation On Time	15	0 to 900 seconds
		Min. Ventilation Off Time	0	
		Motor Type	10	1 to 10
	HUMIDITY MIN./MAX.	Readout	—	10 to 90 RH%
		Lo	—	
		Hi	—	
	R.H. COMPENSATION	Compensation Option	OFF	ON/OFF
Humidity Set Point		65	10 to 90 RH%	
R.H. Speed Compensation		50	0 to 100%	
STAGE 2	OFFSET/ BANDWIDTH	Offset	2.0°F (1.0°C)	0.5 to 20.0°F (0.3 to 11.0°C)
		Bandwidth		
	MIN. SPEED	Minimum Speed	40	12 to 100%
		De-icing Cycle Time	1	1 to 720 minutes
		De-icing On Time	0	0 to 900 seconds
		Motor Type	10	1 to 10

	Position	Parameter A↑ B↓	Factory Setting	Range of Values	
STAGES 3-4	DIFF.	Stage 3 Differential	2.0°F (1.0°C)	0.5 to 20.0°F (0.3 to 11.0°C)	
		Stage 4 Differential	2.0°F (1.0°C)		
STAGES 5-6	DIFF.	Stage 5 Differential	2.0°F (1.0°C)	0.5 to 20.0°F (0.3 to 11.0°C)	
		Stage 6 Differential	2.0°F (1.0°C)		
MIST	TIMER ON (SEC.)	On Time	60	0 to 900 seconds	
	TIMER OFF (MIN.)	Off Time	6	0 to 20 minutes	
	OFFSET/DIFF.	Offset	8.0°F (7.0°C)	0.5 to 20.0°F (0.3 to 11.0°C)	
		Differential	2.0°F (1.0°C)		
Humidity Turn Off		75	40 to 90 RH%, OFF		
HEAT 2	OFFSET/DIFF.	Offset	3.0°F (3.0°C)	-10.0 to 20.0°F (-5.5 to 11.0°C)	
		Differential	2.0°F (1.0°C)	0.5 to 20.0°F (0.3 to 11.0°C)	
		Max. Diff. Prot. Bet. Zones	7.5°F (4.0°C)	5.0 to 40.0°F (3.0 to 22.0°C), OFF	
HEAT 1	OFFSET/DIFF.	Offset	3.0°F (3.0°C)	-10.0 to 20.0°F (-5.5 to 11.0°C)	
		Differential	2.0°F (1.0°C)	0.5 to 20.0°F (0.3 to 11.0°C)	
ALARM		Low Offset	10.0°F (6.0°C)	0.5 to 40.0°F (0.3 to 20.0°C)	
		High Offset	12.0°F (7.0°C)	0.5 to 40.0°F (0.3 to 22.0°C)	
		Critical High Alarm	95.0°F (30.0°C)	-40.0 to 120.0°F (-40.0 to 50.0°C)	
		Alarm Individual/All	ind.	ind./ALL	
RV-F-1A OPTION INLET1	ALARM OFFSETS	Inlet 1	OFF	ON/OFF	
		Inlet 1 Step 0	5	0 to 100%	
		Inlet 1 Step 1 Lo	10		
		Inlet 1 Step 1 Hi	25		
		Inlet 1 Step 2 Lo	50		
		Inlet 1 Step 2 Hi	60		
		Inlet 1 Step 3	75		
		Inlet 1 Step 4	90		
		Inlet 1 Step 5	90		
		Inlet 1 Step 6	90		
		Inlet 1 Over Open	100		
		Inlet 1 Over Bandwidth	5.0°F (3.0°C)		0.5 to 20.0°F (0.3 to 11.0°C)
		Inlet 1 Drop	OFF		ON/OFF
		RV-F-1A OPTION INLET2	ALARM OFFSETS		Inlet 2
Inlet 2 Step 0	5			0 to 100%	
Inlet 2 Step 1 Lo	10				
Inlet 2 Step 1 Hi	25				
Inlet 2 Step 2 Lo	50				
Inlet 2 Step 2 Hi	60				
Inlet 2 Step 3	75				
Inlet 2 Step 4	90				
Inlet 2 Step 5	90				
Inlet 2 Step 6	90				
Inlet 2 Over Open	100				
Inlet 2 Over Bandwidth	5.0°F (3.0°C)				0.5 to 20.0°F (0.3 to 11.0°C)
Inlet 2 Drop	OFF				ON/OFF

WIRING DIAGRAM RVS-24HA

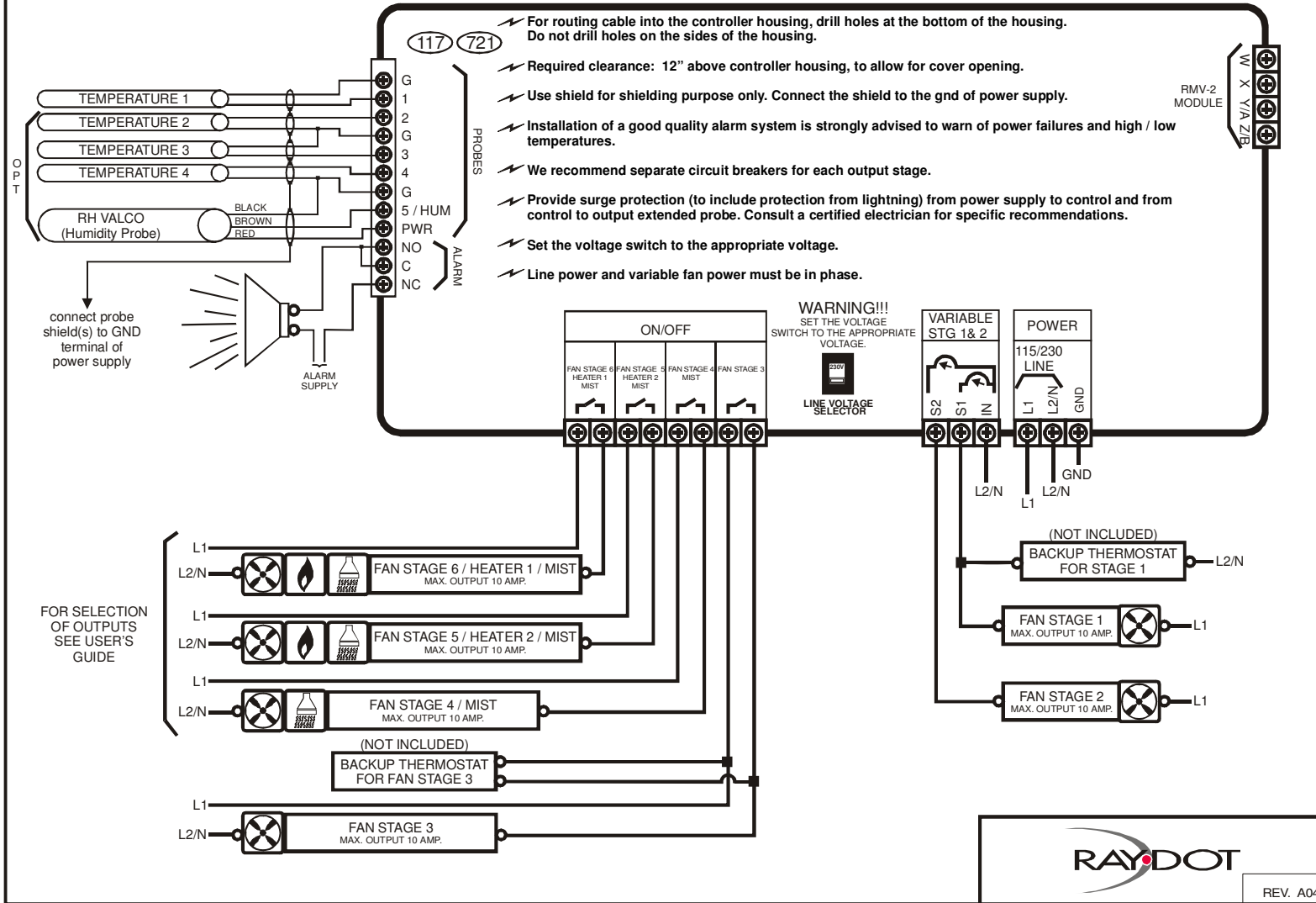

WIRING DIAGRAM

