

115/230 VAC SELECTION SWITCH

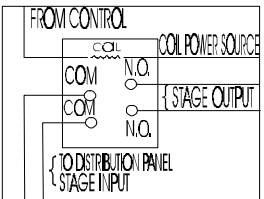

THE CAPACITY OF THE INTERNAL RELAYS IS 6 AMPS. "MOTOR LOAD". WE RECOMMEND INSTALLING EXTERNAL RELAYS ON "ON/OFF" STAGES HOOKED TO MOTORS.



### NOTES

1. INSTALLATION OF A GOOD QUALITY ALARM SYSTEM IS STRONGLY ADVISED TO WARN OF POWER FAILURES AND HIGH/LOW TEMPERATURES.
2. PROVIDE SURGE PROTECTION (TO INCLUDE PROTECTION FROM LIGHTNING) FROM POWER SUPPLY TO CONTROL AND FROM CONTROL TO OUTPUT EXTENDED PROBE. CONSULT A CERTIFIED ELECTRICIAN FOR SPECIFIC RECOMMENDATIONS.
3. SAME PHASES MUST BE USED TO POWER VARIABLE FANS AND CONTROLS ON 3 PHASES POWER.
4. WE RECOMMEND SEPARATE CIRCUIT BREAKERS FOR EACH OUTPUT STAGE.

## AUXILIARY 1

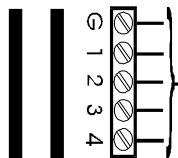
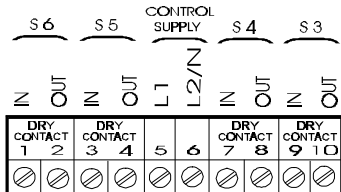

OPTIONAL  
OPTIONAL  
OPTIONAL

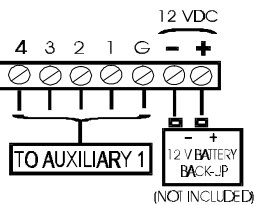
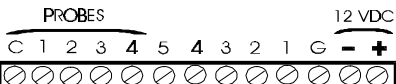

## MASTER

115/230 VAC SELECTION SWITCH

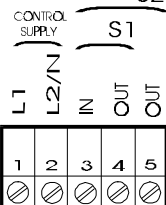

DO NOT DRILL THE SIDES OF THE UNIT CONTROL. USE AVAILABLE KNOCK OUTS AT THE BOTTOM OF THE UNIT.

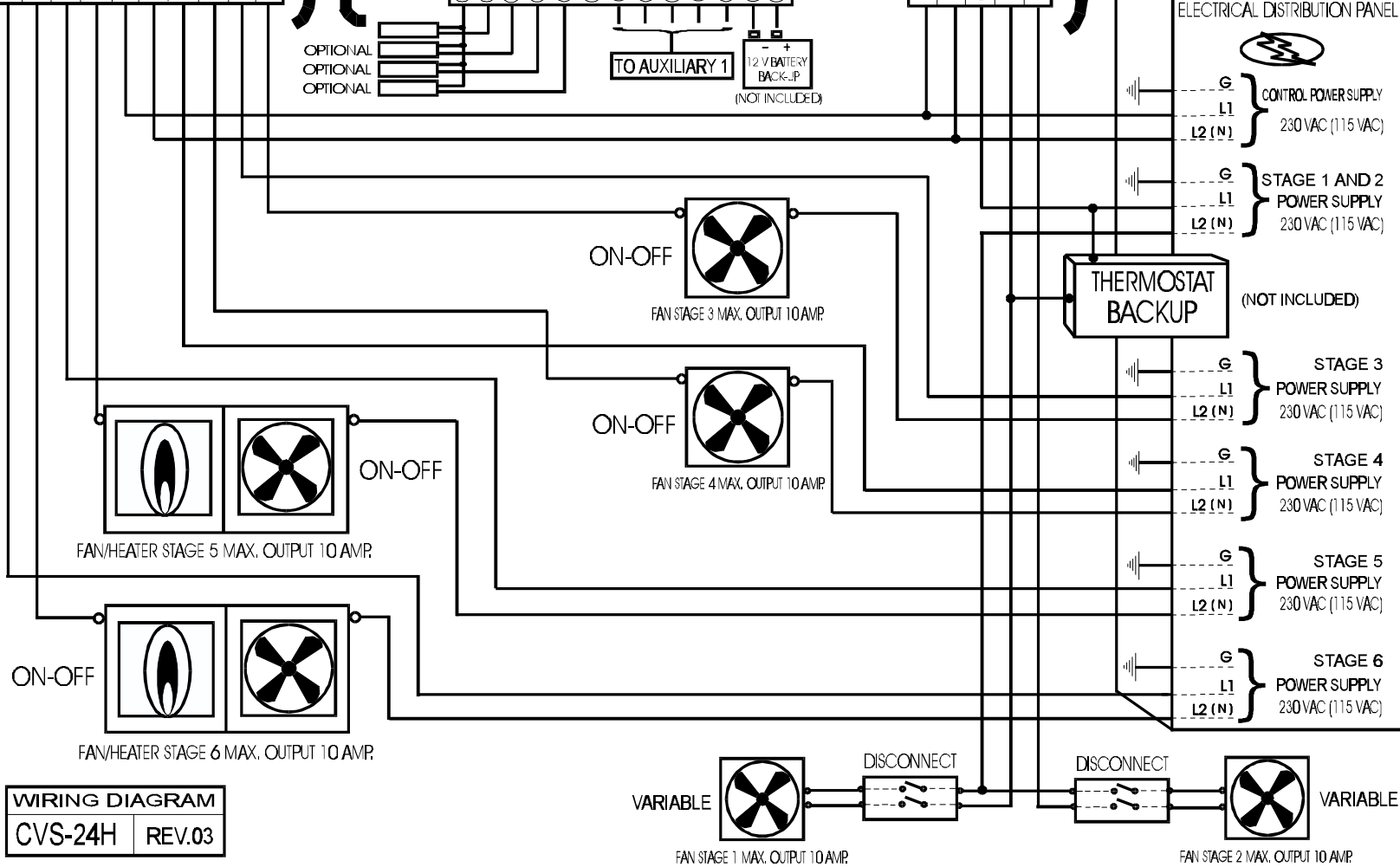

WIRING DIAGRAM  
CVS-24H REV.03

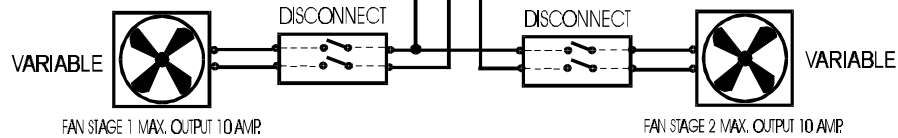

FAN STAGE 1 MAX. OUTPUT 10 AMP.

FAN STAGE 2 MAX. OUTPUT 10 AMP.