

---

---

# Temperature Controller

# OVATION 113

## User's Guide

---

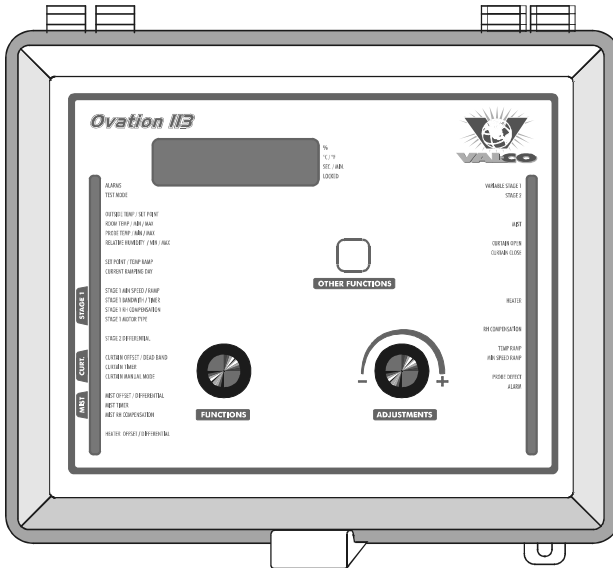

---

Read this guide carefully before using the controller.

<b>TABLE OF CONTENTS</b> .....	2
<b>PRECAUTIONS</b> .....	3
<b>FEATURES</b> .....	4
<b>LOCATION OF THE CONTROLS</b> .....	6
Controller Status LEDs .....	7
Internal Switches .....	7
<b>INSTALLATION</b> .....	8
Mounting Instructions .....	8
Connections .....	8
Motor Types .....	9
Temperature Probes .....	10
<b>CHANGING THE PARAMETER SETTINGS</b> .....	12
Using the Display .....	12
Locking the Parameter Settings .....	13
<b>TEMPERATURE SETTINGS</b> .....	14
Temperature Units .....	14
Viewing Temperatures .....	14
Temperature Set Point .....	17
Temperature Ramp .....	18
<b>VENTILATION SETTINGS</b> .....	22
Cooling Operation .....	22
Minimum Ventilation Cycle .....	24
Minimum Ventilation Cycle Settings .....	24
Humidity Compensation .....	26
Minimum Ventilation Speed Ramp .....	29
Differential Settings .....	33
Mist Cooling .....	34
<b>NATURAL VENTILATION</b> .....	37
Principle of Operation .....	37
Settings .....	40
<b>HEATER SETTINGS</b> .....	43
<b>ALARM SETTINGS</b> .....	45
<b>TEST MODE</b> .....	47
<b>TROUBLESHOOTING GUIDE</b> .....	48
<b>TECHNICAL SPECIFICATIONS</b> .....	52
<b>FACTORY SETTINGS</b> .....	53
<b>MEMORY CARD</b> .....	54
<b>GLOSSARY</b> .....	57

## PRECAUTIONS

We strongly recommend installing supplementary natural ventilation as well as a back-up thermostat on at least one cooling stage (refer to the wiring diagram enclosed with this user's manual to connect the thermostat).

Although fuses at the input and outputs of the controller protect its circuits in case of an overload or overvoltage, we recommend installing an additional protection device on the controller's supply circuit.

The room temperature where the controller is located **MUST ALWAYS REMAIN BETWEEN 32° F AND 104° F (0° C TO 40° C)**.

To avoid exposing the controller to harmful gases or excessive humidity, it is preferable to install it in a corridor.

**DO NOT SPRAY WATER ON THE CONTROLLER**

### FOR CUSTOMER USE

Enter the serial number located on the side of the controller below for future reference.

Model number:      OVATION 113

Serial number:      \_\_\_\_\_

## FEATURES

The OVATION 113 is an electronic device used for environmental control in livestock buildings. It allows the user to maintain a specified target temperature by controlling the operation of ventilation and heating equipment. One stage of variable speed fans can be connected to the controller, one stage of constant-speed fans, one curtain, one mist stage and one heating output can be connected to the controller.

The main features of the OVATION 113 are as follows:

### **FIVE-DIGIT DISPLAY**

A five-digit display provides a high level of accuracy, allowing the user to specify a temperature to within one tenth of a degree (in Fahrenheit or Celsius units).

### **PILOT LIGHTS**

Pilot lights indicating the state of outputs allow the user to monitor the operation of the system without having to enter the building.

### **MINIMUM VENTILATION CYCLE**

When ventilation is not required for cooling, the first stage fans can be operated either continuously or intermittently to reduce the level of humidity and supply oxygen to the room.

### **RAMPING FUNCTIONS**

Ramping functions provide an automatic adjustment of the set point and minimum ventilation fan speed over a given period of time.

### **CHOICE OF TEN MOTOR TYPES**

The variation in motor speed resulting from a change in voltage will depend on the make and capacity of the motor. In order to achieve a high degree of compatibility between controller and motor, the user can choose from among ten different motor types, thus ensuring that the correct voltage is supplied.

### **HIGH/LOW TEMPERATURE ALARM OUTPUT**

### **HUMIDITY COMPENSATION**

The stage 1 minimum speed can be adjusted automatically as a function of relative humidity. As humidity increases, the minimum speed of stage 1 fans increases proportionally to compensate for the change.

**FULL-SPEED FAN START-UP**

In order to overcome the inertia of the ventilation system components and de-ice the fan blades in cold weather conditions, the controller supplies maximum voltage to the variable speed fans during the 2 seconds immediately following each start-up.

**FOUR INDEPENDENT TEMPERATURE PROBE INPUTS**

Up to four temperature probes can be connected to the controller in order to obtain a more accurate reading of the average room temperature and a faster reaction time.

**OUTSIDE TEMPERATURE COMPENSATION ON CURTAIN SPEED**

Curtain opening and closing times can be decreased as a function of outside temperature.

**OVERLOAD AND OVERVOLTAGE PROTECTION**

Fuses are installed at the input and outputs of the controller to protect its circuitry in the case of an overload or overvoltage.

**MEMORY CARD:**

A memory card is used to create a copy of your controller's parameters.

**COMPUTER CONTROL**

The controller can be connected to a computer, thus making it possible to centralize the management of information and diversify control strategies.

**CONTROL OF AIR INLET MOVEMENT**

If the OVATION 113 is used in combination with a DWR-F-1A controller, the movement of the air inlets can be coordinated with the operation of the fans using a potentiometer located on the panel drive. This allows the air inlets to be adjusted correctly, without the influence of uncontrollable factors such as wind or air from adjoining rooms.

**TEST MODE**

A test mode allows you to simulate temperature changes and verify controller performance.

## LOCATION OF THE CONTROLS

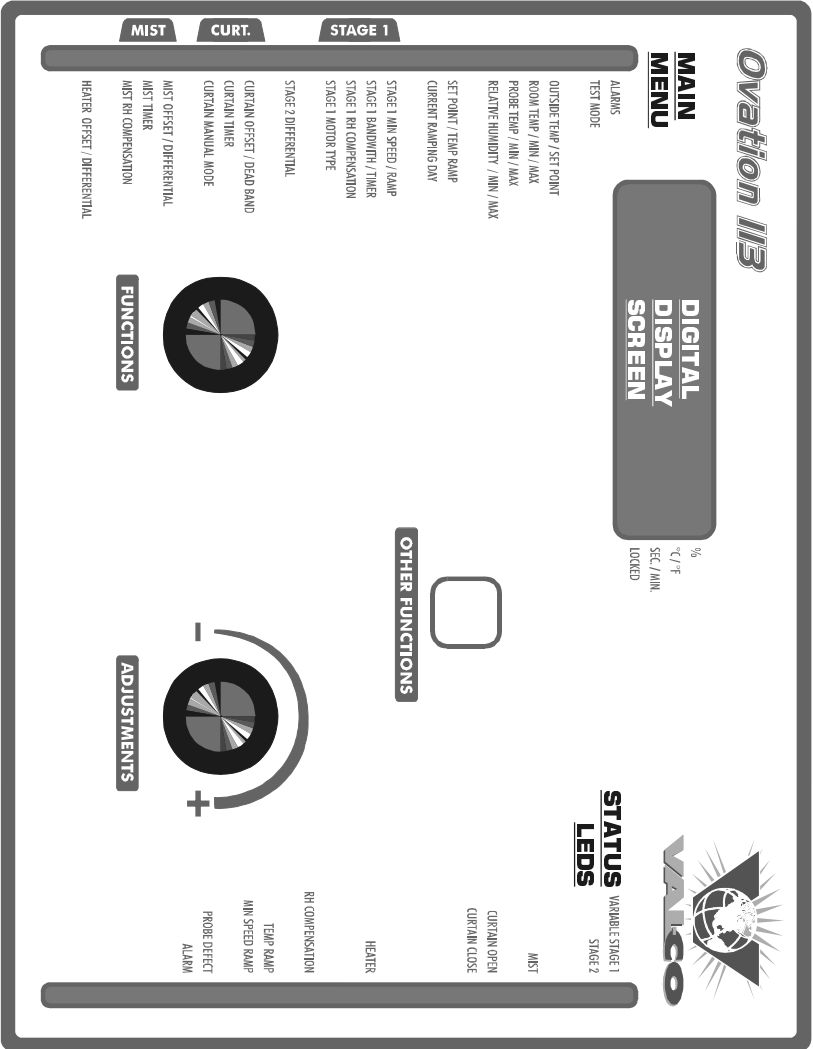

## Controller Status LEDs

LED	MEANING
VARIABLE STAGE 1	Turns on when variable stage 1 fans are on.
STAGE 2	Turns on when stage 2 is on.
MIST	Turns on when the mist output is on.
CURTAIN OPEN	Turns on when the curtain opens.
CURTAIN CLOSE	Turns on when the curtain closes.
HEATER	Turns on when the heating output is on.
RH COMPENSATION	Turns on when a RH compensation function is on.
TEMP RAMP	Turns on when the temperature ramp function is activated.
MIN SPEED RAMP	Turns on when the minimum speed ramp function is activated.
PROBE DEFECT	Turns on when a probe is defective.
ALARM	Turns on when an alarm condition is detected.

## Internal Switches

Internal switches are located on the inside of the front cover. All switches are set to OFF when the controller is shipped from the factory,

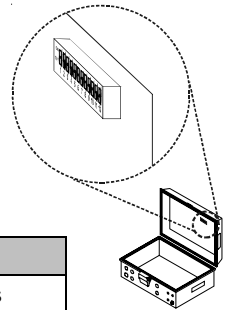

#	OFF	ON
1	Unlocked parameters	Locked parameters
2	Fahrenheit degrees	Celsius degrees
3	Probe 2 disabled	Probe 2 enabled
4	Probe 3 disabled	Probe 3 enabled
5	Probe 4 disabled	Probe 4 enabled
6	Adjustable hysteresis	Fix hysteresis of 2.0°F
7	Reserved	
8	Reserved	
9	Reserved	
10	Reserved	
11	Reserved	
12	Switch from OFF to ON to acces the transfer menu	

## INSTALLATION

### Mounting Instructions

Open the latch and lift the cover. Remove the black caps located on each of the four mounting holes. Mount the enclosure on the wall using four screws. Be sure the electrical knockouts are at the bottom of the enclosure in order to prevent water from entering the controller. Insert the screws in the mounting holes and tighten. Fasten the four black caps provided with the controller onto the four mounting holes. The enclosure must be mounted in a location that will allow the cover to be completely opened right up against the wall.

### Connections

To connect the controller, refer to the wiring diagram enclosed with this user's manual.

- Set the voltage switch to the appropriate voltage.
- Use the electrical knockouts provided at the bottom of the enclosure. Do not make additional holes in the enclosure, particularly on the side of the enclosure when using a computer communications module.
- It may be necessary to install a transformer in order to supply the appropriate voltage to the heating unit.

**ALARM CONNECTION:** There are two types of alarms on the market. One type activates when current is cut off at its input, whereas the other activates when current is supplied at its input. For an alarm of the first type, use the NO terminal as shown on the wiring diagram. For an alarm of the second type, use the NC terminal.



ALL WIRING MUST BE DONE BY AN AUTHORIZED ELECTRICIAN AND MUST COMPLY WITH APPLICABLE CODES, LAWS AND REGULATIONS. BE SURE POWER IS OFF BEFORE DOING ANY WIRING TO AVOID ELECTRICAL SHOCKS AND EQUIPMENT DAMAGE.



## Motor Types

The relationship between the voltage supplied to a motor and its operating speed is described by a motor curve. This curve varies with the make and capacity of the motor. The various motors available in the industry have been divided into ten categories and the controller has been programmed with a different motor curve for each of these categories. To ensure that the controller supplies the correct voltages, an appropriate curve must be selected for variable stage 1 to the type of fan motors used.

### 1 Selecting a Motor Type for Stage 1

Refer to the list of motors enclosed with this user's to choose the proper motor type.

- Set the function to **STAGE 1 MOTOR TYPE**. Stage 1 motor type is displayed, alternating with the letters "tYPE".
- Press the push-button once. The motor type flashes.
- Use the adjustment knob to adjust the motor type to the desired value.
- Press the push-button once again to validate the new value.

## Temperature Probes

### 1 Connecting the Probes

The controller is supplied with one temperature probe connected to input # 1. Up to three additional probes can be connected to the controller in order to obtain a more accurate reading of the average room temperature and a faster reaction time.

- Use inputs # 2, 3 and 4 to connect additional probes, as shown on the wiring diagram enclosed.

**CAUTION:** Probes operate at low voltage and are isolated from the supply. Be sure that probe cables remain isolated from all high voltage sources. In particular, do not route the probe cables through the same electrical knockout as other cables. Do not connect the shield from the probe cable to a terminal or a ground.

Switches are used to activate or deactivate the additional probes connected to the controller.

- Activate each additional probe by setting the appropriate switch to **ON**:
  - Switch # 3 activates the probe connected to input # 2.
  - Switch # 4 activates the probe connected to input # 3.
  - Switch # 5 activates the probe connected to input # 4.

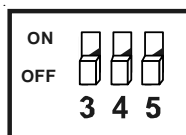

## 2 Extending the Probes

Each probe can be extended up to 500 feet (150 meters). To extend a probe:

- Use a shielded cable of outside diameter between 0.245 and 0.260 in (6.22 and 6.60 mm) (the cable dimensions should not be under 18 AWG) to ensure the cable entry is liquid tight. Do not ground the shielding.
- It is preferable to solder the cable joint to ensure a proper contact between the two cables.

**CAUTION:** Do not run probe cables next to other power cables. When crossing over other cables, cross at 90°.

## 3 Defective Probes

If a defective probe is detected, the Defective Probe Pilot Light turns on. The room temperature shown on the display corresponds to the average temperature measured by the probes in working condition.

To identify the defective probe:

- Set the function to **PROBE TEMP / MIN / MAX**. If the probe connected to input # 1 is not defective, the letters "PR1" are displayed, alternating with the on/off state of the probe and the temperature measured by the probe. If the probe is defective, the letters "PR1" are displayed, alternating with the state of the probe and the letter "P".
- Press the push-button to step to the following probe.
- Proceed as explained above to make sure all probes are in working order.

## CHANGING THE PARAMETER SETTINGS

### Using the Display

#### Flashing Values:

The display will flash in certain cases and not in others. The flashing indicates that the value shown can be adjusted. A value that is not flashing cannot be adjusted.



#### Relative and Absolute Values:

Some parameter adjustments are displayed both as a relative value and an absolute temperature. This applies all heating and cooling differentials, the mist differential and the heater offset. The parameter is first displayed as a relative value. The corresponding absolute temperature is displayed after six seconds if no action is taken by the user. The absolute value is the temperature at which the stage turns on (except in the case of the heater and mist offsets where the value displayed is the temperature at which the stage turns off). If the user turns the adjustment knob, the relative value reappears. For example, when the user turns the selection knob to a differential position, i.e. STAGE 2 DIFFERENTIAL, the sequence is as follows:

- (i) The current differential for stage 2 flashes on the display, alternating with "2 dIF".



- (ii) If, after about 6 seconds, no action is taken by the user, the absolute temperature value is displayed, alternating with "St 2 On". In this case, the absolute value is: Set Point + Bandwidth 1 + Differential 2.



(iii) When the user turns the adjustment knob to make an adjustment to the stage 2 differential, the relative value reappears on the display.



## Locking the Parameter Settings

The parameter settings can be locked to prevent accidentally modifying them. When the settings are locked, only the temperature set point and the Stage 1 minimum ventilation speed can be modified (as long as the temperature ramp and the minimum ventilation speed ramp are deactivated respectively).

### To lock the parameter settings:

- Set internal switch # 1 to **ON**. The Locked Parameter Pilot Light turns on.



### To unlock the parameter settings:

- Set internal switch # 1 to **OFF**. The Locked Parameter Pilot Light turns off.



## TEMPERATURE SETTINGS

### Temperature Units

Temperatures can be displayed in either Celsius or Fahrenheit units

- Set internal switch # 2 to the desired position:

**ON:** to display temperatures in Celsius units.

**OFF:** to display temperatures in Fahrenheit units.



### Viewing Temperatures

#### 1 Viewing the Room Temperature

The room temperature is the average value of all temperatures measured by activated probes in proper operating condition.

- Set the function to **ROOM TEMP MIN / MAX**. The average room temperature is displayed.

#### 2 Viewing the Outside Temperature

- Set selection knob to **OUTSIDE TEMPERATURE**. The outside temperature is displayed.

### 3 Viewing Probe Temperatures

The controller can display probe temperatures individually. Probes can also be turned on or off to control the temperature in different parts of the building.

- Set the function to **PROBE TEMP / MIN / MAX**. The temperature reading of probe 1 is displayed, alternating with the letters "Pr 1" and the on/off state of the probe.
- For each additional probe, press the push-button. The temperature reading of probe x is displayed, alternating with the letters "Pr x" and the on/off state of the probe, etc.

### 4 Viewing Min/Max Temperatures

Follow this procedure to see the lowest and highest room temperature values that have been recorded since the last reset.

- Set the function to **ROOM TEMP MIN / MAX** or **OUTSIDE TEMP/SET POINT**. The corresponding temperature is displayed.
- Turn the adjustment knob clockwise by one notch. The maximum room temperature is displayed, alternating with the letters "Hi".
- Turn the adjustment knob counterclockwise one notch. The room temperature is displayed once again.
- Turn the adjustment knob counterclockwise one notch further. The minimum room temperature flashes on the display, alternating with the letters "Lo". If any minimum or maximum temperature reading is out of range, the controller displays the letter "P" instead of displaying a temperature.

**NOTE:** If you let the display flash for more than 10 seconds, the controller resets the min and max temperatures currently in memory (the display stops flashing to indicate the reset has been done).

## 5 Viewing Min/Max Probe Temperatures

Follow this procedure to see the lowest and highest temperature readings that have been recorded by each probe since the last reset.

- Set the function to **PROBE TEMP / MIN / MAX**. The temperature reading of probe 1 is displayed, alternating with the letters "Pr 1" and the on/off state of the probe.
- Turn the adjustment knob clockwise by one notch. The maximum temperature of probe 1 is displayed, alternating with the letters "Pr1 Hi".
- Turn the adjustment knob counterclockwise one notch. The current temperature of probe 1 is displayed once again.
- Turn the adjustment knob counterclockwise one notch further. The minimum temperature of probe 1 flashes on the display, alternating with the letters "Pr1 Lo".
- Turn the adjustment knob clockwise by one notch. The current temperature of probe 1 is displayed once again.
- Press the push-button to select another probe then proceed as explained above to see the minimum and maximum temperature readings of the desired probe.

**NOTE:** If you let the display flash for more than 10 seconds, the controller resets the minimum and maximum temperatures of the selected probe (the display stops flashing to indicate that the reset has been done).



## Temperature Set Point

The temperature set point is the target room temperature. It can be adjusted between -40.0°F and 120.0°F (-40.0°C and 48.9°C).

### Adjusting the Temperature Set Point

- Set the function to **SET POINT/TEMP RAMP**. The current set point flashes on the display.
- Use the adjustment knob to adjust the set point to the desired value.

**NOTE:** The temperature set point can only be adjusted while the temperature ramp is deactivated (see following section).

## Temperature Ramp

The user can define a temperature ramp to adjust the set point automatically over a given time period.

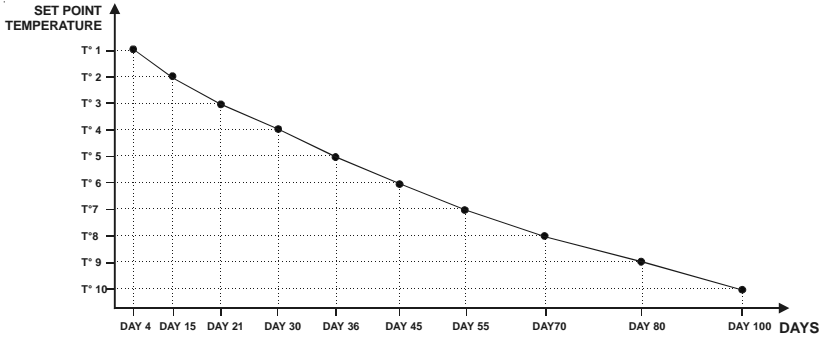

A ramp is defined using ten points. Each point specifies a day number and a set point for that day. Once the points of the ramp are defined, the ramp must be activated. The controller will change the temperature set point every hour in a linear fashion between consecutive points of the ramp. When the last point of the ramp is reached, the temperature set point for that day is maintained until the ramp is reactivated.

### NOTES :

i) All ten points of the ramp must be specified. If ten points are not needed, repeat the last temperature value for each unnecessary point.

ii) Certain restrictions apply to reduce the risk of errors:

- The highest possible day number is 255.
- Decreasing day numbers are not allowed.
- Increasing temperatures are not allowed.
- The temperature variation cannot exceed 3° F (1.6° C) per day.

## 1 Specifying the Ramp

The points of the ramp can only be modified while the ramp is disabled. Refer to the 4<sup>th</sup> section of this chapter to disable the ramp.

- Set the function to **SET POINT/TEMP RAMP**. The current temperature set point flashes on the display – the value does not flash if the ramp is activated. Refer to the 4<sup>th</sup> section of this chapter to disable the ramp.

Repeat the following steps for each of the ten points (point 0 to point 9):

- Press the push-button. The day number of the first point of the ramp (point 0) is displayed "d0 x" (where "x" is the day number).
- Using the adjustment knob, set the day number of the first point of the ramp to the desired value.
- Press the push-button once again. The temperature set point associated with the first point of the ramp (point 0) is displayed "t0".
- Using the adjustment knob, adjust the set point of the first point of the ramp to the desired value.

Once all points of the ramp are defined, activate the ramp as explained below.

## 2 Activating the Temperature Ramp

If you have just finished specifying the points on the ramp:

- Press the push-button once again. The word **OFF** flashes on the display.
- Turn the adjustment knob clockwise one notch. The word **ON** flashes on the display and the Temperature Ramp Pilot Light turns on, indicating that the temperature ramp is now activated.

If you have previously defined the points on the ramp:

- Set the function to **SET POINT/TEMP RAMP**. The current temperature set point flashes on the display.
- Press the push-button to display all points of the ramp until the word **OFF** appears (twenty-one clicks).
- Turn the adjustment knob clockwise one notch. The word **ON** flashes on the display and the Temperature Ramp Pilot Light is lit, indicating that the temperature ramp is now activated.

### **3** Adjusting the Day Number

The current day number can be adjusted in order to move forward or backward on both ramps (temperature and minimum ventilation speed ramps) at the same time. Note that the current day is set to "OFF" if no ramp function is enabled.

- Set the function to **CURRENT RAMPING DAY**. The current day number is displayed, alternating with the letters "day".
- Use the adjustment knob to set the day number to the desired value.

### **4** Deactivating the Temperature Ramp

- Set the function to **SET POINT/TEMP RAMP**. The current temperature set point is displayed.
- Press the push-button to display the points of the ramp actually defined until the word **ON** appears (twenty-one clicks).
- Turn the adjustment knob counterclockwise one notch. The word **OFF** flashes on the display and the Temperature Ramp Pilot Light turns off indicating that the temperature ramp is now deactivated.

## VENTILATION SETTINGS

### Cooling Operation

The OVATION 113 controls one stage of variable-speed fans (Stage 1) and one stage of constant-speed fans (Stage 2).

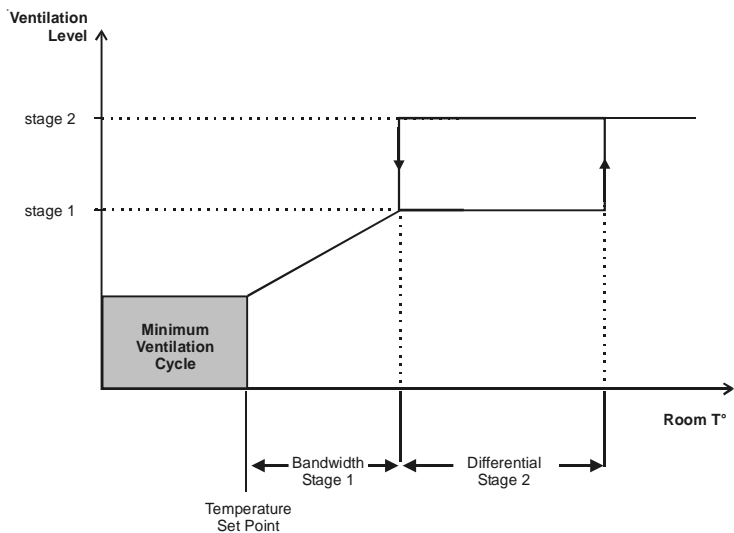

#### IF THE ROOM TEMPERATURE RISES:

- When room temperature < Set Point, stage 1 fans run at minimum speed according to the minimum ventilation cycle.
- At Set Point: stage 1 fans stop operating according to the minimum ventilation cycle and increase in speed as the room temperature rises.
- At Set Point + Bandwidth 1: stage 1 fans reach full speed.
- At Set Point + Bandwidth 1 + Differential 2: stage 2 fans start running.

## IF THE ROOM TEMPERATURE FALLS\*:

- At Set Point + Bandwidth 1: stage 2 fans return to a stop; and stage 1 fans start decreasing in speed as the temperature decreases.
- At Set Point: Stage 1 fans reach minimum speed.
- Below the Set Point: stage 1 fans stop operating continuously and operate according to the minimum ventilation cycle at minimum speed.

### \* USING A FIX HYSTERESIS ON VENTILATION STAGE 2:

This function allows deactivating stage 2 when the room temperature decreases of 2° F (1.1° C) below its differential. Set the internal switch #6 to ON to activate this function.

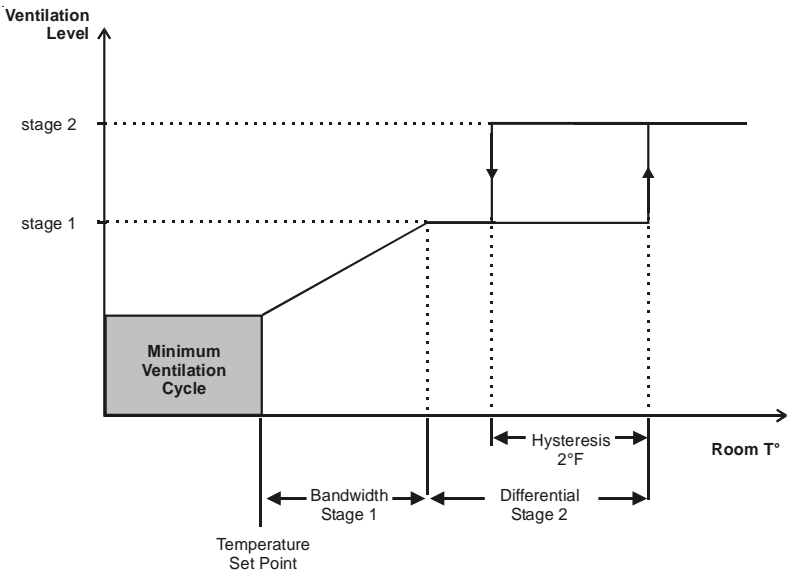

## Minimum Ventilation Cycle

When the room temperature is below the set point, the fans of stage 1 operate according to the minimum ventilation cycle. Running the fans even though ventilation is not required for a cooling purpose is useful to reduce humidity levels and supply oxygen to the room. It also prevents the fans from freezing in winter.

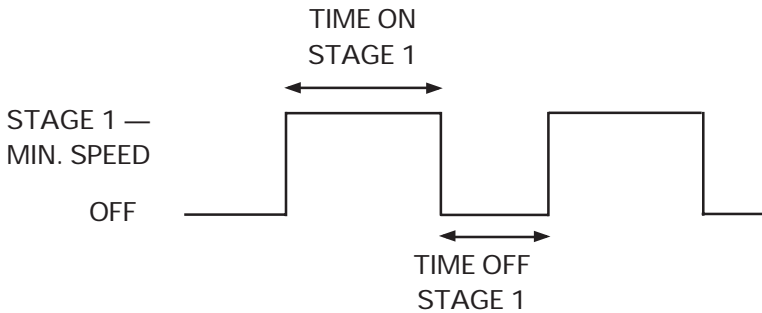

During the Time On, stage 1 fans run at their minimum speed and the pilot light of stage 1 is lit; during the Time Off, the fans return to a stop and the pilot light turns off. Note that the minimum speed of stage 1 can automatically be adjusted over time with a ramp (see below).

**NOTE:** The controller supplies maximum voltage to the variable-speed fans for 2 seconds immediately following each start-up.

## Minimum Ventilation Cycle Settings

1. To run the fans continuously at minimum speed, set the Time Off to zero and Time On to any value other than zero.
2. To stop the fans, set the Time On to zero and Time Off to any value.
3. To run the fans intermittently, set the Time On to the desired running time and Time Off to the desired off time.



## **1** Adjusting the Minimum Speed of Stage 1

The minimum speed can be adjusted between 10 and 100%.

- Set the function to **STAGE 1 MIN SPEED/RAMP**. The minimum speed of stage 1 flashes on the display, alternating with the letters "**SPEEd**".
- Use the adjustment knob to adjust the minimum speed to the desired value.

**NOTE:** This speed can only be adjusted if the minimum speed ramp is disabled (see Minimum Ventilation Ramp chapter).

## **2** Adjusting the Minimum Ventilation Timer

Time on and Time Off can be adjusted between 0 and 900 seconds, in increments of 15 seconds.

- Set the function to **STAGE 1 BANDWIDTH/TIMER**. The current bandwidth of stage 1 flashes on the display "**BAnd**".
- Press the push-button. The current Time On of stage 1 flashes on the display "**t. On**".
- Use the adjustment knob to adjust the Time On to the desired value.
- Press the push-button. The current Time Off of stage 1 flashes on the display "**t. Off**".
- Use the adjustment knob to adjust the Time Off to the desired value.

## Humidity Compensation

The minimum speed of stage 1 can automatically be adjusted as a function of relative humidity. As humidity increases, the minimum speed increases proportionally to compensate for the change. At humidity levels at or below the humidity set point, the minimum speed is equal to the normal uncompensated speed. The user specifies the percentage increase in minimum speed for a relative humidity equal to the humidity set point + 10%. For example, if the minimum speed is 40% and the compensation adjustment is 30%, the minimum speed will be adjusted to 70% of full speed when the humidity rises 10% above the humidity set point. In addition to adjusting the minimum speed, the humidity compensation feature also changes the operation of the minimum ventilation cycle: if the controller is operating in minimum ventilation mode when the relative humidity exceeds the humidity set point, the minimum ventilation fans are operated continuously rather than cycled.

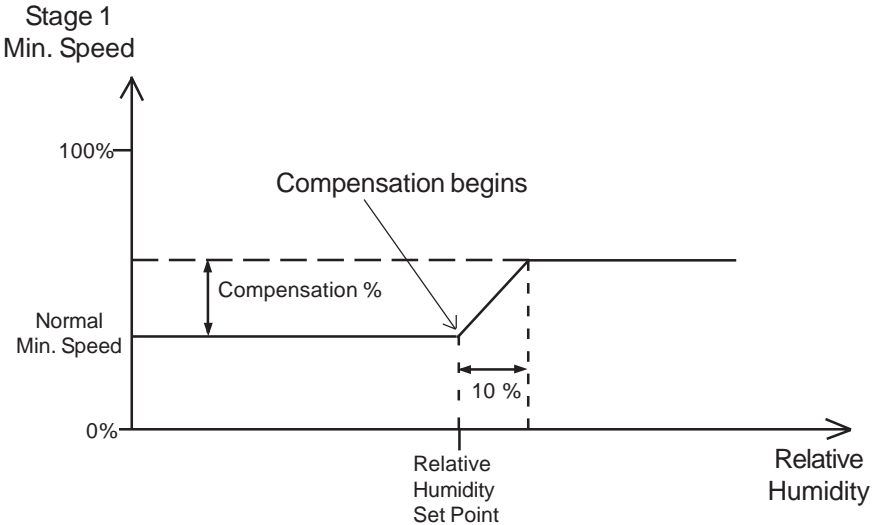

When a compensation is applied to the minimum speed, the compensation pilot light turns on.

## **1** Viewing the Relative Humidity

The relative humidity is expressed as a percentage.

- Set the function to **RELATIVE HUMIDITY MIN/MAX**. The current relative humidity is displayed.
- Turn the adjustment knob clockwise by one notch. The maximum humidity reading flashes on the display, alternating with the letters "rH Hi".
- Turn the adjustment knob counterclockwise one notch the current humidity level is displayed once again.
- Turn the adjustment knob counterclockwise one notch further. The minimum humidity reading flashes on the display, alternating with the letters "rH Lo".

**NOTE:** If you let the display flash for more than 10 seconds when the maximum or minimum humidity is displayed, the controller resets the minimum and maximum humidity values currently in memory (the display stops flashing to indicate that the reset has been done).

## **2** Adjusting the Relative Humidity Set Point

When the relative humidity exceeds the humidity set point, the minimum speed of stage 1 fans is increased by a proportional amount to compensate for the increase in humidity. Note that the humidity compensation feature must be activated for this to work.

- Set the function to **STAGE 1 RH COMPENSATION**. The relative humidity set point is displayed alternating with the letters "Set".
- Use the adjustment knob to adjust the set point to the desired value.

### 3 Adjusting the Minimum Speed Compensation

This is the increase in the minimum speed for a relative humidity equal to the humidity set point + 10%. It ranges from 0 to 100%.

- Set the function to **STAGE 1 RH COMPENSATION**. The relative humidity set point is displayed alternating with the letters "Set".
- Press the push-button. The current minimum speed compensation is displayed, alternating with the letters "SPEED".
- Use the adjustment knob to adjust the minimum speed compensation to the desired value.

### 4 Activating/Deactivating Humidity Compensation

- Set the function to **STAGE 1 RH COMPENSATION**. The relative humidity set point is displayed alternating with the letters "Set".
- Press the push-button twice. The current on/off state of humidity compensation flashes on the display.
- Use the adjustment knob to adjust the on/off state to the desired value.

## Minimum Ventilation Speed Ramp

The user can define a minimum ventilation speed ramp to adjust the minimum speed of stage 1 automatically over a given time period. A ramp is defined by ten points and each point specifies a day number and a fan speed for that day. Once the points are defined, the minimum speed ramp must be activated. When the minimum speed ramp is activated, the controller adjusts the minimum speed of state 1 fans every hour in a linear fashion between two consecutive points.

When the last point of the ramp is reached, the ramp is deactivated. The controller maintains the minimum speed specified for this point until the ramp is reactivated or until a new single minimum speed is specified using the first method.

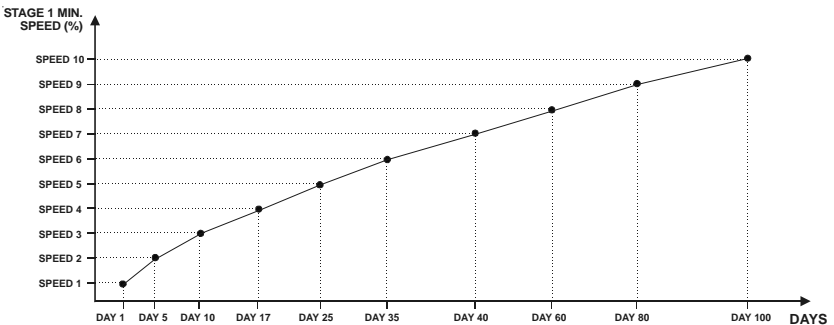

### NOTES:

- i) The minimum speed ramp must be deactivated before specifying the points on the ramp (see below).
- ii) All ten points of the ramp must be specified. If you do not need ten different points, repeat your last minimum speed for each unnecessary point of the ramp.
- iii) Certain restrictions apply to reduce the risk of errors:
  - decreasing minimum speeds are not allowed.
  - the min. speed variation cannot exceed 10% per day.

## 1 Specifying the Minimum Speed Ramp

The points of the ramp can only be modified while the ramp is disabled. Refer to the 4<sup>th</sup> section of this chapter to disable the ramp.

- Set the function to **STAGE 1 MIN SPEED/RAMP**. The current minimum speed of stage 1 flashes on the display – the value does not flash if the ramp is activated. Refer to the 4th section of this chapter to disable the ramp.

Repeat the following steps for each of the ten points (point 0 to point 9):

- Press the push-button. A day number is displayed, alternating with the word "dO x" (where "x" is the day number).
- Using the adjustment knob, set the day number of the first point of the ramp to the desired value.
- Press the push-button once again. The minimum speed of the first point (point 0) is displayed "PO x" where x represents the speed.
- Use the adjustment knob to adjust the minimum speed of the first point of the ramp to the desired value.

## 2 Activating Minimum Speed Ramp

If you have just finished specifying the points on the ramp:

- Press the push-button once again. The word **OFF** flashes on the display.
- Turn the adjustment knob clockwise by one notch. The word **ON** flashes on the display and the Minimum Speed Ramp Pilot Light turns on, indicating that the minimum speed ramp is now activated.

If you have previously specified the points on the ramp:

- Set the function to **STAGE 1 MIN SPEED/RAMP**. The current minimum speed flashes on the display.
- Press the push-button to display the points of the ramp currently defined until the word **OFF** appears (twenty-one clicks).
- Turn the adjustment knob clockwise by one notch. The word **ON** flashes on the display and the Minimum Speed Ramp Pilot Light turns on, indicating that the minimum speed ramp is now activated.

## 3 Adjusting the Day Number

The current day number can be adjusted in order to move forward or backward on both ramps (temperature and minimum ventilation speed ramps) at the same time. Note that the current day is set to "OFF" if no ramp function is enabled.

- Set the function to **CURRENT RAMPING DAY**. The current day number is displayed, alternating with the letters "day".
- Use the adjustment knob to set the day number to the desired value.

## 4 Deactivating Minimum Speed Ramp

- Set the function to **STAGE 1 MIN SPEED/RAMP**. The current minimum speed flashes on the display.
- Press the push-button to display the points of the ramp currently defined until the word **ON** appears (twenty-one clicks).
- Turn the adjustment knob counterclockwise by one notch. The word **OFF** flashes on the display. The Minimum Speed Ramp Pilot Light turns off, indicating that the minimum speed ramp is now deactivated.



## Differential Settings

Refer to the diagram at the beginning of the ventilation chapter for further information on the following parameters.

### 1 Adjusting the Bandwidth of Stage 1

The Stage 1 bandwidth is the temperature interval over which the speed of variable stage 1 fans increases or decreases proportionally to the temperature. The bandwidth can be adjusted between 0.5° F and 20.0° F (0.3° C and 11.1° C).

- Set the function to **STAGE 1 — BANDWIDTH/TIMER**. The current bandwidth of stage 1 flashes on the display, alternating with the letters "**BAnd**".
- Use the adjustment knob to adjust the bandwidth to the desired value.

### 2 Adjusting the Differential of Stage 2

The differential of stage 2 is the temperature difference from the moment stage 1 fans reach full speed and the moment stage 2 fans start running. It can be adjusted between 0.5° F and 20.0° F (0.3° C and 11.1° C).

- Set the function to **STAGES 2 DIFFERENTIAL**. The current differential of Stage 2 flashes on the display, alternating with the letters "**diF**".
- Use the adjustment knob to adjust it to the desired value.

## Mist Cooling

The controller controls 1 mist stage. The following graphic shows how this output operates:

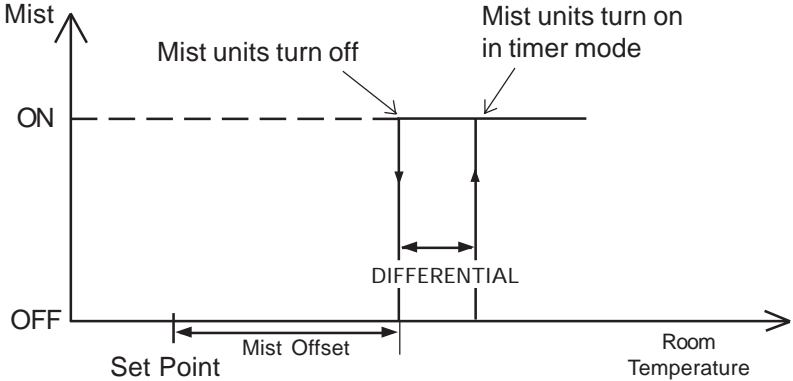

Mist units start running according to a timer cycle (Time On and Time Off) when their start temperature is reached (Set Point + Mist Offset + Differential).

If the humidity compensation is activated, the mist units are shut off when the humidity level is too high.

## **1** Adjusting the Mist Differential

The mist differential is the variation in room temperature between the moment the mist units turn on and the moment they turn off. It can be adjusted between 0.5° F and 20.0° F (0.3° C and 11.1° C).

- Set the function to **MIST OFFSET/DIFFERENTIAL**. The mist offset is displayed, alternating with the letters "**OFSEt**".
- Press the push-button. The mist differential is displayed, alternating with the letters "**dIF**",
- Using the adjustment knob, set the differential to the desired value.

## **2** Adjusting the Mist Offset

The mist offset is the temperature difference from the set point at which the mist units turn off. It can be adjusted between 0.5° F and 20.0° F (0.3° C and 11.1° C).

- Set the function to **MIST OFFSET/DIFFERENTIAL**. The mist offset is displayed, alternating with the letters "**OFSEt**".
- Using the adjustment knob, set the offset to the desired value.

## 3 Adjusting the Mist Timer Settings

The timer's On Time can be adjusted from 0 to 900 seconds, in increments of 15 seconds; the Off Time can be adjusted from 0 to 60 minutes. To deactivate mist cooling, set the Time On to zero.

- Set the function to **MIST TIMER**. The current Time On for the mist cycle is displayed, alternating with the letters "t On".
- Use the adjustment knob to set the Time On to the desired value (in minutes).
- Press the push-button. The current Time Off for the mist cycle is displayed, alternating with the letters "t Off".
- Use the adjustment knob to set the Time Off to the desired value (in minutes).

## 4 Adjusting the Mist Shutoff Set Point

The mist shutoff set point is the humidity level above which mist units are disabled. The mist shutoff value ranges from 0 to 100% of humidity. To disable this function, increase the parameter value until you reach the word "no".

- Set the function to **MIST RH COMPENSATION**. The humidity level above which mist units turn off is displayed, alternating with the letters "rH OFF".
- Use the adjustment knob to set the humidity level over which the mist stage stops operating.

## NATURAL VENTILATION

### Principle of Operation

The OVATION 113 controls one curtain output. The following graphic shows how this output operates:

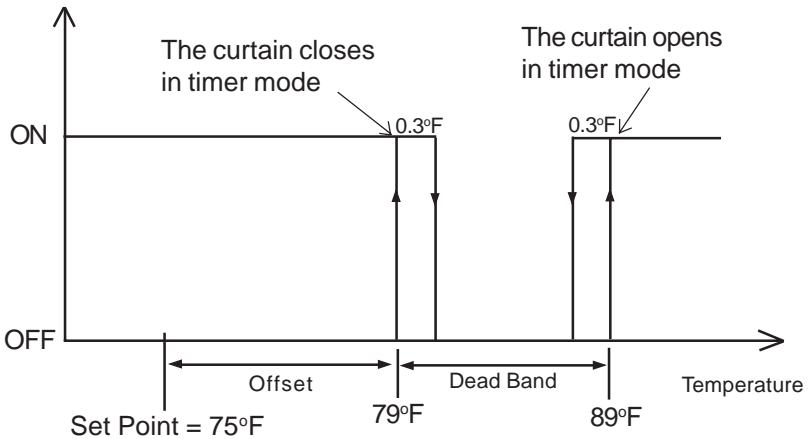

In the example above, when the temperature rises to 89°F, the curtain starts opening and continues to do so until fully open if the temperature remains above this point. If the temperature falls to 88.7°F, the curtain stops opening.

The curtain opens intermittently according to the time on and time off settings:

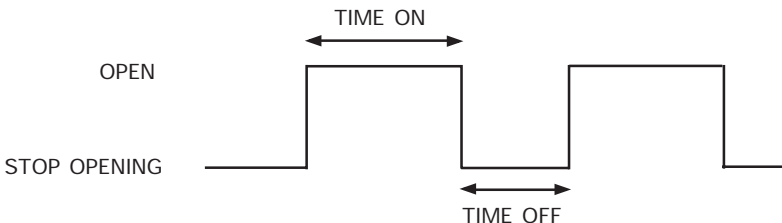

## OVATION 113

When the temperature falls to 79°F, the curtain starts closing and continues to do so until fully closed if the temperature remains below this point. If the temperature rises to 79.3°F, the curtain stops closing.

The curtain closes intermittently according to the time on and time off settings:

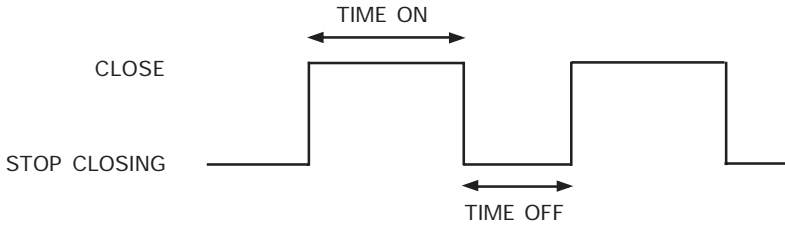

**CURTAIN OPERATING TIME COMPENSATION****1. Normal Mode (Without Compensation)**

The curtain opens and closes intermittently according to the specified opening time, closing time and time off, as described on the preceding pages. There is no outside temperature compensation.

**2. Progressive Mode (With Compensation)**

The controller can use the current outside temperature to adjust the opening and closing times of the curtain. This feature must be activated from the front panel (see below). An outdoor temperature probe must be connected to input #5 for this feature to work.

**Room Temperature Rises:** When the curtain opens, the controller increases TIME ON by 5% for every 1° F (0.6° C) difference between the outside temperature and the outside Set Point. The TIME OFF is decreased by the same amount. This is true if the outside temperature is greater than the outside set point.

The higher the outside temperature, the time on increases, causing the curtain to open faster.

**Room Temperature Falls:** When the curtain closes, the controller increases TIME ON by 5% for every 1° F (0.6° C) difference between the outside temperature and the outside Set Point. TIME OFF is decreased by the same amount. This is true if the outside temperature is lower than the outside set point.

The lower the outside temperature, time on increases, causing the curtain to close faster.

NOTE: If, after compensation, the time off value is less than or equal to ten seconds, it is set to zero.

## Settings

### 1 Manual Control of the Curtain

- Set the selection knob to **CURTAIN MANUAL MODE**. The status of the manual control mode of the curtain is displayed.
- Use the adjustment knob to select the manual mode status:
  - "AUt." to select the automatic control mode;
  - "OPn" to manually open the curtain (the letters " OPn" flash on the display for 5 seconds then the curtain starts opening);
  - "CLo" to manually close curtain (the letters "CLO" flash on the display for 5 seconds then the curtain starts closing);
  - "OFF" to stop the curtain's actuator.

### 2 Adjusting the Curtain Offset

The offset is the number of degrees, above the set point, at which the curtain starts closing in timer mode (refer to the previous graphic). It can be adjusted from 0.5 to 20.0° F (0.3 to 11.1° C) and must be greater than bandwidth 1.

- Set the selection knob to **CURTAIN — OFFSET/DEAD BAND**. The curtain offset flashes on the display, alternating with the letters "OFSEt".
- Use the adjustment knob to set the offset to the desired value.



### 3 Adjusting the Dead Band

The dead band is the temperature difference between the opening and closing temperatures of the curtain. The dead band can go from 0.5° F to 20.0° F (0.3° C to 11.1° C).

- Set the selection knob to **CURTAIN — OFFSET/DEAD BAND**. The curtain offset flashes on the display, alternating with the letters "OFSEt".
- Press the push-button. The dead band of the curtain flashes on the display, alternating with the letters "d.band".
- Use the adjustment knob to set the dead band to the desired value.

### 4 Adjusting the Curtain's Timer

The On time can be adjusted from 10 to 900 seconds; the Off time can be adjusted from 0 to 900 seconds in increments of 5 seconds.

- Set the selection knob to **CURTAIN — TIMER**. The ON time of the curtain's timer flashes on the display, alternating with the letters "t On".
- Use the adjustment knob to set the ON time to the desired value.
- Press the push-button. The OFF time is displayed, alternating with the letters "t OFF".
- Use the adjustment knob to set the OFF time to the desired value.

## 5 Adjusting the Outside Set Point

The outside set point is used for compensating curtain operating times as a function of outside temperature (see above). It can be adjusted between -40.0° F and 99.9° F (-40.0° C and 37.7° C).

- Set the selection knob to **OUTSIDE TEMP / SET POINT**. The current outside temperature is displayed.
- Press the push-button. The outside set point is displayed, alternating with the letters "SET".
- Use the adjustment knob to adjust the outside set point to the desired value.

## 6 Activating Outside Temperature Compensation

- Set the selection knob to **OUTSIDE TEMP / SET POINT**. The current outside temperature is displayed.
- Press the push-button twice. The current on/off status of the outside compensation feature is displayed.
- Use the adjustment knob to enable or disable the compensation function.

## HEATER SETTINGS

The controller controls one heating output. The following graphic shows how this output operates:

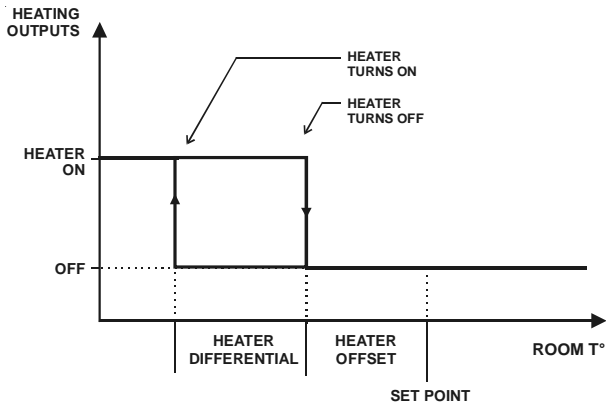

**If the room temperature rises:**

- at Set Point - Heater Offset: the heater turns off.

**If the room temperature falls:**

- at Set Point - Heater Offset - Heater Differential: the heater turns on.

## 1 Adjusting the Heater Offset

The heater offset can provide substantial energy savings if correctly adjusted according to the outside temperature. This offset represents the number of degrees below the set point at which the heating units turn off (see diagram above). It can be adjusted from -10°F to 20.0°F (-5.6°C to 11.1°C). If the offset is negative, the heating units will turn off at temperatures above the set point.

- Set selection knob to **HEATER OFFSET/DIFFERENTIAL**. The current heating offset is displayed, alternating with the letters "OFSEt".
- Use the adjustment knob to adjust the offset to the desired value.

## 2 Adjusting the Heating Differential

The heating differential is the temperature difference between the moment heating units turn on and the moment they turn off (see diagram above). It can be adjusted between 0.5° F and 20.0° F (0.3° C and 11.1° C).

- Set selection knob to **HEATER OFFSET/DIFFERENTIAL**. The current heating offset is displayed, alternating with the letters "OFSEt".
- Press the push-button. The differential is displayed, alternating with the letters "diF".
- Use the adjustment knob to adjust the differential to the desired value.

## ALARM SETTINGS

The controller sets off an alarm in the case of a power failure, a fault in the supply circuit or a high or low temperature. Temperature alarms are defined according to the set point as shown in the diagram below. The temperature alarm can either be set off if the average temperature exceeds the limits or if the reading of a single probe exceeds the limit.

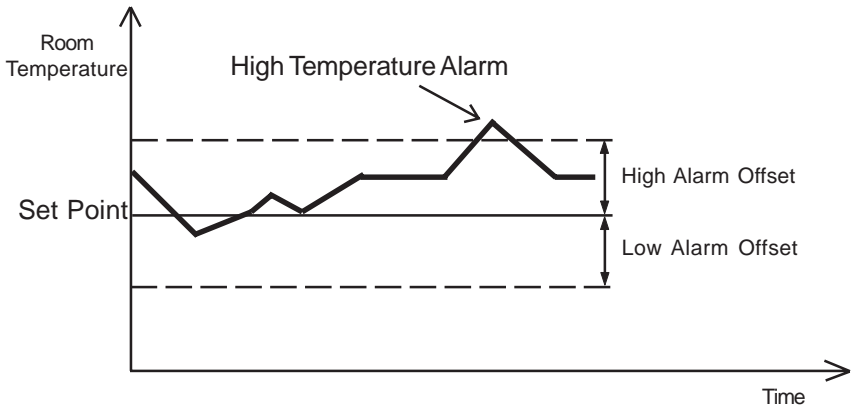

## Alarm Settings

The high and low alarm offsets range from 0.5° F to 40° F (0.3 to 22.2° C).

- Set the function to **ALARMS**. The current low alarm offset flashes on the display, alternating with the letters "LoAL". Use the adjustment knob to set it to the desired value.
- Press the push-button. The high alarm offset flashes on the display, alternating with the letters "HiAL". Use the adjustment knob to set it to the desired value.
- Press the push-button. The alarm type "TyPE" is displayed, alternating with the word "ALL" or "Ind".
- Use the adjustment knob to select "ALL" for an alarm to sound when the average temperature exceeds the defined high or low limits; select "Ind" for alarm to sound when the reading of an individual probe exceeds the high or low temperature limits.

## TEST MODE

A test mode allows you to simulate temperature changes and verify the performance of your controller. In test mode, the temperature probe inputs are turned off, allowing to change the temperature used by the controller to operate the stages. The controller operates as before using the new temperature settings.

### Enable / disable the test mode:

- Set the function to **TEST MODE**. The test mode status flashes on the display.
- Use the adjustment knob to select the desired test mode status (On or Off).

### Setting the test mode temperature:

- Once the test mode is enabled, press the push button. The test mode temperature is displayed, alternating with the letters "tSt".

**NOTE:** If no user activity is recorded after 4 minutes in test mode, the controller automatically exits from the test mode.

## TROUBLESHOOTING GUIDE

PROBLEM	CAUSE	SOLUTION
<p><b>The display doesn't work.</b></p>	<p>The circuit breaker on the service panel is off or tripped.</p> <p>The wiring is incorrect.</p> <p>The input fuse is open.</p> <p>The voltage selector switch is in the wrong position.</p> <p>The display board interconnect cable is unplugged from the power supply board.</p>	<p>Reset the circuit breaker.</p> <p>Fix the wiring.</p> <p>Replace the fuse.</p> <p>Set the switch to the correct position.</p> <p>Plug the cable.</p>
<p><b>The display shows the letter "P"</b></p>	<p>Probe # 1 is improperly connected.</p>	<p>Fix the probe's connection.</p>
<p><b>The Defective Probe Pilot Light is on.</b></p>	<p>One or more probes are defective.</p>	<p>Follow the procedure described in DEFECTIVE PROBES to identify and replace the defective probe.</p>
<p><b>The display shows sudden variations in room temperature.</b></p>	<p>A variation in resistance is induced on a probe.</p> <p>There is electrical noise near an extended probe cable.</p>	<p>Make sure the probes are dry and move them away from drafts and sources of radiant heating.</p> <p>Do not run probe cables next to other power cables. When crossing other power cables, cross at 90°.</p>



PROBLEM	CAUSE	SOLUTION
<p><b>Stage 1 fans are not running.</b></p>	<p>The wiring is incorrect.</p>	<p>Correct the wiring. In particular, make sure two different lines are connected to each motor: line L1 modulated by the controller should be combined with another line (N for 115V or L2 for 230V) to activate the motor. Also, be sure the Stage 1 and 2 COMMON is supplied by line L1.</p>
	<p>The Stage's fuse is open.</p>	<p>Replace the fuse.</p>
	<p>The display board interconnect cable is not plugged into the power supply board properly.</p>	<p>Make sure the cable is firmly plugged in with the tabs in place.</p>
	<p>The minimum speed is too low.</p>	<p>Adjust the minimum speed to a higher value.</p>
	<p>The fan motor is defective.</p>	<p>Check if motor is defective by connecting it to an alternate power supply. Replace the motor if it still doesn't operate.</p>
<p>The On time of stage 1 fans in minimum ventilation is set to zero.</p>	<p>Set the On Time to a value other than zero.</p>	

## OVATION 113

PROBLEM	CAUSE	SOLUTION
<p><b>Stage 1 fans run continuously at full speed.</b></p>	<p>The wiring is incorrect.</p> <p>The ambient temperature is above the set point.</p>	<p>Fix the wiring.</p> <p>Adjust the set point to the desired value.</p>
<p><b>Stage 1 fans run erratically.</b></p>	<p>The selected motor ramp is inappropriate.</p> <p>The differential is too small.</p> <p>The Time On or Time Off is too short.</p>	<p>Select an appropriate motor ramp.</p> <p>Adjust the differential to a higher value.</p> <p>Adjust the Time On or Time Off to a higher value.</p>
<p><b>Stage 1 fans do not stop running when the controller is operating in minimum ventilation cycle.</b></p>	<p>Time off is set to zero.</p> <p>The wiring is incorrect.</p> <p>Humidity compensation is activated and relative humidity exceeds set point.</p>	<p>Set the Time Off to a value other than zero.</p> <p>Correct the wiring. In particular, make sure two different lines are connected to each motor: line L1 modulated by the controller should be combined with another line (N for 115V or L2 for 230V) to activate the motor. Also, be sure the stage 1 COMMON is supplied by line L1.</p> <p>Adjust set point or deactivate compensation as required.</p>

PROBLEM	CAUSE	SOLUTION
<p><b>Stage 2 is not operating.</b></p>	<p>The Stage's fuse is open.</p> <p>The display board interconnect cable is not plugged into the power supply board properly.</p> <p>The wiring is incorrect.</p> <p>The fan motor or heating unit is defective.</p> <p>The controller is defective.</p>	<p>Replace the fuse.</p> <p>Make sure the cable is firmly plugged in with the tabs in place.</p> <p>Correct the wiring. In particular, make sure two different lines are connected to each motor: line L1 modulated by the controller should be combined with another line (N for 115V or L2 for 230V) to activate the motor or heating unit. Also, make sure the Stage COMMON is supplied by line L1.</p> <p>Verify if the motor or heating unit is defective by connecting it to an alternate power supply. Replace the motor or heating unit if it still is not operating.</p> <p>Listen to see if there is a clicking sound when the Stage's pilot light turns on. If there is no clicking sound, contact your distributor to repair the controller.</p>

## TECHNICAL SPECIFICATIONS

### OVATION 113 Supply:

- 115/230 VAC (-18%, +8%), 50/60Hz, L1 same phases as Stage 1 and 2, overload and overvoltage protection fuse F12-1A fast blow.

**Stage 1:** Variable output, 115 VAC (3/4 HP) / 230 VAC (1.5 HP), Mot.10A, 50/60 Hz, fuse F1-15A slow blow.

**Stage 2:** ON-OFF output, 115 / 230 VAC, 30VDC, 50 / 60 Hz, Mot.10A, heating or cooling, fuse F7-15A slow blow.

**Curtain output:** OPEN-CLOSE output, 115/230 VAC, 60 Hz, 30VDC, 5A winch output, fuse F3-5A slow blow.

**Heater 1:** 115 VAC (3/4 HP) / 230 VAC (1.5 HP), Mot.10A, 50/60 Hz, fuse F10-15A slow blow.

**Mist:** 115 VAC (3/4 HP) / 230 VAC (1.5 HP), Mot.10A, 50/60 Hz, fuse F9-15A slow blow.

**Alarm:** ON-OFF output, 3A, 115/230 VAC, 30VDC, fuse F11-3A slow blow.

**Probes:** Low voltage (< 5V), isolated from the supply. Operating range: -40.0°F to 120.0°F (-40.0°C to 48.9°C). Accuracy: 1.8°F (1°C) between 41°F and 95°F (5°C and 35°C).

**Enclosure:** ABS, moisture and dust-tight.

**The room temperature where the controller is located MUST ALWAYS REMAIN BETWEEN 32° AND 104° F (0° AND 40° C).**

## FACTORY SETTINGS

PARAMETER		FACTORY SETTINGS	RANGE OF VALUES
Temperature Set Point		75°F(23.9°C)	-40 to 120,0°F (-40 to 48.9°C)
Stage 1	Minimum Speed	40%	10 % to 100 %
	Time On	0 seconds	0 to 900 seconds in increments of 15 sec.
	Time Off	15 seconds	
	Bandwidth	2°F (1.1°C)	0.5 to 20°F (0.3 to 11.1°C)
Humidity Control	Humidity Set Point	65%	40 to 100%
	Compensation Percentage	60%	0 to 100% of stage 1 minimum speed
Stage 2	Differential	2°F (1.1°C)	0.5 to 20°F (0.3 to 11.1°C)
Curtain	Dead Band	2°F (1.1°C)	0.5 to 20 °F (0.3 to 11.1 °C)
	Time On	20 seconds	10 to 900 seconds
	Time Off	80 seconds	0 to 900 seconds
	Outside Set Point	70°F (21°C)	-40 to 99.9 °F (-40 to 37.7 °C)
Mist	Time On	60 seconds	0 to 900 seconds in increments of 15 sec.
	Time Off	10 minutes	0 to 720 minutes
	Offset	14°F (7.8°C)	0.5 to 20°F (0.3 to 11.1°C)
	Differential	2°F (1.1°C)	0.5 to 20°F (0.3 to 11.1°C)
	Mist Shut off humidity level	95%	0 to 100%
Heater	Heater Differential	2°F (1.1°C)	0.5 to 20°F (0.3 to 11.1°C)
	Heater Offset	2.0°F (1.1°C)	-10 to 20°F (-5.7 to 11.1°C)
Alarms	High Offset	12.0°F(6.7°C)	0.5 to 40°F (0.3 to 22.2°C)
	Low Offset	10.0°F(5.6°C)	0.5 to 40°F (0.3 to 22.2°C)



**NOTES:**

i) These initial parameter settings will not be retained in the controller's memory. Each new setting will replace the preceding one.

ii) If the power supply is cut off, the last parameter settings will be retained in memory until the power is restored.

## MEMORY CARD

The memory card is used to create a backup copy of your controller's configuration. The card is also useful to transfer the configuration of one controller to another controller of the same type.

The switch at the bottom of the card is used to lock or to unlock the card (  = locked,  = unlocked).

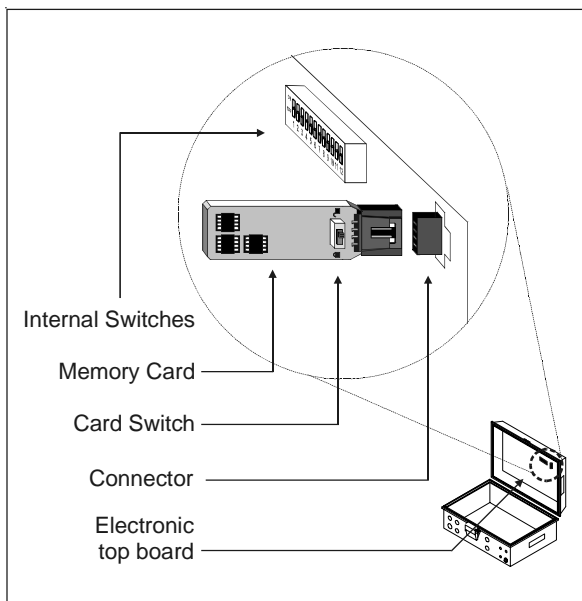

### TO TRANSFER A CONFIGURATION:

1. Open the latch and lift the controller's cover.
2. If you are about to copy the controller's configuration on the memory card, make sure the card's switch is at the unlocked position.

3. Insert the card in the connector located on the electric board inside the controller. Refer to the illustration above to position the memory card correctly.

4. If internal switch #12 is at the OFF position, simply switch it to the ON position; if internal switch #12 is at the ON position: return to the OFF position then switch it back to ON again.

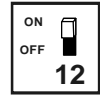

5. Close the controller's cover.

6. The transfer menu should be displayed on screen. Use the adjustment buttons to select whether you want to transfer the memory card's content into the controller ("**COPY**" "**to**" "**CTRL**") or if you wish to transfer the controller's content into the memory card ("**COPY**" "**to**" "**CARD**").

7. Once you have chosen the proper type of transfer, press and hold the Other Functions button for 5 seconds. The controller will automatically return to the **ROOM TEMP** menu once the transfer is completed. If the transfer is incorrect, the letters "**COPY**" and "**Error**" will flash on screen. In this case, turn the adjustment knob once to exit the error menu then refer to the table below to see possible error causes.

8. Once the transfer is over, open the controller's cover, and remove the memory card from the connector. Close the controller's enclosure afterwards.

9. Lock the card switch (  ) if required.

**Transfer Error:**

<b>CAUSE</b>	<b>SOLUTION</b>
The memory card is write protected	If you want to copy the controller's configuration on the memory card, make sure the switch at the bottom of the card is at the unlocked position.
The controller is write protected	If you want to transfer the card's configuration in the controller, make sure internal switch #1 of the controller is at the "OFF" position.
The memory card is blank or its content is incompatible with the controller	Make sure a valid configuration is written on the card before starting a transfer.
The transfer is incomplete	Make sure the memory card is properly inserted in the connector then retry the transfer. Do not move or hold the card while the transfer is ongoing.
	The memory card is defective, try with another card (contact your dealer).
	The connector is defective (contact you dealer).



## GLOSSARY

**BANDWIDTH:** The temperature interval over which the variable-speed fans of a given stage increase or decrease in speed proportionally to the temperature.

**CASCADING HEATERS:** Heaters operate in a sequence. As the average room temperature falls, additional heaters are turned on as needed.

**DEFAULT VALUE:** A typical parameter setting defined at the factory.

**DIFFERENTIAL:** The differential is the temperature difference between the moment the constant-speed fans or heating units of a given stage start running and the moment they return to a stop.

**MINIMUM VENTILATION CYCLE:** When the room temperature is below the set point, the Stage 1 fans operate intermittently to provide minimum ventilation to the room.

**MINIMUM VENTILATION SPEED RAMP:** When Stage 1 operates variable-speed fans, they will run at minimum speed during the minimum ventilation cycle. The user can define a minimum ventilation speed ramp to adjust the Stage 1 minimum speed automatically over a given time period. The minimum speed increases over time as the animals grow.

**OFFSET:** An offset is a temperature difference from the set point that normally defines a cut-off point for a stage operation. For example, a heater offset of 2° F means the heaters will turn off at 2° F below the set point.

**STAGE 1 RAMP:** When the temperature rises to the point where Stage 1 constant-speed fans are needed for cooling, the running time of the fans is increased gradually from the minimum ventilation settings up to full operation. Likewise, when the temperature falls below the set point, the running time is decreased gradually until the minimum ventilation settings are reached.

**SET POINT:** The set point is the target room temperature. When the temperature is above the set point, the controller cools the room by turning on the cooling fans. When the temperature is below the set point, the controller heats the room by turning on the heaters.

**TEMPERATURE RAMP:** The controller can be set to automatically change the temperature set point over a given period of time in accordance with the user's requirements. The set point decreases over time as the animals grow.

**ZONED HEATERS:** When zoned heaters are used, heaters in each zone operate according to their own probes rather than the average temperature for the entire room. In this way, heaters across zones are independent of one another.