



Smart Sense™

an Automatic Variable-Rate Heat Solution

Improves pig health and productivity through precise, even temperatures.

Smart Sense™ Technology for new and existing swine facilities.



SAVE
up to **35%**
on Heating Costs

*Field-Tested with Proven Results
(see details inside)*



Smart Sense™ Technology

A Difference You Can Feel

Smart Sense is a technologically-advanced swine facility heating solution. Our innovative heating technology eliminates the inefficiency of standard on/off controls. Smart Sense functions automatically through the facility control system to operate at maximum efficiency and provide:

- Fuel-cost savings up to 35%
- Consistent room temperature
- Enhanced animal welfare
- Better pig production
- Improved air quality

Smart Sense generates only the amount of heat required to reach, maintain, and hold a desired temperature by modulating Btu output. This is achieved through proprietary technology engineered for L.B. White forced air heaters and radiant-heat brooders.

Works with ventilation systems to provide consistent, even heat distribution

Heat On Demand

Smart Sense operates more efficiently because it automatically controls the heater Btu output to produce the amount of heat required to reach and maintain room temperature.

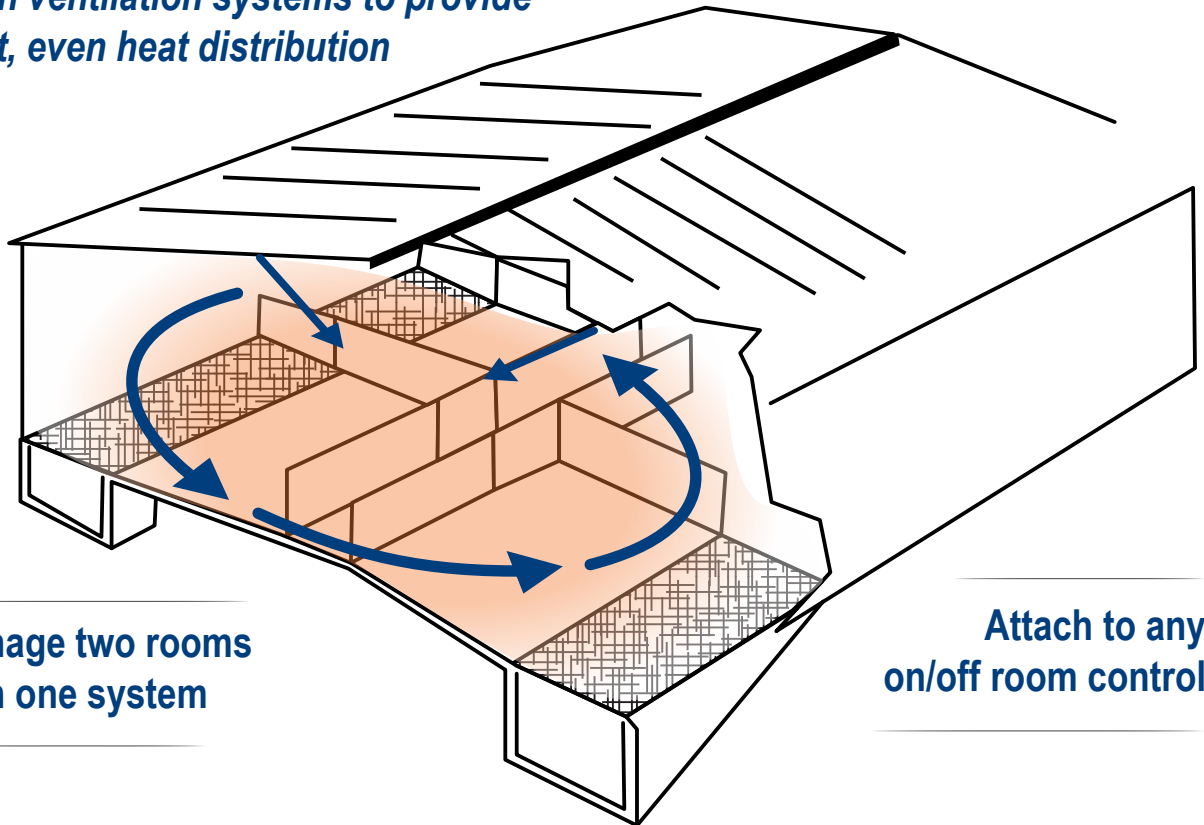

Manage two rooms with one system

Attach to any on/off room control

Manage Room Temperature Automatically

Don't React to the Room Environment—Control It!

Smart Sense automatically provides heat at only the rate required to reach a set point, and then maintains that temperature. This technology has been field tested across the upper Midwest with results that reflect significant increases in fuel-cost savings and pig development.

Actual Field Test Results

L.B. White Forced Air Heaters and Brooders

with Smart Sense Technology

COMPARED TO

with a Standard On/Off Control

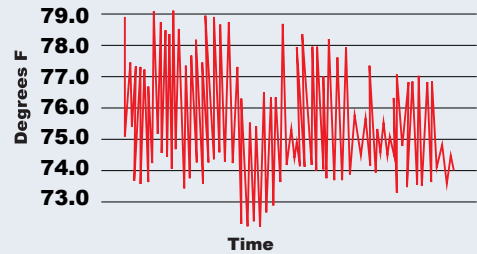
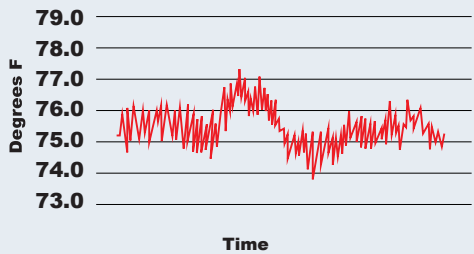

North Room	Wk 1	Wk 2	Wk 3
Avg. Low Temp.	75.83	74.42	73.57
Avg. High Temp.	77.00	75.71	75.00
Avg. Temp. Differential	1.16	1.28	1.42

South Room	Wk 1	Wk 2	Wk 3
Avg. Low Temp.	74.16	72.28	72.28
Avg. High Temp.	81.50	79.85	77.57
Avg. Temp. Differential	7.33	7.57	5.28

Note: All temperatures are recorded in degrees Fahrenheit.

Save up to 35% in Fuel Costs

Field studies have shown Smart Sense to be so efficient and effective at managing heat that payback on the system can be realized in as little as 1 year. **The results of the studies indicated a fuel-cost savings up to 35%!**

Test Site	Head Count	Fuel (gallons)	Cost of Fuel ¹	20% Savings	35% SAVINGS
Farm 1	2,400	6,300	\$10,080	\$2,016	\$3,528
Farm 2	2,400	13,800	\$22,080	\$4,416	\$7,728
Farm 3	1,200	3,600	\$5,760	\$1,152	\$2,016

1. \$1.60 per gallon at time of study. Payback results will vary by cost of fuel.





Smart Sense™ Applications

Maximize the Efficiency of Forced Air Heaters and Radiant-Heat Brooders

Supplemental heat and precise temperature management is essential for successful pig immunity development. See how Smart Sense in L.B. White Guardian with Smart Sense Forced Air Heaters and I-17 Infraconic Radiant-Heat Brooders enhance pig performance during critical stages of animal growth.

Wean-to-Finish Application

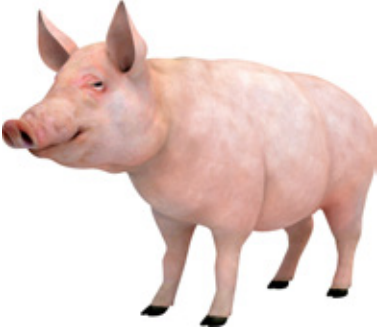
<p>Day 1 to Day 14</p> <p>Guardian with Smart Sense Forced Air Heater temperature set to 74°F.</p> <p>I-17 Radiant-Heat Brooder temperature set at 90°F and ramped down to 74°F.</p>	
<p>Day 14 to Day 45</p> <p>Guardian with Smart Sense Forced Air Heater temperature ramped down to 70-72°F.</p> <p>I-17 Radiant-Heat Brooder turned off.</p>	
<p>Day 45 to Maturity</p> <p>Guardian with Smart Sense Forced Air Heater temperature ramped down by 1°F per week. Hold temperature steady when temperature reaches 63-65°F.</p> <p>I-17 Radiant-Heat Brooder turned off.</p>	

Smart Sense™

Engineered to Save

Farrowing, Nursery, and Finisher Applications

Single Room or Two Rooms on Same Schedule

- SmartBox model FA-MCS or model FA-MCS-D
- Guardian with Smart Sense heaters (up to 2 per room)¹

1. For 3 or 4 heaters in a room, an Extension Box with sensors (model FA-EX) is available.



An L.B. White Guardian with Smart Sense installed in a nursery.

Smart Sense Control Configurations

L.B. White Controlled Forced Air Heaters and Zone-Panel Brooder

Forced Air Heater	Guardian with Smart Sense (up to 2 per room) ¹
Radiant Heater	Standard I-17 Brooders (1 zone) ^{2,3}
SmartBox™ Control	Model # COMBO-MCS (1 per room)

1. For 3 or 4 heaters in a room, an Extension Box with sensors (model FA-EX) is available.
2. For manual ignition specify 500-28564 zone control kit (24 brooder capacity)
3. For spark ignition specify 500-28580 zone control kit (24 brooder capacity)

L.B. White Controlled Forced Air Heaters and Independent Brooders

Forced Air Heater	Guardian with Smart Sense for 2 rooms) ^{1,2}
Radiant Heater	Standard I-17 Brooders ³
SmartBox™ Control	Model # FA-MCS-D (controls 2 rooms)

1. Can be run on the same schedule or on different schedules.
2. For 3 or 4 heaters in a room, an Extension Box with sensors (model FA-EX) is available.
3. Requires a zone control kit

OEM Control Options

I-17 manual ignition for OEM 0-10V control, model 500-28543

- 24 brooder capacity
- Panel with solenoid valve, control module, power supply, and sensor bracket

I-17 spark ignition for OEM 0-10V control, model 500-26487

- 24 brooder capacity
- Solenoid valve, control module, power supply, sensor bracket

I-17 manual ignition OEM on/off controls

- Low-High Zone
 - Medium capacity (20 brooders)
 - Model 500-09958
 - High capacity (40 brooders)
 - Model 500-09959
- Low-Medium-High Zone
 - Medium capacity (20 brooders)
 - Model 500-09875-B
 - High capacity (40 brooders)
 - Model 500-22553

Smart Sense™

Engineered to Save

Infraconic with Smart Sense™ Radiant-Heat Brooder

L.B. White Smart Sense™ technology provides the ability to set and manage temperatures at pig level independently of the ambient room temperature.

Gain control of the pig-occupied zone with Smart Sense versus 3-stage or hi-lo control panels that are not controlled by precision-based technology.

- Both standard manual and spark ignition I-17 brooders function with Smart Sense
- Requires sensor mounting kits for existing and new installations
- Operates with an existing 0-10 vdc control or with the SmartBox™ controller

Less Day-to-Day Management

than manual-set zone panels



The Smart Sense sensor with mounting bracket eliminates variation in sensor location and provides consistent, even temperatures between zones, and room to room.

Smart Sensors Setting the Industry Standard for Precision-based Heating

The L.B. White Smart Sense Sensor is a critical component in our variable-rate heat technology. Our sensors are not restricted by a shield or isolator, and are less sensitive to wire length or gauge. Combined with proprietary control logic, the sensor is always locked into position by a bracket to achieve precise results based on suggested protocols and a desired swine pattern.



SmartBox™ The Smart Sense Control Module

Smart Sense temperature control utilizes a programmable “smart” control logic that makes precise temperature control possible. Comes with wiring diagrams and directions.

- Three available configurations:
 - FA-MCS (Forced Air) for 1 or 2 rooms on the same schedule—up to 10 events
 - FA-MCS-D (Forced Air) for 2 rooms on different schedules—up to 6 events
 - Combo-MCS (Forced Air and Brooder) for 1 room—up to 10 events
- Displays:
 - % output
 - Input temperatures
 - Temperature set points
- Self-contained:
 - All signal conditioning, power supplies, and relays
 - Touch-pad programming
 - Micro-processor
 - NEMA 4X enclosure

Smart Sense™

Automatic Variable-Rate Heat Technology

- Saves up to 35% in fuel costs
- Enhances pig production
- Improves air quality and controls room temperature
- Reduces day-to-day management

L.B. White Forced Air Heaters and Brooders with Smart Sense



Engineered to Save Money and Improve Productivity



www.lbwhite.com
(800) 345-7200
W6636 L.B. White Rd.,
Onalaska, WI 54650

©2012 L.B. White Co. All Rights Reserved.

About L.B. White

For more than 60 years, L.B. White has been setting the standard in swine confinement heating. Today, L.B. White is proud to be the exclusive provider of automated variable-rate heat for both forced-air box heaters and brooders with patent-pending Smart Sense™ technology.