

Modulating Gas Valve

Models MG1, MG5 and MG20

Installation and Operation Manual



The Raydot logo is a trademark of Raydot, LLC.

Copyright © 2001 Blue Earth Research, LLC. All rights reserved.

Printed in the USA

Patent Pending

ENVIRONMENTAL PRODUCTS WARRANTY

PLEASE READ THIS WARRANTY CAREFULLY. IF YOU (THE PURCHASER) DO NOT AGREE WITH THE WARRANTY LIMITATIONS OR ITS TERMS AND CONDITIONS, PROMPTLY RETURN THIS PRODUCT, UNUSED, TO THE PLACE WHERE YOU OBTAINED IT FOR A FULL REFUND.

LIMITED WARRANTY: Blue Earth Research, LLC. (hereinafter BEaR) warrants this Product to be free from defects in material and workmanship and agrees to repair or replace any Product which proves defective under these terms and conditions.

IMPROVEMENTS: BEaR reserves the right to alter or improve this Product without notice and without incurring obligation to alter or improve existing Products.

LENGTH OF WARRANTY: This Product is warranted for a period of twelve (12) months from the date of installation. Sensors are warranted for a period of twelve (12) months from the date of manufacture or six (6) months from the date of installation.

WHO IS PROTECTED: This warranty is valid only for the original installation and is not transferable.

WHAT IS NOT COVERED: The following are not covered by this warranty:

- 1) Damage, deterioration or malfunction resulting from, but not limited to: power fluctuations or surges, accident, misuse, abuse, neglect, fire, water, corrosion, lightning or other acts of nature, improper storage, unauthorized Product repair or modification, damage in shipment, removal or installation of this Product, or any other cause not related to a Product defect.
- 2) Cartons, batteries, and other accessories used in connection with this Product.
- 3) Product returned without customer identification.
- 4) Service required as a result of third party components.

WHAT IS NOT REIMBURSABLE: The following items are not reimbursable:

- 1) Troubleshooting, removal or installation charges.
- 2) Setup, calibration, adjustment or maintenance of this Product.
- 3) Shipping and insurance charges for returning this Product to BEaR.
- 4) Customer training.
- 5) Travel expenses.

HOW TO GET WARRANTY SERVICE: You have the option of having your dealer replace/exchange any defective Product or returning this Product freight prepaid and insured to BEaR. All Product returned to BEaR must have customer identification attached.

CONSUMER CAUTION: System configuration, software, operator control of the system, and the application, among other things, will affect this Product's performance. While this Product is considered compatible with its intended purpose, the specific functional implementation by the customers of this Product may vary. The responsibility for using this Product and programming it to achieve the intended purpose, is the sole responsibility of the Purchaser.

LIMITATION OF DAMAGES AND IMPLIED WARRANTIES:

BEaR'S SOLE LIABILITY UNDER THIS WARRANTY AND PURCHASER'S EXCLUSIVE REMEDY FOR ANY DEFECTIVE PRODUCT, IS LIMITED TO THE REPAIR OR REPLACEMENT OF THIS PRODUCT, AT BEaR'S OPTION. IN THE EVENT BEaR CANNOT DO EITHER, THEN THE PURCHASER'S ALTERNATIVE EXCLUSIVE REMEDY SHALL BE A REFUND OF THE PURCHASE PRICE IN EXCHANGE FOR THE RETURN OF THE DEFECTIVE PRODUCT TO THE PLACE OF PURCHASE. BEaR SHALL NOT BE LIABLE FOR:

- 1) **DAMAGE TO OTHER PROPERTY CAUSED BY ANY DEFECTS IN THIS PRODUCT, INCLUDING BUT NOT LIMITED TO DAMAGES BASED UPON INCONVENIENCE, LOSS OF USE OF THIS PRODUCT, LOSS OF TIME OR DATA, OR ANY OTHER LOSS.**
- 2) **ANY OTHER DAMAGES, WHETHER INCIDENTAL, CONSEQUENTIAL, OR OTHERWISE FROM USE OR INABILITY TO USE THIS PRODUCT.**

THIS WARRANTY IS EXCLUSIVE AND IS IN LIEU OF ALL OTHER WARRANTIES, EXPRESS OR IMPLIED, INCLUDING, BUT NOT LIMITED TO, THE IMPLIED WARRANTIES OF MERCHANTABILITY OR FITNESS FOR A PARTICULAR PURPOSE. SOME STATES DO NOT ALLOW THE EXCLUSION OF IMPLIED WARRANTIES OR THE LIMITATION OR EXCLUSION OF LIABILITY FOR INCIDENTAL OR CONSEQUENTIAL DAMAGES. THEREFORE, THE ABOVE EXCLUSIONS OR LIMITATIONS MAY NOT APPLY TO YOU.

THIS WARRANTY GIVES YOU SPECIFIC LEGAL RIGHTS, AND YOU MAY ALSO HAVE OTHER RIGHTS WHICH VARY FROM STATE TO STATE IN THE UNITED STATES OF AMERICA.

PURCHASER AGREES THAT THE SALE OF THIS PRODUCT BEARS A REASONABLE RELATIONSHIP TO THE STATE OF MINNESOTA AND THE LAWS OF THE STATE OF MINNESOTA SHALL GOVERN THE VALIDITY, CONSTRUCTION AND ENFORCEABILITY OF THIS WARRANTY, WITHOUT GIVING EFFECT TO THE CONFLICT OF LAWS PRINCIPLES THEREOF.

THE PURCHASER OF THIS PRODUCT AGREES THAT ALL CLAIMS BROUGHT IN RESPECT OF THIS WARRANTY SHALL BE BROUGHT IN A COURT LOCATED IN THE STATE OF MINNESOTA.

Table of Contents

SAFEGUARDS	2
OVERVIEW	3
Component Description	4
Model Variations	4
INSTALLATION AND WIRING	5
Step 1: Ignition Control Devices.....	6
Step 2: Input Options	7
<i>Input Option 1 – Thermostat or Switched Output (On/Off)</i>	7
<i>Input Option 2 - Analog Voltage Control</i>	8
Step 3: Pressure Control Valve.....	8
Step 4: Power Transformer	9
Step 5: Apply Gas Pressure.....	9
Step 6: Calibration	10
<i>Set Minimum Pressure Limit</i>	10
<i>Set Maximum Pressure Limit</i>	10
OPERATION	11
Startup (Warm Up Procedure)	11
Toggle Switch Settings	11
Response Time Settings.....	11
Reset to Factory Default	11
Status Indicator	12
TROUBLESHOOTING	13
SPECIFICATIONS.....	14
SERVICE.....	14

Safeguards

AS WITH ANY SOPHISTICATED CONTROL SYSTEM, THIS CONTROLLER CANNOT BE GUARANTEED TO PERFORM WITHOUT INCIDENT FOREVER. THERE ARE MANY CONDITIONS SUCH AS LIGHTNING STRIKES, PROGRAMMING ERRORS, AND EQUIPMENT FAILURE THAT COULD RESULT IN THIS CONTROLLER FAILING TO PERFORM ITS INTENDED FUNCTION. YOU MUST BE AWARE OF THIS AND BE WILLING TO TAKE THE NECESSARY PRECAUTIONS TO PREVENT FINANCIAL LOSS.

TO PROTECT AGAINST LOSS RELATED TO THE FAILURE OR MALFUNCTION OF THIS CONTROLLER, THE FOLLOWING SAFEGUARDS ARE REQUIRED:

1. A MANUAL BACKUP SYSTEM MUST BE INSTALLED. THIS SYSTEM MUST TAKE OVER IN THE EVENT OF A CONTROL SYSTEM MALFUNCTION.
2. AN ALARM SYSTEM MUST BE INSTALLED. THIS SYSTEM MUST PROVIDE A VISUAL INDICATION AND AUDIBLE WARNING OF ABNORMAL CONDITIONS.
3. A WEEKLY TEST OF THE MANUAL BACKUP SYSTEM AND ALARM SYSTEM MUST BE PERFORMED. THIS TEST CONFIRMS THAT THESE SYSTEMS ARE FUNCTIONING PROPERLY.
4. A DAILY CHECK OF THE CONTROL SYSTEM MUST BE PERFORMED. THIS CHECK CONFIRMS THAT THE SYSTEM IS OPERATING PROPERLY.
5. NON-FUNCTIONAL ALARM OR BACKUP SYSTEM COMPONENTS MUST BE REPAIRED IMMEDIATELY.

Overview

The modulating gas valve was developed to overcome the temperature fluctuation associated with traditional on/off heat controls. Traditional controls simply turn gas heaters on and off based on a setpoint temperature. The modulating gas valve regulates the flow of gas to achieve nearly constant temperature control.

The modulating gas valve's control unit contains a microprocessor that monitors the thermostat (or other temperature control device) and the gas pressure going to the heaters. When more heat is needed, gas pressure is gradually increased. When less heat is needed, gas pressure is reduced.

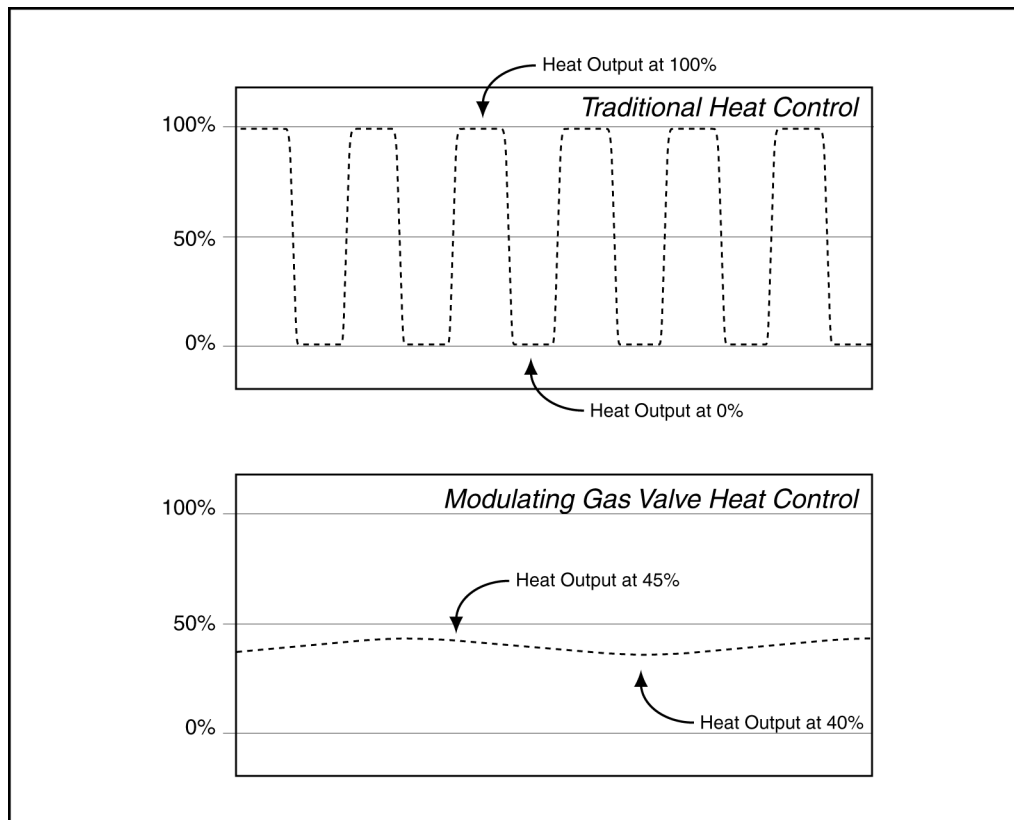

The modulating gas valve can operate using a simple ON/OFF thermostat. It can also use an ON/OFF relay or variable control voltage (0 to 10 volts DC) from an environmental control system. An environmental control system provides the most options for controlling the modulating gas valve. Most control systems:

- Allow the desired temperature (setpoint) to be automatically adjusted over a period of time.
- Disable heaters when curtains are open.
- Provide highly-accurate and reliable temperature readings and device control.

Component Description

The modulating gas valve is available in many configurations to meet a variety of needs. All configurations contain a minimum of a control unit, pressure sensor, and pressure control valve.

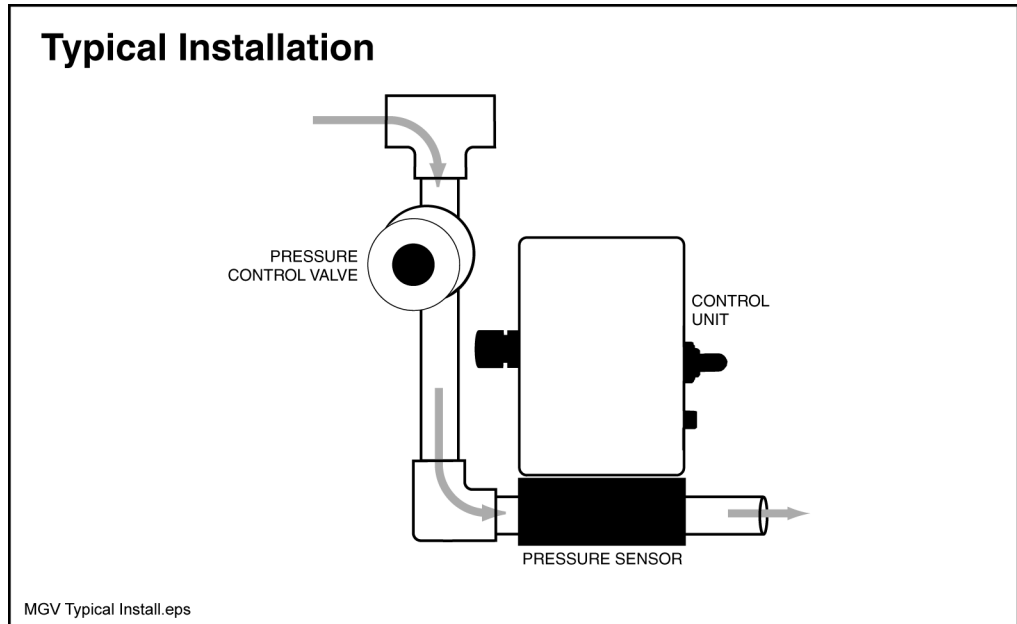

Control Unit - The control unit contains a microprocessor that monitors the thermostat (or other temperature control device) and output gas pressure. When more heat is needed, gas pressure is increased. When less heat is needed, gas pressure is reduced.

Pressure Sensor - The pressure sensor measures the gas pressure going to the heaters.

Pressure Control Valve (Heat Motor) - The control unit adjusts the pressure control valve to regulate the flow of gas to the heaters.

Model Variations



The modulating gas valve is available in models for different input gas pressures (11" water column, 5 psi or 20 psi). Be sure that the model purchased is appropriate for the gas pressure used in the building.

Installation and Wiring



A qualified person must install the modulating gas valve. Improper installation may result in damage to the unit and the building. Be sure to take the appropriate steps to check for gas leaks.

Install the pressure control valve so that it precedes the control unit/pressure sensor assembly (refer to illustration on previous page).

Install the control unit in an area where:

- The temperature will remain between 32 degrees Fahrenheit (0 degrees Celsius) and 110 degrees Fahrenheit (43 degrees Celsius).
- It is away from motors and relays/contactors that switch high current.
- The connecting wiring from an environmental control system (if applicable) will not exceed 2000 feet.

Never connect or disconnect wires while the power is on. The warranty does not cover damage caused by improper handling. Always touch a grounded surface before working on electronic equipment. Static shocks can destroy sensitive electronic circuits.

The control unit is wired with a nine-conductor cable. All of the connections are made to this cable. An optional junction box with terminal strip is available to simplify wiring and to protect the connections. The steps in this manual assume the use of a junction box and terminal strip.

Route the control unit cable into the junction box (you may need to drill holes) and attach the leads to the terminal strip. A color code guide is provided on the terminal strip circuit board. If the modulating gas valve assembly was shipped pre-mounted on a panel, the junction box wiring is already complete.

Connect the thermostat (or other temperature control device), 24VAC, ignition control devices, and pressure control valve leads to the junction-box terminal strip using the color code guide shown below. Wiring details are provided on the following pages.

Color	Connection
White	Ignition
Purple	Ignition
Yellow	Volts - (Analog Control)
Green	Common / Volts + (Analog Control)
Orange	Heat
Brown	Pressure Control Valve
Blue	Pressure Control Valve
Black	24VAC
Red	24VAC

Step 1: Ignition Control Devices

Ignition control devices can be attached to the ignition connections inside the junction box. These connections are only needed if the heaters require ignition when starting from the minimum gas pressure. Skip to the next section if ignition devices are not used.

The ignition connections act as an ON/OFF switch capable of handling 24VDC at 1 Amp. The control unit does not supply any voltage through these connections.

Move DIP switch 6 to the OFF position to enable the ignition relay.

DIP Switch Block Location

Control Unit
Circuit Board

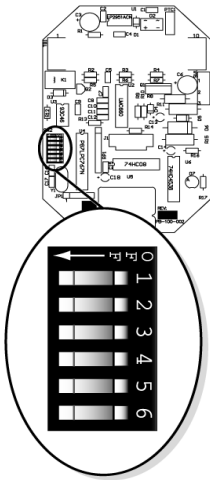

Ignition Relay	Switch 6
Enabled	OFF
Disabled	ON

The status indicator is red when the ignition relay is closed.

The control unit's ignition relay closes (turns on) when the thermostat (or other temperature control device) calls for heat. The ignition relay opens (turns off) when the control unit determines gas pressure has been at the minimum level for 10 minutes. The ignition relay is typically used to control igniters and solenoid-driven gas valves.

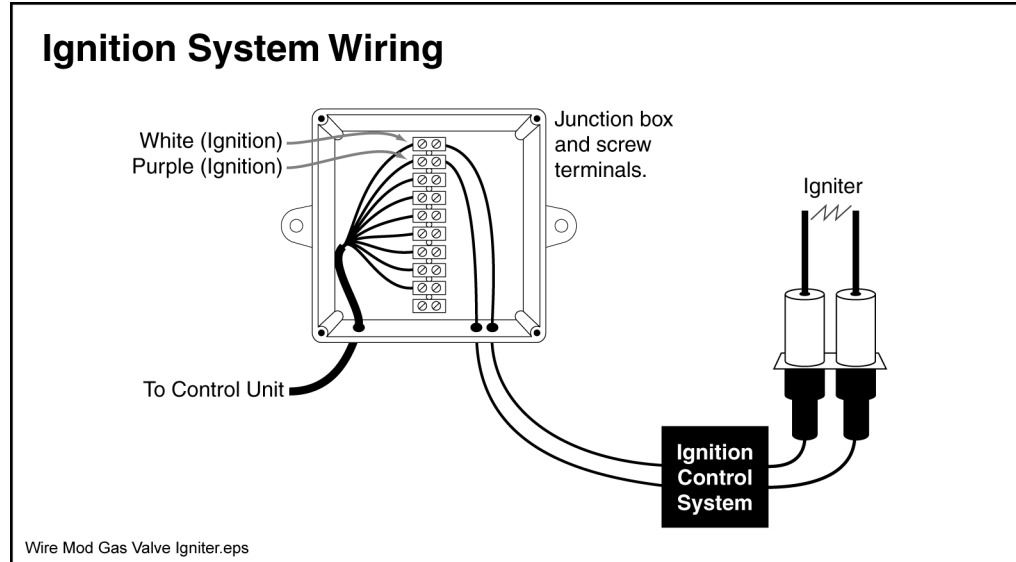

Each time power is applied to the control unit, there is a 15 minute delay before the ignition relay closes (turns on). The delay gives the pressure control valve time to fully open. The delay does not occur if the ignition relay is disabled.

Step 2: Input Options

DIP Switch Block Location

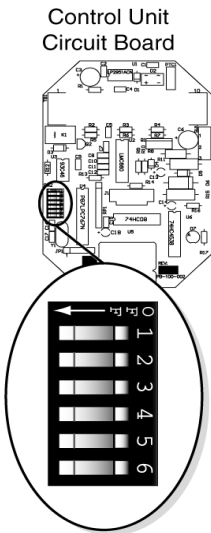

Move DIP switch 5 to ON or OFF depending on the type of temperature control device used.

Temperature Control Device	Switch 5
Simple ON/OFF thermostat	OFF
ON/OFF relay from an environmental control system	OFF
Variable control voltage (0 to 10 volts DC)	ON

Input Option 1 – Thermostat or Switched Output (On/Off)

Attach a thermostat or environmental control system's switched output to provide a heat ON/OFF command to the control unit. If a switched output is used, it should turn on (close the circuit) when the air temperature is at or below the point where heat is needed.

Thermostat or Switched Output (On/Off) Wiring

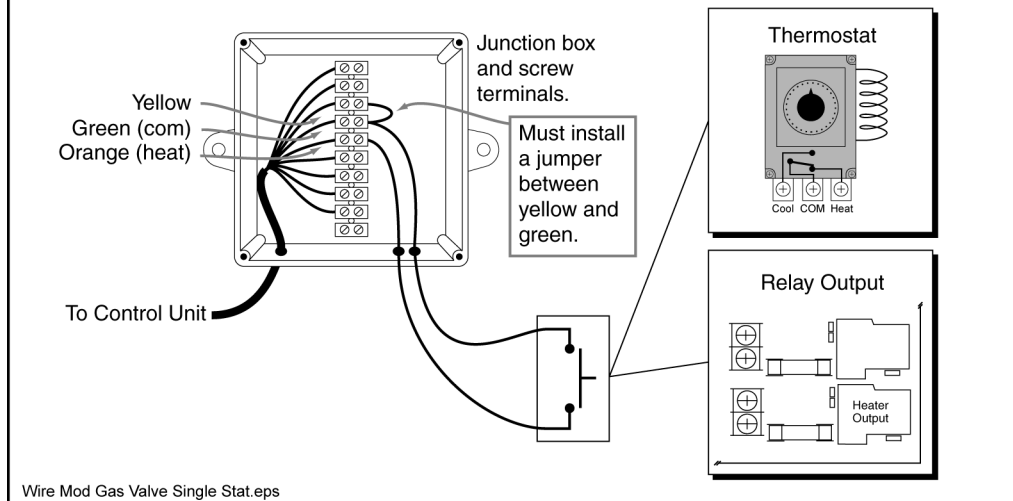

Input Option 2 - Analog Voltage Control

Some environmental control systems provide a 0 to 10 VDC output for controlling electronic valves. The modulating gas valve control unit can use this control voltage to proportionally adjust the gas pressure.

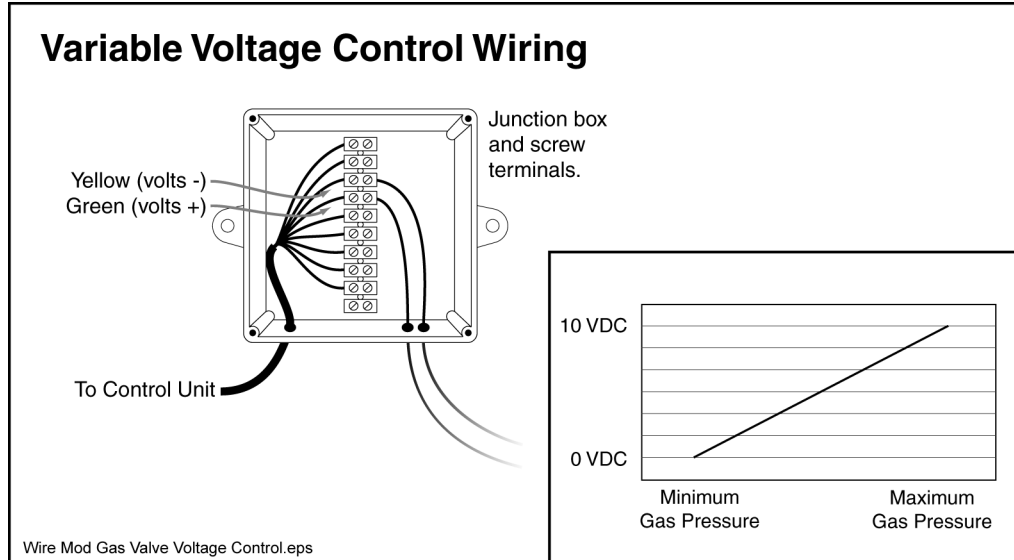

Step 3: Pressure Control Valve

Connect the pressure control valve wires to the proper wires from the control unit.

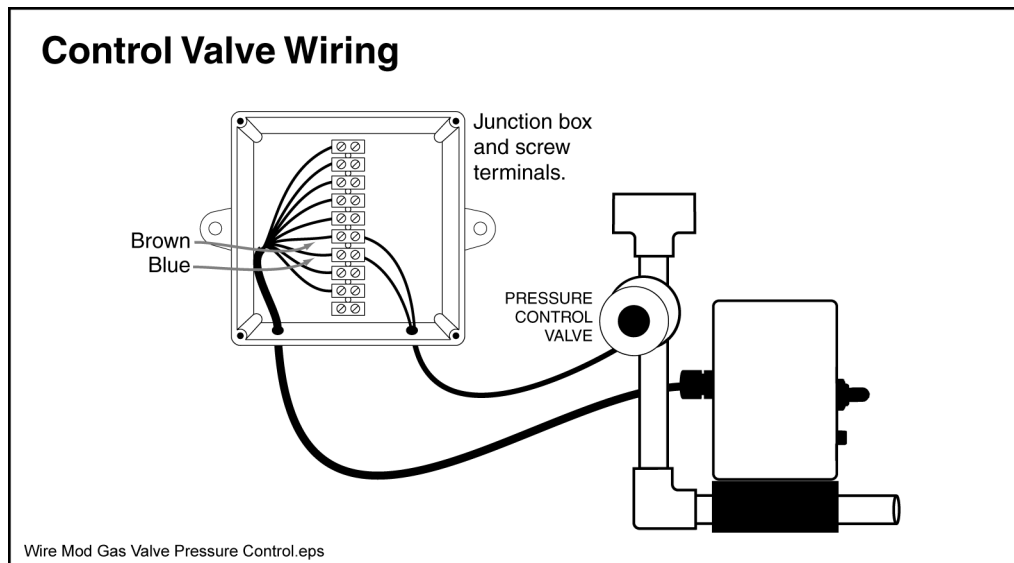

The pressure control valve closes during a power interruption. Some control unit failures may also cause the pressure control valve to close.

Step 4: Power Transformer

The modulating gas valve control unit operates on 24VAC 50/60 Hz. An optional class II power transformer is available to operate up to four units.

Do not apply power to the control unit until after all of the wiring is complete.

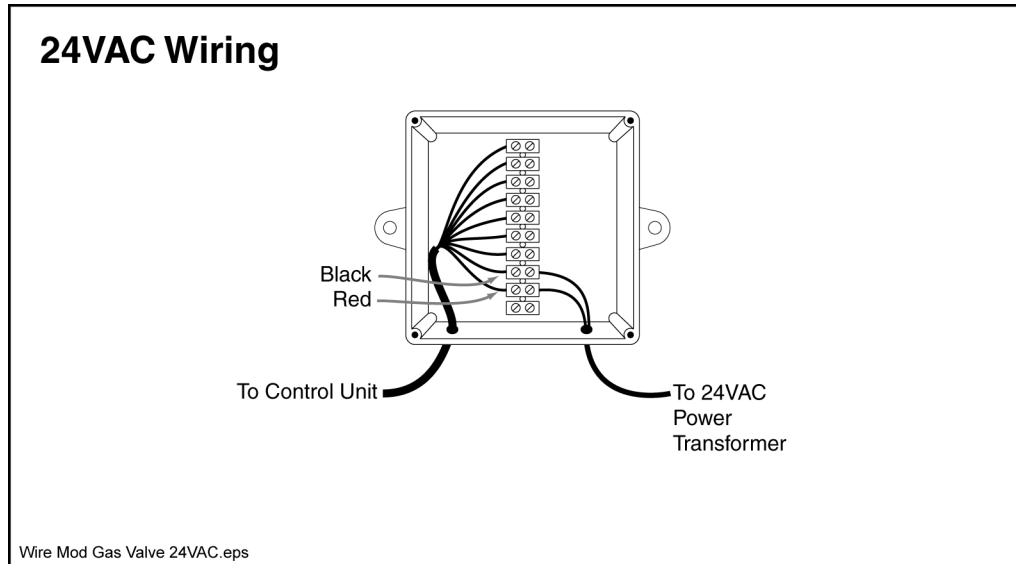

Step 5: Apply Gas Pressure

Turn on the gas source, check for leaks and verify the modulating gas valve is receiving the appropriate gas pressure.

Step 6: Calibration

Step #1

Toggle is off.

The gas is turned on.

Switches from 1 to 5 are off

Dipswitch 6 is on.

Move Dipswitch 3 to ON,

Move TOGGLE switch to auto, the light blinks once when the light turns off.

Move Dipswitch to the OFF position.

The light at this point will be blinking rapidly. After a short delay, the warm-up process is started. You will see the pressure go from your minimum to max, as soon as you see the solid light minimum calibration has been stored.

Step#2

Toggle is off

Turn dipswitch 4 to the ON position.

Move Toggle to auto, the light blinks once.

You see the pressure go from low to Max, when pressure has stabilized move dipswitch 4 to the off position.

As soon as you see the solid light on the Max calibration has been stored.

If the setup was successful, the status indicator remains on. The modulating gas valve is now operating normally.

The Calibration procedure does not need to be repeated for future startups. Only repeat the procedure if you believe the minimum or maximum pressure was set incorrectly.

Operation

Startup (Warm Up Procedure)

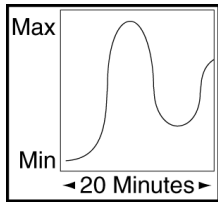

The modulating gas valve needs to go through a warm up procedure each time power is applied. The control unit warms up the pressure control valve by driving it full open. This warm up period may take up to 20 minutes, especially if the control unit has been off for several minutes or the building is cold. The status indicator remains on after the warm up period is complete.

Toggle Switch Settings

The toggle switch should always be at AUTO for normal operation.

The FULL ON position moves the pressure control valve to the full open position.

If the toggle switch is at FULL ON and then moved to AUTO, the warm up procedure described above is performed.

If the toggle switch is moved to OFF, or if power is removed from the control unit, the pressure control valve closes.

Response Time Settings

The control unit responds to the attached thermostat (or other temperature control device) by gradually increasing or decreasing gas pressure. The time it takes for this response to occur can be changed by moving DIP switches 1 and 2. A short delay time allows for a rapid response to temperature changes, but may also result in more temperature fluctuations.

DIP Switch Block Location
Control Unit Circuit Board

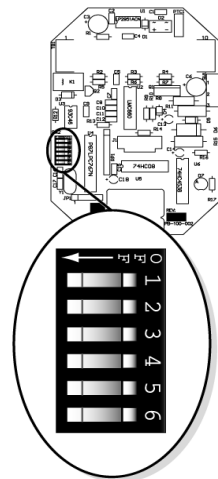

Response Time	Switch 1	Switch 2
4 Minutes	OFF	OFF
6 Minutes	ON	OFF
8 Minutes	OFF	ON
12 Minutes	ON	ON

Reset to Factory Default

Follow the steps shown below to reset the minimum and maximum gas pressure limits to the factory defaults.

1. Set the toggle switch to OFF.
2. Move DIP switches 3 and 4 to ON.
3. Move the toggle switch to ON and wait for the status indicator to be on steady.
4. Move the toggle switch to OFF.
5. Move DIP switches 3 and 4 to OFF.



The Set Minimum Pressure Limit and Set Maximum Pressure Limit procedures must be repeated anytime the control unit is reset to its factory defaults.

Status Indicator

A status indicator is located below the toggle switch on the side of the control unit. The indicator remains on during normal operation. The indicator will flash one through four times, pause, and then flash again if a problem occurs.

Status Indicator	Cause
Steady On	Normal operation.
One Flash	The gas pressure is beyond the minimum/maximum operating gas pressure. Reset the control unit to factory defaults and then repeat the Calibration procedure.
Two Flashes	The minimum and maximum gas pressures are still set to the factory defaults or the established pressure span does not meet the minimum span requirement. Perform the Calibration procedure.
Three Flashes	The current to the pressure control valve is outside the normal limits. Check the connections to the pressure control valve.
Four Flashes	There is a problem associated with the gas pressure sensor or circuit board.
Fast, Continuous Flash	The control unit is in the warm-up cycle.

Troubleshooting

Modulating gas valve seems to take a long time to heat up the building.

The first time the modulating gas valve is used, or when power is restored after a long interruption, it may take up to 20 minutes to complete the warm-up period. This varies depending on how cold the building and the pressure control valve are.

The status light is OFF.

Verify that 24VAC is being supplied to the control unit. Verify DIP switches 3 and 4 are in the OFF position unless you are performing the Calibration procedure.

The status indicator is flashing.

Refer to the Status Indicator table on the previous page.

Modulating gas valve won't increase gas pressure.

During the Calibration procedure, it may take up to 20 minutes before the pressure control valve opens enough to increase gas pressure. It is a highly sensitive valve and the control unit must change it very gradually. The pressure control valve may also require several minutes to open on subsequent start ups.

Specifications

Power Input	24VAC, 50/60 Hz, 0.5 Amps maximum
Output Pressure Ranges	Model MG 1: 11" WC Model MG 5: 2" WC to 5 psi Model MG 20: 8" WC to 20 psi
Capacity	Model MG 1: Pending Model MG 5: 204,000 BTU / Hr. Model MG 20: Pending
Input Options	1. Thermostat 2. Environmental control system device output 3. Variable control voltage - 0 to 10VDC
Igniter Relay Contacts:	Rated at 24VDC at 1 Amp
Control Unit Enclosure:	Dimensions: 4.25" x 3.00" x 1.375" Material: ABS plastic Rating: Type 2, Flame UL 94-V0

Service

Before calling for assistance, make sure you have checked the DIP switch settings and have reviewed the appropriate sections of this manual, especially the Troubleshooting section.

If you still need assistance, contact:

Raydot, LLC
145 Jackson Avenue
Cokato, MN 55321

Phone:
1-800-328-3813
1-320-286-2103

Fax:
1-320-286-2104