

# CPS-2M

## USER'S MANUAL

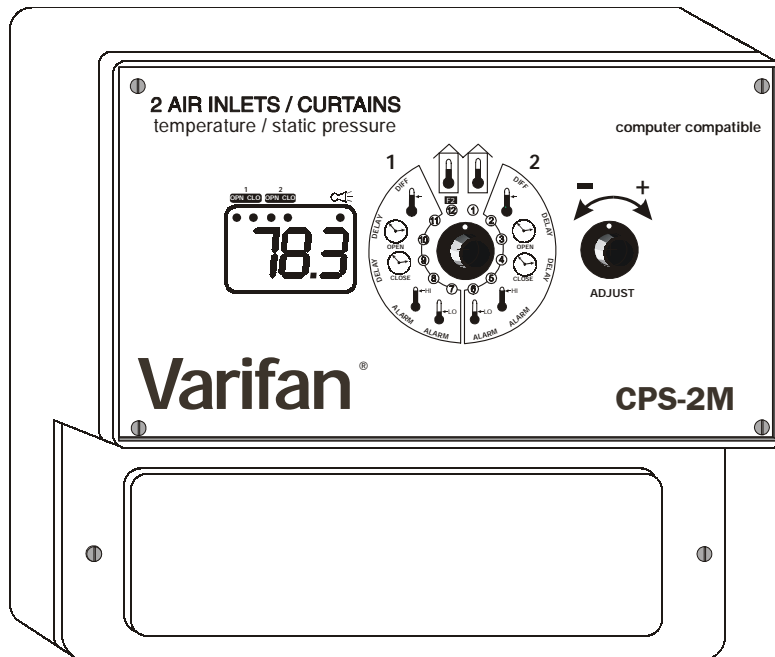

Although the manufacturer has made every effort to ensure the accuracy of the information contained herein, this document is subject to change without notice due to ongoing product development.

### **WARNINGS AND PRECAUTIONS**

Equipment , probe failure, blown fuses and/or tripped breakers may prove harmful to the contents of the building. Therefore it is strongly recommended to install backup devices and alarm or warning devices. Spare equipment should also be available at the owner's site. Equipment manufactured by the manufacturer is protected against normal line surges. High surges caused by thunder storms or power supply equipment may damage this equipment. For added security against line voltage surges it is recommended that surge and noise suppression devices be installed at the electrical distribution panel. Use of shielded cable for probes is recommended for protection against lightning. These devices are available from most electrical supply distributors.

### **RECOMMENDATIONS**

The manufacturer recommends that all installation procedures described herein be performed by a qualified electrician or installation technician. Further more the manufacturer recommends to test all the functions and equipment connected to the CPS, including the alarm system and backup devices, after installation, after change to the installation and once a month after that.

Fuse verification and replacement, as well as the proper setting of control values shall be the responsibility of the owner of this equipment.

*TABLE OF CONTENTS*

---

---

**CHAPTER 1 - INTRODUCTION**

1.	General .....	5
1.1	Description .....	5
	Definition of terms .....	6

**CHAPTER 2 - INSTALLATION**

2.1	Unpacking .....	7
2.2	Mounting .....	7
2.3	Switch Settings.....	8
2.3.1	Line Voltage Selector Switch .....	8
2.3.2	Software Settings DIP Switch .....	8
2.4	Connection Procedure .....	9
2.4.1	Input Power.....	9
2.4.1.1	115 VAC.....	9
2.4.1.2	230 VAC.....	9
2.4.2	Stage 1 Actuator Motor .....	9
2.4.3	Stage 2 Actuator Motor .....	9
2.5	Temperature / Static pressure Sensor .....	10
2.5.1	Single Temperature Probe .....	10
2.5.2	Temperature Averaging .....	10
2.5.3	Static Pressure Sensor .....	10
2.6	Alarm.....	11
2.7	Powering Up.....	11

**CHAPTER 3 - USER GUIDE**

LED Status Window .....	15
Control Dials.....	15

**PRIMARY FUNCTIONS**

Stage 2 ambient temperature / pressure display .....	17
Stage 2 main set point temperature / pressure .....	18
Stage 2 open run timer.....	19
Stage 2 close run timer .....	20
Stage 2 record high temperature / pressure .....	21
Stage 2 record low temperature / pressure.....	22
Stage 1 record low temperature / pressure.....	23
Stage 1 record high temperature / pressure .....	24
Stage 1 close run timer .....	25
Stage 1 open run timer.....	26
Stage 1 main set point temperature / pressure .....	27
Stage 1 ambient temperature / pressure display .....	28

## **SECONDARY FUNCTIONS**

Stage 2 differential .....	29
Stage 2 open delay timer .....	30
Stage 2 close delay timer .....	31
Stage 2 high temperature / pressure alarm.....	32
Stage 2 low temperature / pressure alarm.....	33
Stage 1 low temperature / pressure alarm .....	34
Stage 1 high temperature / pressure alarm.....	35
Stage 1 close delay timer .....	36
Stage 1 open delay timer .....	37
Stage 1 differential .....	38

## **APPENDIX**

Troubleshooting .....	40
Specifications .....	41
Record Form .....	42

## **1. GENERAL**

This document provides a description of the CPS-2M control panel. This document is organized as follows:

- Introduction
- Installation
- User's Guide
- Appendix

Congratulations on the purchase of your CPS-2M environmental control system. The CPS-2M provides you with full control over static pressure and air flow resulting in a comfortable environment for your livestock.

The CPS-2M provides microprocessor control over two independent stages.

Each stage regulates the static pressure of a separate room via the use of actuator motors which in turn control the building's air inlet baffle boards or air inlet curtains. The CPS-2M can either use temperature (with temperature probe 2004-1k) or for greater accuracy static pressure (with static pressure probe model # SPS-1) as a means to control the opening of air inlet baffle/curtains.

The CPS-2M provides you with full control over its two stages via the use of an easy to follow display panel. All programmable features can be customized to meet your requirements.

Each stage has programmable temperature and static pressure set points which are the base point for the control of actuator motors. The delay time before actuator motors start to run, as well as the period of time they operate are fully programmable.

## **DEFINITION OF TERMS**

### **MAIN SET POINT**

The desired room temperature or pressure.

### **ROOM TEMPERATURE / PRESSURE**

The actual temperature / pressure of the room.  
(also called ambient temperature in the text)

### **AIR INLET BAFFLE BOARD/AIR INLET CURTAIN**

A device which regulates air flow into a building by controlling the opening or closing of an air passage.

**The manufacturer recommends that the installation instructions which follow be adhered to as closely as possible, and all work be performed by a certified electrician. Failure to do so may void the warranty!**

## **2.1 UNPACKING**

Unpack the CPS-2M from its box and inspect contents for damage. Should the contents appear to be damaged, contact your local distributor for return material procedures.

The package should contain the following standard items:

- 1 CPS-2M control panel identified by CPS-2M
- 3 cable fasteners
- 2 temperature probes

The following optional items may be included:

- 3 additional temperature probes per zone for temperature averaging
- 2 SPS-1 static pressure sensor.

**To limit the unit's exposure to noxious gases install the unit in a hallway.**

**Make certain that the unit is mounted right side up with the cable entry holes facing down.**

**The CPS-2M will operate in a temperature range of 42°F - 111 °F (5.5 °C - 44 °C).**

**The enclosure is watertight, it is not splash proof or immersion proof. DO NOT WATER the control. Cover carefully with plastic when you are clean the room.**

**It is prohibited to use overhead cables outside the building.**

## **2.2 MOUNTING**

Mount the CPS-2M to the wall using the mounting holes located on the flange of the control housing.

**Mounting hardware is not shipped with the unit.**

## CPS-2M

---

---

Once the CPS-2M is in place, use a screwdriver to remove the six screws holding the faceplate to the housing.

### **2.3 SWITCH SETTING**

The CPS-2M is configured for a variety of options via two switches: the line voltage selector switch, and the software settings DIP switch. These switches are described in the following two sections.

#### **2.3.1 - Line Voltage Selector Switch**



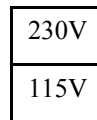

This switch is located on the surface of the main (bottom) board and adapts the CPS-2M for 115 VAC or 230 VAC line voltage. The manufacturer set the switch to 230 VAC. If you wish to use it on 115 VAC you have to select to 115 VAC before turning on the power



Refer to figures 1 through 2.

#### **2.3.2 - Software Settings DIP Switch**

This switch is located at the rear of the CPS-2M faceplate and adjusts the following options.

		OFF	ON
OFF	ON		
	1	Fahrenheit	Celsius
	2	Settings locked	Setting unlocked
	3	High static pressure sensitivity	Normal static pressure sensitivity
	4	Temperature mode	Pressure mode

- Switch 1** Fahrenheit or Celsius display on the CPS-2M
- Switch 2** Locks or unlocks your settings. All settings except for main set point, record low, and record high are locked while this switch is off.
- Switch 3** Increases static pressure sensitivity with DIP switch set to OFF. (The static pressure reading will react faster with High sensitivity).
- Switch 4** Static pressure mode or temperature mode.



## **2.4 CONNECTION PROCEDURE**

### **2.4.1 - Input power**

Use a screwdriver to remove cable knock-outs for the installation of cabling to the control panel.

**Do not apply power to the CPS-2M until all connections have been completed!**

#### **2.4.1.1 - 115 VAC**

**Make certain that the line voltage selector switch is set to 115 VAC.** Connect the live of the power cable to terminal 12 and neutral of the power cable to terminal 11 on the main (bottom) board.

#### **2.4.1.2 - 230 VAC**

**Make certain that the line voltage selector switch is set to 230 VAC.** Connect L1 of the power cable to terminal 12 and L2 of the power cable to terminal 11 on the main (bottom) board.

### **2.4.2 - Stage one actuator motor**

Stage 1 provides two dry contacts which control a linear actuator motor used to operate an air inlet baffle board or air inlet curtain. One dry contact is used to operate the motor winding which reduces the air opening, and one dry contact is used to operate the motor winding which increases the air opening. The current rating of these dry contacts are 6 Amps (inductive). Refer to figure 1 and 2.

### **2.4.3 - Stage two actuator motor**

Stage 2 provides two dry contacts which control a linear actuator motor used to operate an air inlet baffle board or air inlet curtain. One dry contact closure is used to operate the motor winding which reduces the air opening, and one dry contact closure is used to operate the motor winding which increases the air opening. The current rating of these dry contacts are 6 Amps (inductive). Refer to figure 1 and

To connect a 2-wire DC actuator, see figure 0

To connect **two actuators on the same output**, see figure 1a.

To connect a three phase motor, see figure 6.

## **2.5 TEMPERATURE PROBES / STATIC PRESSURE SENSORS**

Temperature probe and static pressure sensor use a “Class 2” low voltage circuit. Their cable can be extended up to 500 feet (150 meters).

Single probe temperature and static pressure connections are illustrated in Figure 3 while temperature probe averaging connections are illustrated in Figure 4.

**Use shielded cabling for probes . Connect the shields to terminal “shld”. Failure to do so may result in inaccurate readings!**

### **2.5.1 2 Single Temperature Probe**

Install a single temperature probe in an area that best reflects the overall temperature of the room.

Connect the two leads of the temperature probe to the CPS-2 terminals labelled IN1(IN2 for probe 2), GNA and SHLD as indicated in Figure 3.

### **2.5.2 Temperature Averaging**

Four temperature probes are required if temperature averaging is desired in larger rooms. Place the probes in locations that best reflect the ambient temperature. Refer to Figure 4.

### **2.5.3 2 Static Pressure Sensor**

To properly position a SPS-1 static pressure sensor inside the building refer to the installation manual supplied with the unit.  
**Important: disconnect temperature probe, when the static pressure sensor is used.**

Connect the static pressure probe to the CPS-2M terminals labeled IN1 (IN2 for sensor 2), PWR, GNA and SHLD as indicated in Figure 3.

**Momentary power interruptions may trigger false alarms! To avoid false alarming when the CPS-2M is connected to an alarm system, install a time delay relay between the CPS-2M and the alarm system.**

## 2.6 ALARM

The CPS-2M provides a normally open and normally closed dry contact for alarming low or high temperature conditions. In addition, this same contact can be used to signal a power failure. This contact may be connected to an alarm system, or directly to a siren and/or auto-dialer. Make connections as indicated in Figure 3.

## 2.7 POWERING UP

Before powering up the CPS-2M, attach the faceplate to the casing of the CPS-2M using the four screws previously removed.

- Set Selector knob to position (12).
- Upon power up, the unit will test its display by briefly lighting all the segments of its LED. Make certain that all segments light.
- Following the LED display test, the unit displays the ambient temperature or pressure of the room.
- If the temperature or pressure is not displayed, refer to the Trouble Shooting section in the appendix of this document.

Fig 0 Wiring diagram for a 2-wire DC actuator

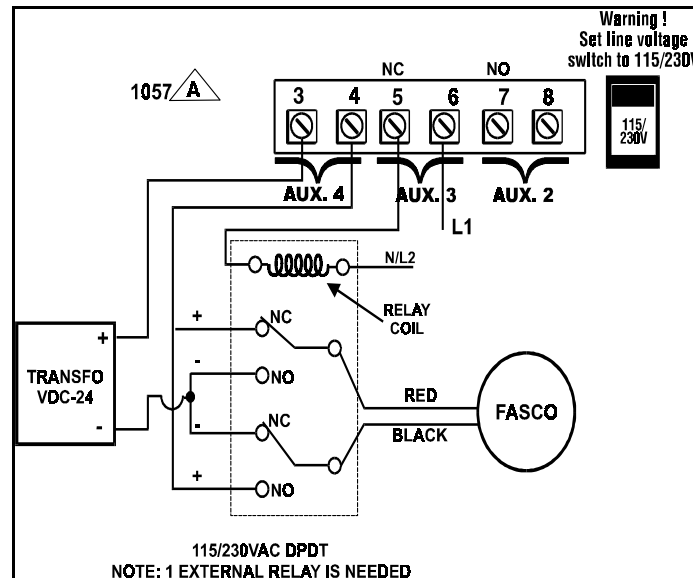

**CPS-2M**

Fig.1 Two Actuator Motors (230V)

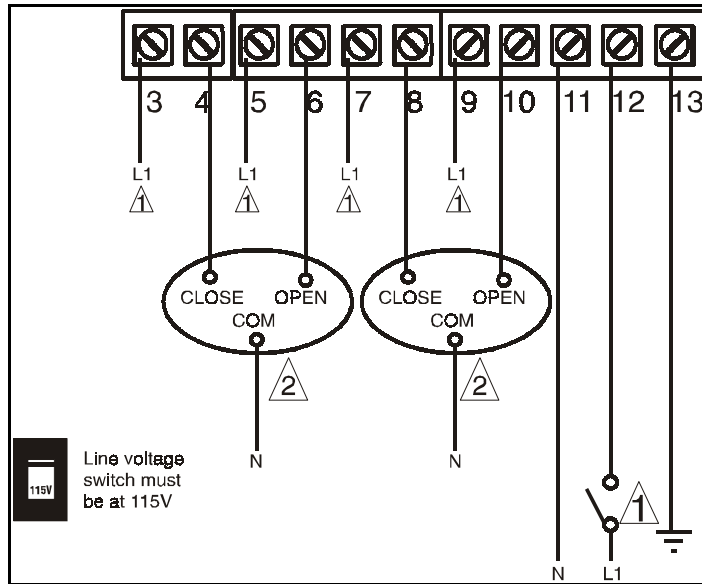

Fig 1a Two actuators connected on the same output

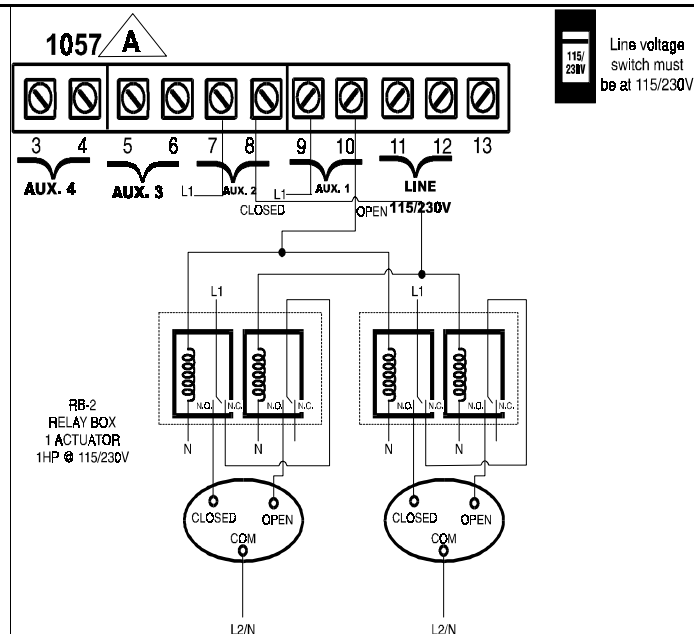

Fig 2  
Temperature Probe and Static Pressure Sensor

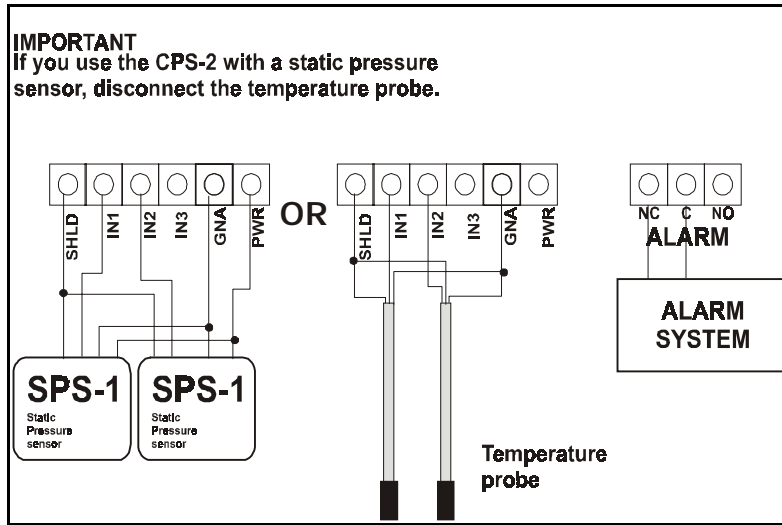
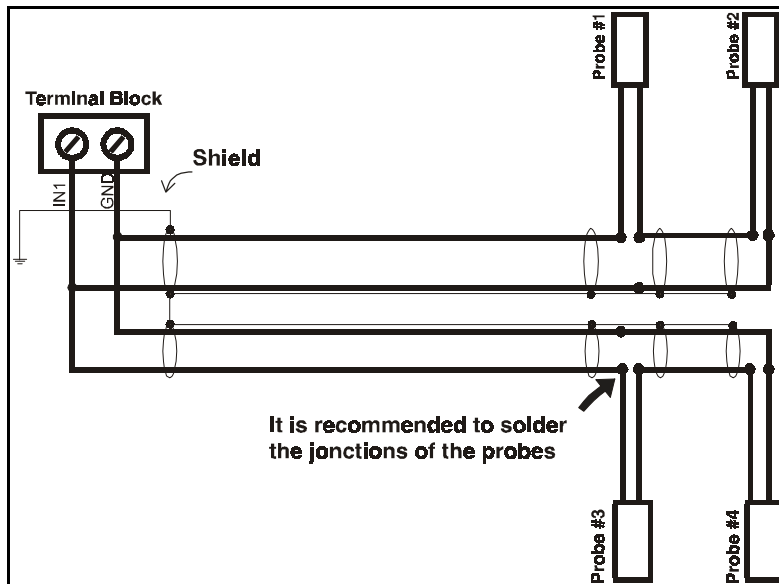

Fig 3  
Temperature Averaging Probe Connection



**CPS-2M**

Fig 5  
Main Board: Terminal Blocks, Switch, and Jumpers

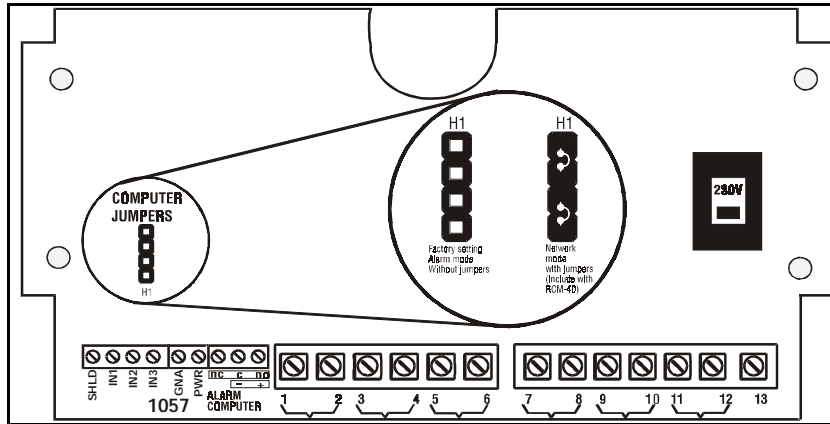
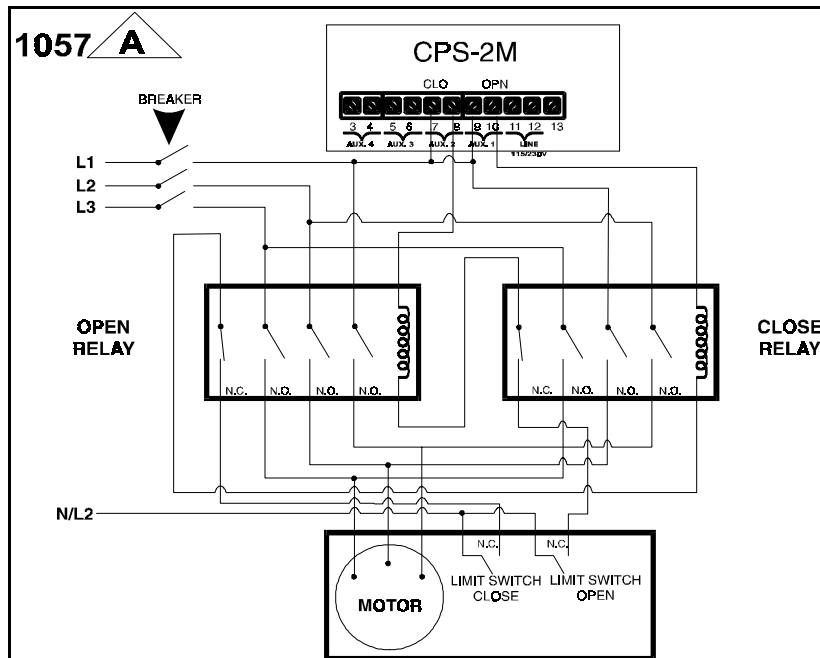

Figure 6  
Wiring diagram for a three phase motor



**2 AIR INLETS / CURTAINS**

temperature / static pressure

computer compatible

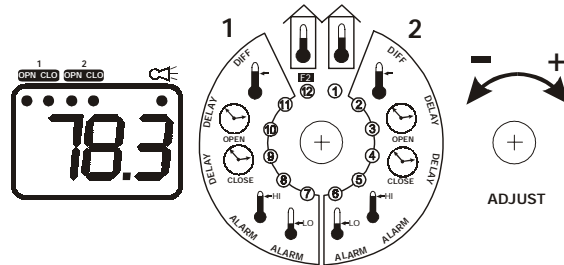

**Varifan**<sup>®</sup>

**CPS-2M**

The CPS-2M front panel shown above features a LED status window and two control dials which are respectively used to select a function and adjust a setting.

**LED Status Window**

The LED status window features a 3 digit LED readout for the display of temperature in Fahrenheit or Celsius, pressure level, and programmable settings.

In addition, the LED status window displays the operational status of stage 2 via five additional LEDs (shown above in LED window) that indicate the opening or closing of the air inlet / baffle board. When illuminated, each LED indicates that the actuator motor is operating. A fifth LED is an alarm indicator.

**Control Dials**

The center dial is the Selector dial and is used to select one of the CPS-2M 12 primary or 10 secondary functions. The dial located to the right of the Selector dial is the Adjustor dial and is used to adjust the setting of each function or to enter secondary function mode.

**The 12 primary functions are:**

- 1 Stage 2 ambient temperature / pressure display
- 2 Stage 2 main set point temperature / pressure
- 3 Stage 2 open run timer
- 4 Stage 2 close run timer
- 5 Stage 2 record high temperature / pressure

## *CPS-2M*

---

---

- 6 Stage 2 record low temperature / pressure
- 7 Stage 1 record low temperature / pressure
- 8 Stage 1 record high temperature / pressure
- 9 Stage 1 close run timer
- 10 Stage 1 open run timer
- 11 Stage 1 main set point temperature / pressure
- 12 Stage 1 ambient temperature / pressure display

Any one of these primary functions is selected by rotating the Selector dial to the corresponding number and associated graphical image printed on the faceplate of the panel. When primary functions 2 through 11 are selected, the LED status window displays a blinking value. Function 12 and 1 displays ambient temperature or static pressure levels.

### **The 10 secondary functions are:**

- 2 Stage 2 differential
- 3 Stage 2 open delay timer
- 4 Stage 2 close delay timer
- 5 Stage 2 High temperature / pressure alarm
- 6 Stage 2 Low temperature / pressure alarm
- 7 Stage 1 Low temperature / pressure alarm
- 8 Stage 1 High temperature / pressure alarm
- 9 Stage 1 close delay timer
- 10 Stage 1 open delay timer
- 11 Stage 1 differential

Select any one of these secondary functions by:

- rotating the Selector dial to (12)
- rapidly rotating the Adjustor dial back and forth to enter secondary mode.
- rotating the Selector dial from function (12) to any other secondary function.

When secondary functions 2 through 11 are selected, the status window displays a blinking value along with a scrolling LED display. Selection of function 12 removes the CPS-2M from the secondary function mode.



## STAGE 2 TEMPERATURE PRESSURE DISPLAY

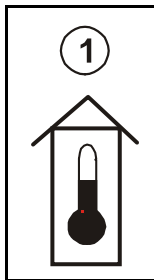

This function displays the room temperature or static pressure of the room (stage 2).

If a temperature probe is installed, the room temperature is displayed to the nearest 0.5 degree from a minimum display of 42.0°F (5.5° C) to a maximum display of 111°F (44.0°C). If the temperature is lower than 42.0°F, **Lo** is displayed. If the temperature is higher than 111°F, **Hi** is displayed.

If a static pressure probe is installed, the static pressure is displayed to the nearest 0.01" H<sub>2</sub>O from a minimum display of -0.20" H<sub>2</sub>O to a maximum display of 0.20" H<sub>2</sub>O. If the pressure is lower than -0.20" H<sub>2</sub>O, **Lo** is displayed. If the temperature is higher than 0.20" H<sub>2</sub>O, **Hi** is displayed.

### Viewing the ambient temperature / pressure:

- rotate the Selector dial to position (1)

The ambient temperature / pressure is displayed on the CPS-2M.

## **STAGE 2 MAIN SET POINT TEMPERATURE / PRESSURE**

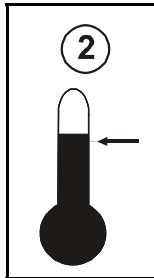

When a temperature probe is installed, the main set point establishes the target temperature in the building. The main set point temperature is adjusted in 0.5 degree increments from a minimum setting of 42.0°F (5.5°C) to a maximum setting of 111°F (44.0°C).

When a static pressure probe is installed, the main set point establishes the target pressure level in the building. The main set point pressure level is adjusted in 0.01" H<sub>2</sub>O increments from a minimum setting of OPN, 0.0" H<sub>2</sub>O to a maximum setting of 0.14" H<sub>2</sub>O, and CLO.

### **Adjusting the main set point temperature / pressure level:**

- rotate the Selector dial to position (2),
- rotate the Adjustor dial counterclockwise to decrease the setting, and clockwise to increase it.

The main set point temperature / pressure level is displayed on the CPS-2M.

**Note:**

The actuator motor may be manually controlled by adjusting the main set point to OPN or CLO thereby causing the air inlet to either remain fully open or closed.

## STAGE 2 OPEN RUN TIMER

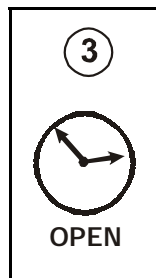

The open run timer establishes the period of time that the actuator motor operates when it receives the command to open an air inlet baffle board or air inlet curtain.

The open run timer is adjusted in 1 second increments from a minimum setting of 1 second to a maximum setting of 1 minute 59 seconds.

### Adjusting the open run timer:

- rotate the Selector dial to position (3),
- rotate the Adjustor dial counterclockwise to decrease the setting, and clockwise to increase it.

The open run timer setting is displayed on the CPS-2M.

### Example:

The open run timer is set to 30 seconds. When the control determines that the air inlet must open, the command to the motor is sent after the delay set by secondary function (2) has expired. The actuator motor will operate for 30 seconds before stopping.

## STAGE 2 CLOSE RUN TIMER

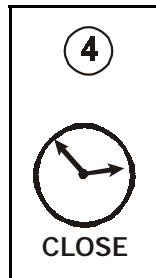

The close run timer establishes the period of time that the actuator motor operates when it receives the command to close an air inlet baffle board or air inlet curtain.

The close run timer is adjusted in 1 second increments from a minimum setting of 1 second to a maximum setting of 1 minute 59 seconds.

### **Adjusting the close run timer:**

- rotate the Selector dial to position (4),
- rotate the Adjustor dial counterclockwise to decrease the setting, and clockwise to increase it.

The close run timer setting is displayed on the CPS-2M.

### **Example:**

The close run timer is set to 30 seconds. When the control determines that the air inlet must close, the command to the motor is sent after the delay set by secondary function (3) has expired. The actuator motor will operate for 30 seconds before stopping.

## STAGE 2 RECORD HIGH TEMPERATURE / PRESSURE

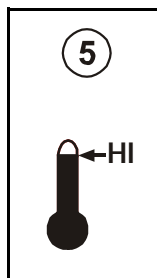

This function displays the highest recorded temperature / pressure since the last clear.

When a temperature probe is installed, the record high temperature is rounded to the nearest 0.5 degree from a minimum display of 42.0°F (5.5°C) to a maximum display of 111°F (44.0°C). If a temperature higher than 111°F is recorded, **Hi** is displayed.

When a pressure probe is installed, the record high pressure is displayed in 0.01" H<sub>2</sub>O increments from a minimum display of -0.20" H<sub>2</sub>O to a maximum display of 0.20" H<sub>2</sub>O. If a pressure level higher than 0.20" H<sub>2</sub>O is recorded, **Hi** is displayed.

### Displaying the highest temperature / pressure recorded:

- rotate the Selector dial to position (5)

### Clearing the high temperature / pressure value

- quickly rotate the Adjustor dial counterclockwise, then clockwise.

**CLr** will be briefly displayed on the CPS-2M.

## STAGE 2 RECORD LOW TEMPERATURE/PRESSURE

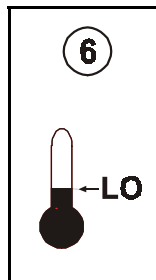

This function displays the lowest recorded temperature / pressure since the last clear.

When a temperature probe is installed, the record low temperature is rounded to the nearest 0.5 degree from a minimum display of 42.0°F (5.5°C) to a maximum display of 111°F (44.0°C). If a temperature lower than 42.0°F is recorded, **Lo** is displayed.

When a pressure probe is installed, the record low pressure is displayed in 0.01" H<sub>2</sub>O increments from a minimum display of -0.20" H<sub>2</sub>O to a maximum display of 0.20" H<sub>2</sub>O. If a pressure level lower than - 0.20" H<sub>2</sub>O is recorded, **Lo** is displayed.

### **Viewing the lowest temperature / pressure recorded:**

- rotate the Selector dial to position (6)

### **Clearing the low temperature / pressure value:**

- quickly rotate the Adjustor dial counterclockwise, then clockwise.

CLr will be briefly displayed on the CPS-2M.

## STAGE 1 RECORD LOW TEMPERATURE/PRESSURE

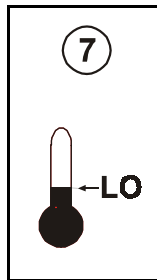

This function displays the lowest recorded temperature / pressure since the last clear.

When a temperature probe is installed, the record low temperature is rounded to the nearest 0.5 degree from a minimum display of 42.0°F (5.5°C) to a maximum display of 111°F (44.0°C). If a temperature lower than 42.0°F is recorded, **Lo** is displayed.

When a pressure probe is installed, the record low pressure is displayed in 0.01" H<sub>2</sub>O increments from a minimum display of -0.20" H<sub>2</sub>O to a maximum display of 0.20" H<sub>2</sub>O. If a pressure level lower than - 0.20" H<sub>2</sub>O is recorded, **Lo** is displayed.

### **Viewing the lowest temperature / pressure recorded:**

- rotate the Selector dial to position (7)

### **Clearing the low temperature / pressure value:**

- quickly rotate the Adjustor dial counterclockwise, then clockwise.

CLr will be briefly displayed on the CPS-2M.

## STAGE 1 RECORD HIGH TEMPERATURE / PRESSURE

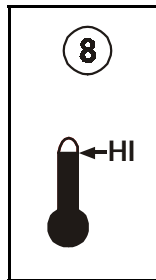

This function displays the highest recorded temperature / pressure since the last clear.

When a temperature probe is installed, the record high temperature is rounded to the nearest 0.5 degree from a minimum display of 42.0°F (5.5°C) to a maximum display of 111°F (44.0°C). If a temperature higher than 111°F is recorded, **Hi** is displayed.

When a pressure probe is installed, the record high pressure is displayed in 0.01" H<sub>2</sub>O increments from a minimum display of -0.20" H<sub>2</sub>O to a maximum display of 0.20" H<sub>2</sub>O. If a pressure level higher than 0.20" H<sub>2</sub>O is recorded, **Hi** is displayed.

### **Displaying the highest temperature / pressure recorded:**

- rotate the Selector dial to position (8)

### **Clearing the high temperature / pressure value**

- quickly rotate the Adjustor dial counterclockwise, then clockwise.

**CLr** will be briefly displayed on the CPS-2M.



## STAGE 1 CLOSE RUN TIMER

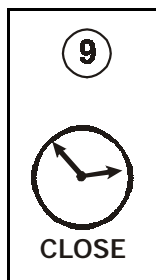

The close run timer establishes the period of time that the actuator motor operates when it receives the command to close an air inlet baffle board or air inlet curtain.

The close run timer is adjusted in 1 second increments from a minimum setting of 1 second to a maximum setting of 1 minute 59 seconds.

### Adjusting the close run timer:

- rotate the Selector dial to position (9),
- rotate the Adjustor dial counterclockwise to decrease the setting, and clockwise to increase it.

The close run timer setting is displayed on the CPS-2M.

### Example:

The close run timer is set to 30 seconds. When the control determines that the air inlet must close, the command to the motor is sent after the delay set by secondary function (3) has expired. The actuator motor will operate for 30 seconds before stopping.

## STAGE 1 OPEN RUN TIMER

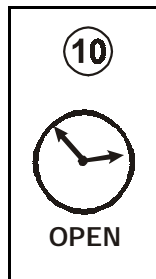

The open run timer establishes the period of time that the actuator motor operates when it receives the command to open an air inlet baffle board or air inlet curtain.

The open run timer is adjusted in 1 second increments from a minimum setting of 1 second to a maximum setting of 1 minute 59 seconds.

### **Adjusting the open run timer:**

- rotate the Selector dial to position (10),
- rotate the Adjustor dial counterclockwise to decrease the setting, and clockwise to increase it.

The open run timer setting is displayed on the CPS-2M.

### **Example:**

The open run timer is set to 30 seconds. When the control determines that the air inlet must open, the command to the motor is sent after the delay set by secondary function (2) has expired. The actuator motor will operate for 30 seconds before stopping.

## STAGE 1 MAIN SET POINT TEMPERATURE / PRESSURE

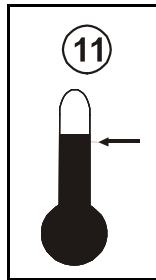

When a temperature probe is installed, the main set point establishes the target temperature in the building. The main set point temperature is adjusted in 0.5 degree increments from a minimum setting of 42.0°F (5.5°C) to a maximum setting of 111°F (44.0°C).

When a static pressure probe is installed, the main set point establishes the target pressure level in the building. The main set point pressure level is adjusted in 0.01" H<sub>2</sub>O increments from a minimum setting of OPN, 0.0" H<sub>2</sub>O to a maximum setting of 0.14" H<sub>2</sub>O, and CLO.

### **Adjusting the main set point temperature / pressure level:**

- rotate the Selector dial to position (11),
- rotate the Adjustor dial counterclockwise to decrease the setting, and clockwise to increase it.

The main set point temperature / pressure level is displayed on the CPS-2M.

### **Note:**

The actuator motor may be manually controlled by adjusting the main set point to OPN or CLO thereby causing the air inlet to either remain fully open or closed.

## STAGE 1 TEMPERATURE PRESSURE DISPLAY

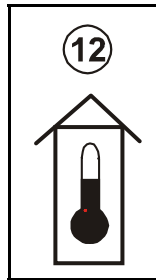

This function displays the ambient room temperature or static pressure of the room.

If a temperature probe is installed, the ambient temperature is displayed to the nearest 0.5 degree from a minimum display of 42.0°F (5.5° C) to a maximum display of 111°F (44.0°C). If the temperature is lower than 42.0°F, **Lo** is displayed. If the temperature is higher than 111°F, **Hi** is displayed.

If a static pressure probe is installed, the static pressure is displayed to the nearest 0.01" H<sub>2</sub>O from a minimum display of -0.20" H<sub>2</sub>O to a maximum display of 0.20" H<sub>2</sub>O. If the pressure is lower than -0.20" H<sub>2</sub>O, **Lo** is displayed. If the temperature is higher than 0.20" H<sub>2</sub>O, **Hi** is displayed.

### **Viewing the ambient temperature / pressure:**

- rotate the Selector dial to position (12)

The ambient temperature / pressure is displayed on the CPS-2M.

## STAGE 2 ACTUATOR MOTOR DIFFERENTIAL

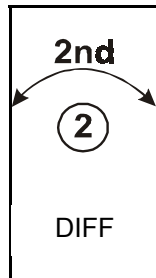

In order to minimize erratic behavior of the actuator motor when the ambient room temperature or static pressure is exactly at the main set point, the differential setting separates this ON / OFF threshold into two: one ON threshold and one OFF. This feature greatly reduces equipment wear.

The temperature / pressure difference between the two thresholds is the differential.

When a temperature probe is installed, the differential is adjusted in 0.5 degree increments from a minimum setting of 0.0°F (0.0°C) to a maximum setting of 16°F (8°C) degrees.

When a pressure probe is installed, the differential is adjusted in 0.01"H<sub>2</sub>O increments from a minimum setting of 0.00"H<sub>2</sub>O to a maximum setting of 0.05"H<sub>2</sub>O.

### Adjusting the differential setting:

- rotate the Selector dial to position (12),
- rapidly rotate the Adjustor dial back and forth to enter secondary function mode,
- rotate the Selector dial to position (2),
- rotate the Adjustor dial counterclockwise to decrease the setting, and clockwise to increase it.

The differential setting is displayed on the CPS-2M.

## STAGE 2 OPEN DELAY TIMER

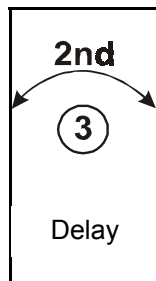

The open delay timer establishes the delay interval between the time the control determines that an actuator motor should open, and the time that the signal is actually sent.

The open delay timer is adjusted in 5 second increments from a minimum setting of 5 seconds, to a maximum setting of 9 minutes 55 seconds.

### **Adjusting the open delay timer:**

- rotate the Selector dial to position (12),
- rapidly rotate the Adjustor dial back and forth to enter secondary function mode,
- rotate the Selector dial to position (3),
- rotate the Adjustor dial counterclockwise to decrease the delay, and clockwise to increase it.

The delay timer is displayed on the CPS-2M.

### **Example:**

The open delay timer is set to 1 minute. The actuator motor, when called upon to open the air inlet, will operate after 1 minute has passed.

## STAGE 2 CLOSE DELAY TIMER

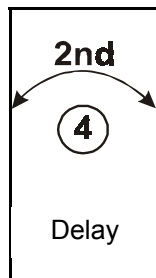

The close delay timer establishes the delay interval between the time the control determines that an actuator motor should close, and the time that the signal is actually sent.

The close delay timer is adjusted in 5 second increments from a minimum setting of 5 seconds, to a maximum setting of 9 minutes 55 seconds.

### Adjusting the close delay timer:

- rotate the Selector dial to position (12),
- rapidly rotate the Adjustor dial back and forth to enter secondary function mode,
- rotate the Selector dial to position (4),
- rotate the Adjustor dial counterclockwise to decrease the delay, and clockwise to increase it.

The delay timer is displayed on the CPS-2M.

### Example:

The close delay timer is set to 1 minute. The actuator motor, when called upon to close the air inlet, will operate after 1 minute has passed.

## STAGE 2 HIGH TEMPERATURE / PRESSURE ALARM

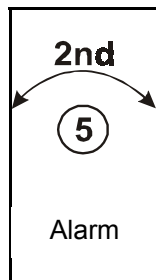

This function establishes the temperature / pressure **difference** above the main set point that the room can reach before a high temperature / pressure alarm is signalled. When a high temperature / pressure alarm occurs the alarm relay is activated and the alarm LED lights on the CPS-2M.

When a temperature probe is installed the high temperature / pressure alarm is adjusted in 0.5 degree increments from a minimum setting of 0.0°F (0.0°C) to a maximum setting of 30.0°F (18.0°C).

When a pressure probe is installed the high pressure alarm is adjusted in 0.01" H<sub>2</sub>O increments from a minimum setting of 0.0 " H<sub>2</sub>O to a maximum setting of 0.10 " H<sub>2</sub>O.

### **Adjusting the high temperature / pressure alarm setting:**

- rotate the Selector dial to position (12),
- rapidly rotate the Adjustor dial back and forth to enter secondary function mode,
- rotate the Selector dial to position (5),
- rotate the Adjustor dial counterclockwise to decrease the setting, and clockwise to increase it.

The high temperature alarm setting is displayed on the CPS-2M.



## STAGE 2 LOW TEMPERATURE / PRESSURE ALARM

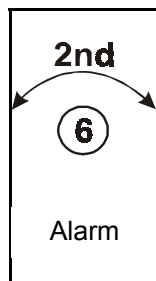

This function establishes the temperature / pressure **difference** below the main set point that the room can reach before a low temperature alarm is signalled. When a low temperature / pressure alarm occurs the alarm relay is activated and the alarm LED lights on the CPS-2M.

When a temperature probe is installed the low temperature alarm is adjusted in 0.5 degree increments from a minimum setting of -30.0°F (-18.0°C) to a maximum setting of 0.0°F (0.0°C)

When a pressure probe is installed the low pressure alarm is adjusted in 0.01" H<sub>2</sub>O increments from a minimum setting of -0.10" H<sub>2</sub>O to a maximum setting of 0.00 " H<sub>2</sub>O.

### **Adjusting the low temperature / pressure alarm setting:**

- rotate the Selector dial to position (12),
- rapidly rotate the Adjustor dial back and forth to enter secondary function mode,
- rotate the Selector dial to position (6),
- rotate the Adjustor dial counterclockwise to decrease the setting, and clockwise to increase it.

The low temperature alarm setting is displayed on the CPS-2M.

## STAGE 1 LOW TEMPERATURE / PRESSURE ALARM

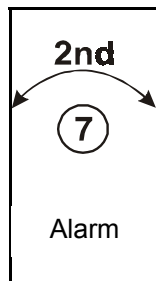

This function establishes the temperature / pressure **difference** below the main set point that the room can reach before a low temperature alarm is signalled. When a low temperature / pressure alarm occurs the alarm relay is activated and the alarm LED lights on the CPS-2M.

When a temperature probe is installed the low temperature alarm is adjusted in 0.5 degree increments from a minimum setting of -30.0°F (-18.0°C) to a maximum setting of 0.0°F (0.0°C)

When a pressure probe is installed the low pressure alarm is adjusted in 0.01" H<sub>2</sub>O increments from a minimum setting of -0.10" H<sub>2</sub>O to a maximum setting of 0.00 " H<sub>2</sub>O.

### **Adjusting the low temperature / pressure alarm setting:**

- rotate the Selector dial to position (12),
- rapidly rotate the Adjustor dial back and forth to enter secondary function mode,
- rotate the Selector dial to position (7),
- rotate the Adjustor dial counterclockwise to decrease the setting, and clockwise to increase it.

The low temperature alarm setting is displayed on the CPS-2M.

## STAGE 1 HIGH TEMPERATURE / PRESSURE ALARM

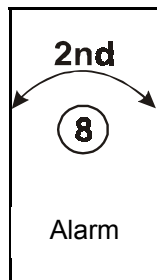

This function establishes the temperature / pressure **difference** above the main set point that the room can reach before a high temperature / pressure alarm is signalled. When a high temperature / pressure alarm occurs the alarm relay is activated and the alarm LED lights on the CPS-2M.

When a temperature probe is installed the high temperature / pressure alarm is adjusted in 0.5 degree increments from a minimum setting of 0.0°F (0.0°C) to a maximum setting of 30.0°F (18.0°C).

When a pressure probe is installed the high pressure alarm is adjusted in 0.01" H<sub>2</sub>O increments from a minimum setting of 0.0 " H<sub>2</sub>O to a maximum setting of 0.10 " H<sub>2</sub>O.

### **Adjusting the high temperature / pressure alarm setting:**

- rotate the Selector dial to position (12),
- rapidly rotate the Adjustor dial back and forth to enter secondary function mode,
- rotate the Selector dial to position (8),
- rotate the Adjustor dial counterclockwise to decrease the setting, and clockwise to increase it.

The high temperature alarm setting is displayed on the CPS-2M.

## STAGE 1 CLOSE DELAY TIMER

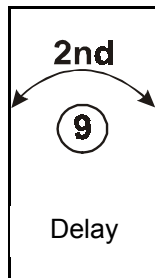

The close delay timer establishes the delay interval between the time the control determines that an actuator motor should close, and the time that the signal is actually sent.

The close delay timer is adjusted in 5 second increments from a minimum setting of 5 seconds, to a maximum setting of 9 minutes 55 seconds.

### **Adjusting the close delay timer:**

- rotate the Selector dial to position (12),
- rapidly rotate the Adjustor dial back and forth to enter secondary function mode,
- rotate the Selector dial to position (9),
- rotate the Adjustor dial counterclockwise to decrease the delay, and clockwise to increase it.

The delay timer is displayed on the CPS-2M.

### **Example:**

The close delay timer is set to 1 minute. The actuator motor, when called upon to close the air inlet, will operate after 1 minute has passed.

## STAGE 1 OPEN DELAY TIMER

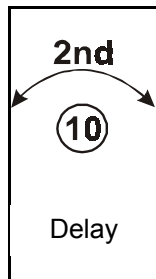

The open delay timer establishes the delay interval between the time the control determines that an actuator motor should open, and the time that the signal is actually sent.

The open delay timer is adjusted in 5 second increments from a minimum setting of 5 seconds, to a maximum setting of 9 minutes 55 seconds.

### Adjusting the open delay timer:

- rotate the Selector dial to position (12),
- rapidly rotate the Adjustor dial back and forth to enter secondary function mode,
- rotate the Selector dial to position (10),
- rotate the Adjustor dial counterclockwise to decrease the delay, and clockwise to increase it.

The delay timer is displayed on the CPS-2M.

### Example:

The open delay timer is set to 1 minute. The actuator motor, when called upon to open the air inlet, will operate after 1 minute has passed.

## STAGE 1 ACTUATOR MOTOR DIFFERENTIAL

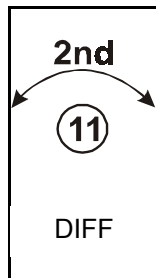

In order to minimize erratic behavior of the actuator motor when the room temperature or static pressure is exactly at the main set point, the differential setting separates this ON / OFF threshold into two: one ON threshold and one OFF. This feature greatly reduces equipment wear.

The temperature / pressure difference between the two thresholds is the differential.

When a temperature probe is installed, the differential is adjusted in 0.5 degree increments from a minimum setting of 0.0°F (0.0°C) to a maximum setting of 16°F (8°C) degrees.

When a pressure probe is installed, the differential is adjusted in 0.01"H<sub>2</sub>O increments from a minimum setting of 0.00"H<sub>2</sub>O to a maximum setting of 0.05"H<sub>2</sub>O.

### Adjusting the differential setting:

- rotate the Selector dial to position (12),
- rapidly rotate the Adjustor dial back and forth to enter secondary function mode,
- rotate the Selector dial to position (11),
- rotate the Adjustor dial counterclockwise to decrease the setting, and clockwise to increase it.

The differential setting is displayed on the CPS-2M.

**APPENDIX**

## TROUBLESHOOTING

<b>SYMPTOM</b>	<b>CAUSE and REMEDY</b>
<b>Lo is continually displayed</b>	<ul style="list-style-type: none"><li>- Temperature or pressure is below minimum.</li><li>- Probe is disconnected or defective.</li></ul>
<b>Hi is continually displayed</b>	<ul style="list-style-type: none"><li>- Temperature or pressure is above maximum.</li><li>- Probe is short circuited.</li></ul>
<b>Actuator motor is not operating</b>	<ul style="list-style-type: none"><li>- Verify whether the appropriate stage LED is on yet the actuator motor is not operating. Verify wiring and device</li></ul>
<b>Display is blank</b>	<ul style="list-style-type: none"><li>- Verify that the line voltage selector switch is properly set.</li><li>- Verify that the 10 pin flat cable between the main board and the faceplate board is properly connected.</li></ul>



---

---

**SPECIFICATIONS**

<b>DESCRIPTION</b>	<b>VALUE</b>
<b>INPUT POWER</b>	– 100 mA – 115/230 VAC – 50 / 60 Hz
<b>STAGE 1 (relay 1 and 2) Not Fused</b>	– 10 A max; 115V/230V – 1/2 HP @ 115V – 1 HP @ 230V – Min. Rating 10mA at 115V* – 20mA at 230V*
<b>STAGE 2 (relay 3 and 4) Not Fused</b>	– 10 A max ; 115V/230V – 1/2 HP @ 115V – 1 HP @ 230V – Min. Rating 10mA at 115V* – 20mA at 230V*
<b>ALARM (dry relay contact)</b>	– 5 A ; 30V AC/DC

\*The relay will not work correctly if the charge is smaller than the minimum charge required.

Storage temperature: -4°F to 130°F (-20°C to 55°C)

Operating temperature: 32°F to 122°F (0°C to 50°C)

Weight: 5 pounds (2.25 Kg)

Dimension: 8.35"X4.60"X7.87"  
(212mmX117mmX200mm)

**RECORD FORM**

**STAGE 1**

<b>Dial</b>	<b>Option</b>	<b>Default Setting</b>		<b>User Setting</b>
2	Main Set Point	77.0°F	25.0°C	
		0.02" H <sub>2</sub> O		
3	Open Run Timer #1	3 seconds		
4	Close Run Timer #1	3 seconds		
9	Close Run Timer #2	3 seconds		
10	Open Run Timer #2	3 seconds		
11	Main Set Point	77.0°F	25.0°C	
		0.02" H <sub>2</sub> O		

**STAGE 2**

2	Differential #1	2.0°F	1.0°C	
		0.02"H <sub>2</sub> O		
3	Open Delay Timer #1	2 minutes		
4	Close Delay Timer #1	2 minutes		
5	High Temp./Pressure Alarm #1	20.0°F	12.0°C	
6	Low Temp./Pressure Alarm #1	-9.0°F	-5.0°C	
7	Low Temp./Pressure Alarm #2	-9.0°F	-5.0°C	
8	High Temp./Pressure Alarm #2	20.0°F	12.0°C	
9	Close Delay Timer #2	2 minutes		
10	Open Delay Timer #2	2 minutes		
11	Differential #2	2.0°F	1.0°C	
		0.02"H <sub>2</sub> O		

## **Limited Warranty**

The manufactured equipment and supplied components have gone through rigorous inspection to assure optimal quality of product and reliability. Individual controls are factory tested under load, however the possibility of equipment failure and/or malfunction may still exist.

For service, contact your local retailer or supplier. The warranty period shall be for two years from manufacturing date. Proof of purchase is required for warranty validation.

In all cases, the warranty shall apply only to defects in workmanship and specifically exclude any damage caused by over-voltage, short circuit, misuse, acts of vandalism, fortuitous events, acts of God, flood, fire, hail, lightning or any other natural disaster. Any unauthorized work, modification or repair on this product automatically voids the warranty and disclaims the manufacturer from all responsibility.

The manufacturer assumes only those obligations set forth herein, excluding all other warranties or obligations. This warranty stipulates that in all cases the manufacturer shall be liable only for the supply of replacement parts or goods and shall not be liable for any personal injury, damages, loss of profits, interrupted operations, fine contravention of the law or damages to the production of the PURCHASER and the PURCHASER shall take up the defense and hold the manufacturer faultless regarding any legal or extra legal proceedings, notice, or claim by the customer or by a third party, and regarding any legal and extra legal expenses and fees brought forward on by such damages.

MAV CPS-2M Ver: 4.1  
July 2001  
2-wire DC actuator